



Metasol

Meta Solution

Contactors and Overload relays
Technical Manual (Installation and Handling)

Metasol

New generation of Contactors from LSIS

This manual introduces the types, characteristics, functions and offers product selection advice for LSIS's Metasol series Magnetic Switches as well as all related standards to all the customers, managers, designers or people who are in charge of construction to be used as basic resource.

note) above article is for reference not a guarantee. SI unit system is used in this document.



- Performance
- **Breaking capacity**
- **Optimum coordination**
- **Extensive applications**

Safety Precautions

For safe use before setup, operation, maintenance, inspections carefully read this user application manual and follow its directions.

Device knowledge, safety information and precautions must be fully understood before using the device.



Danger

If you violate the contents of this “Danger” notice, it could possibly result in death or serious injury.



Warning

If you violate the contents of this “Warning” notice, it could result in injury or material loss.

Even though you read the “Danger” and “Warning” notices, in certain situations there can still be the possibility of fatal or serious results. Please carefully read each of the following rules:

- These messages the contents which are written may be changed or altered without notice
- **We are not responsible for loss caused by repair, disassembly, or alteration of our product which has not been authorized by LSIS**
- If you are considering using this product for nuclear energy control, a mobile vehicle, a traffic signal control, any sort of medical use or in other cases where high reliability is required, please contact us
- Be Cautious to prevent results such as breakdown, injury, fire damage or resulting serious damage. After reading this user and operation manual please place it in a conspicuous location where it can easily be found by users of the product. If you have some problem or fault while using this product, do refer to this manual.
- **If you have any a point in question or occur in fault, please read carefully this ‘Precautions for Handling’, and keep visible place that operator can always see this.**



Danger

1. While electricity is running, keep away from this device, and do not make contact with it, otherwise there is a danger of electrocution or being burned
2. Maintenance and alteration are only to be done after turning off the power, otherwise, there is danger of electrocution.



Warning

1. Please confirm that you have enough space to setup this device as specified in this user manual, otherwise you risk the danger of electrocution or burns.
2. Please use the designated gauge wire for distributing wires, applied voltage, current flow, and rush current. Be sure to fasten the wires according to the designated tightening torque.
3. Be sure to use this product within the range of designated specifications after confirming them, otherwise the product may cause a grounding short from insulation damage, fire from overheating, or destruction of the breaking system.
4. After finishing using the product, please dispose of it according to government law.



Contactors & Overload Relays

Contents

A	Overview	3
B	Structure and Operation	21
C	Operating Conditions	52
D	Installation	71
E	Durability	81
F	Accessories	119
G	Maintenance and Inspection	130
H	Selection and Application	143
I	Starting Type and Selection	191
J	Motor Protection and Selection of Thermal Overload Relay	205
K	Coordination	227
L	Standards	243

A. Overview

1. Product standards and approvals	4
2. Features and Range of Application	5
3. Rating and How to Order	9
4. Externals and Inscriptions	11

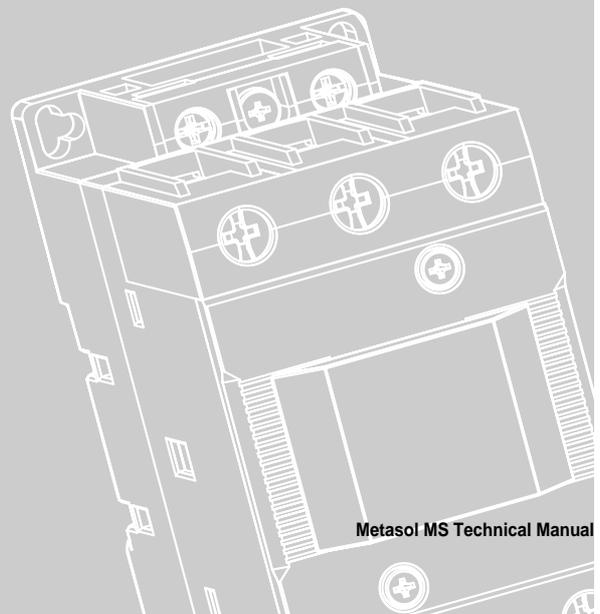

1. Product standards and approvals

Metasol-MC and MT Series Protecting Controller Adhere to the Following International Standards.

- IEC 60947-1
Low-voltage switchgear and controlgear
 - Part 1: General rules
- IEC 60947-4-1
 - Part 4-1 : Contactors and motor-starters-
Electromechanical contactors and motor-starters
- UL 508
Industrial Control Equipment

Metasol MS has Acquired the Following Certification and Can Provide it Upon Request in Certain Circumstances.

- CB Certification
- UL 508
- Safety Certification

CE Mark

The CE Mark shows that the manufacturer meets all the essential requirements of the relevant European directives to affix the CE Mark on the product.

By affixing the CE Mark, it shows that the manufacturer meets all the requirements including those of the product valuation process and authorized representative's intentions.

Requests for Certification

Requests may be made at the LS Industrial Systems Homepage Customer Service Center, use the resource center to download a copy of the certificate

- LS Industrial Systems web address: www.lsis.biz

2. Features and Range of Application

2.1 Features and Advantages

More safe, More Valuable

No arc exposure from the sealed structure
Designed to show superior technology

In order to emphasize its durability as an industrial device, Metasol series adopt simple design form and sophisticated shape applying diamond cut concepts on product surface.



Contactors & Overload Relays

- Compact design for space saving
- DIN rail and screw mountable
- Directly mountable overload relays provided separately
- Easy to combine with manual motor starters by using adapter and wiring kit
- Finger-proof design
- Broad range of accessories
- World class products conforming to IEC and UL standards

Overview

2. Features and Range of Application

2.1 Features and Advantages

Advanced Technology and Expert in Solution

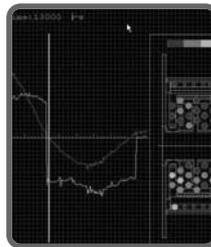

Maximize switching reliability by arc-test system

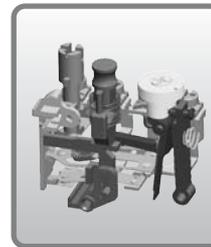

Optimization of mechanical operating by mechanism analysis

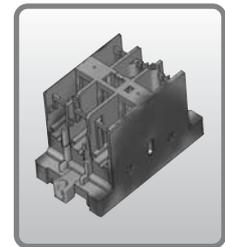

Minimize temperature rise by frame modification and air flowing analysis

Reliability & Convenience

We provide you the best reliability and economical solution with adequate design and upgrade breaking capacity

Upgrade breaking capacity

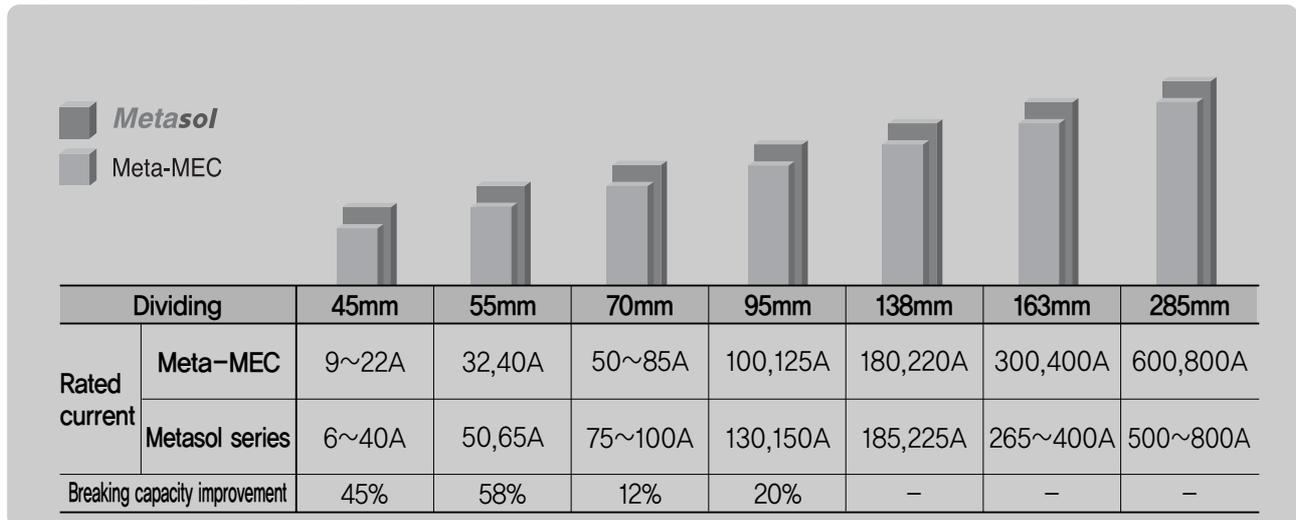

Peripheral Device, Accessories and System

Mounting structure by one-touch type

- Easy to mounting DIN Rail with our special device
- Attachment structure for surge unit and mainframe

Maximize convenience of wiring system

- Mounting unit, connector (for MC, MMS)
- Reversing wire set

Easy maintenance

- 4-terminal : offering convenience of operating coil wiring
- Design of screw terminal to module
- Interlocking unit within auxiliary switch (within 2NC)

2.2 Range of Application

Dividing	For main circuit	For main circuit		Motor control device
Type of product	ACB	MCCB		MS
Rated current	630~6300A	16~800A	3~1200A	6~800A (rated voltage 220V)
Rated breaking capacity	65~120kA (rated operational voltage 415/480V)	50~150kA (rated voltage 415V)	5~85kA (rated voltage 415V)	25~900A (rated voltage 690V)
Rated operational current standard	IEC 60947 - 2	IEC 60947 - 2	IEC 60947 - 2	IEC 60947 - 4 - 1
Image of product				
Brand Name	Metasol	Metasol	Meta-MEC	Metasol
Model name	AS, AN Series	TD, TS Series	AB Series	MC, MT Series

Overview

2. Features and Range of Application

2.3 Frame Configuration

18AF

MC : 6a, 9a, 12a, 18a
 Rated current : 6, 9, 12, 18A
 Rated insulation voltage : 690V
 Type II : 150kA @415V Max.
 (Metasol MCCB + MC)

MT : 12
 Setting current : 0.1~18A
 Trip class : Class10A, 20



22AF

MC : 9b, 12b, 18b, 22b
 Rated current : 9, 12, 18, 22A
 Rated insulation voltage : 690V
 Type II : 150kA @415V Max.
 (Metasol MCCB + MC)

MT : 32
 Setting current : 0.1~22A
 Trip class : Class10A, 20



40AF

MC : 32a, 40a
 Rated current : 32, 40A
 Rated insulation voltage : 1000V
 Type II : 150kA @415V Max.
 (Metasol MCCB + MC)

MT : 32
 Setting current : 0.1~40A
 Trip class : Class10A, 20



65AF

MC : 50a, 65a
 Rated current : 50, 65A
 Rated insulation voltage : 1000V
 Type II : 150kA @415V Max.
 (Metasol MCCB + MC)

MT : 63
 Setting current : 4~65A
 Trip class : Class10A, 20



100AF

MC : 75a, 85a, 100a
 Rated current : 75, 85, 100A
 Rated insulation voltage : 1000V
 Type II : 150kA @415V Max.
 (Metasol MCCB + MC)

MT : 95
 Setting current : 7~100A
 Trip class : Class10A, 20



150 AF

MC : 130a, 150a
 Rated current : 120, 150A
 Rated insulation voltage : 690V
 Type II : 150kA @415V Max.

MT : 150
 Setting current : 34~150A
 Trip class : Class10A, 20



225 AF

MC : 185a, 225a
 Rated current : 185, 225A
 Rated insulation voltage : 690V
 Type II : 150kA @415V Max.

MT : 225
 Setting current : 65~240A
 Trip class : Class10A, 20



400 AF

MC : 265a, 330a, 400a
 Rated current : 265, 330, 400A
 Rated insulation voltage : 690V
 Type II : 150kA @415V Max.

MT : 400
 Setting current : 85~400A
 Trip class : Class10A, 20



800 AF

MC : 500a, 630a 800a
 Rated current : 500, 630, 800A
 Rated insulation voltage : 690V
 Type II : 150kA @415V Max.

MT : 800
 Setting current : 200~800A
 Trip class : Class10A, 20



3. Rating and How to Order

3.1 Type designation system

Contactor

MC-6a	/	R	/	AC220		60Hz		1a1b
Rated current		Version		Coil voltage		Frequency		Auxiliary contact
6a 6A		- Non-differential		AC 220 AC 220V		60 60Hz		00 None
⋮		R Reversing		⋮		50 50Hz		11 1a1b
800a 800A				DC 24 DC 24V				22 2a2b
								10 1a(1NO)
								01 1b(1NC)

Switch

MS-6a	/	R		2H	/	AC220		60Hz		10	/	0.1
Rated current		Version		Version		Coil voltage		Frequency		Auxiliary contact		Relay setting current
6a 6A		- Non-differential		2H Non-differential (2-heater)		AC 220 AC 220V		60 60Hz		00 None		0.1 0.1 A
⋮		R Reversing		3H Non-differential (3-heater)		⋮		50 50Hz		11 1a1b		⋮
800a 800A				3K Differential		DC 24 DC 24V				22 2a2b		⋮
				3D Class 20						10 1a(1NO)		800 800A
										01 1b(1NC)		

Thermal Overload Relay

MT-12	/	2H		0.1
Frame size		Version		Relay setting current
12 12AF		2H Non-differential (2-heater)		0.1 0.1 A
32 32AF		3H Non-differential (3-heater)		⋮
63 63AF		3K Differential		800 800A
95 95AF		3D Class 20		
⋮				
800 800AF				

Overview

3. Rating and How to Order

3.1 Type designation system

Option

Auxiliary contact unit

UA-1	
Version	
UA-1 AU-100	Side mount
AU-2	Front mount(2P)
AU-4	Front mount(4P)

AU-2, AU-4 are compatible with Meta-MEC.
 AU-2 (Auxiliary contact unit) : 2a, 1a1b, 2b
 AU-4 (Auxiliary contact unit) : 4a, 3a1b, 2a2b, 1a3b, 4b

11	
Contact composition	
11	1NO+1NC
20	2NO
02	2NC
40	4NO
31	3NO+1NC
22	2NO+2NC
13	1NO+3NC
04	4NC

Surge absorber

US11					
Composition and voltage					
1	Varistor+RC	AC/DC 24~48V	11	Varistor	AC 200~240V
2	Varistor+RC	AC/DC 100~125V	12	Varistor	DC 24~48V
3	Varistor+RC	AC/DC 200~240V	13	Varistor	DC 100~125V
4	Varistor+RC	AC 380~440V	14	Varistor	DC 200~220V
5	Varistor+RC	AC 24~48V	22	RC	AC 100~125V
6	Varistor+RC	AC 100~125V			

Interlock unit

UR02	
Contact composition	
02	2NC
00	None

Wire kit for Interlocking

UW32	
Frame size	
18	18AF
22	22AF
32	32AF
63	63AF
95	95AF

Interlock set (UR + UW)

RK32	
Frame size	
32	32AF
63	63AF
95	95AF

Separate mounting unit (For relay)

UZ32	
Frame size	
32	32AF
63	63AF
95	95AF
150	150AF

Remote reset unit (For relay)

UM	
Cable length	
4R	400
5R	500
6R	600

4. Externals and Inscriptions

4.1 External Structure & Marking

1) External structure

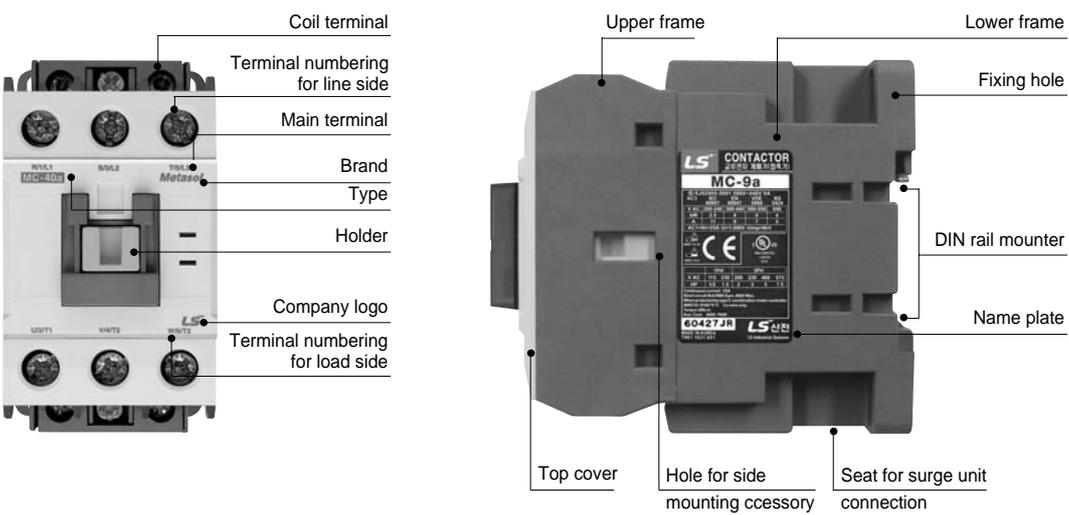

2) Marking

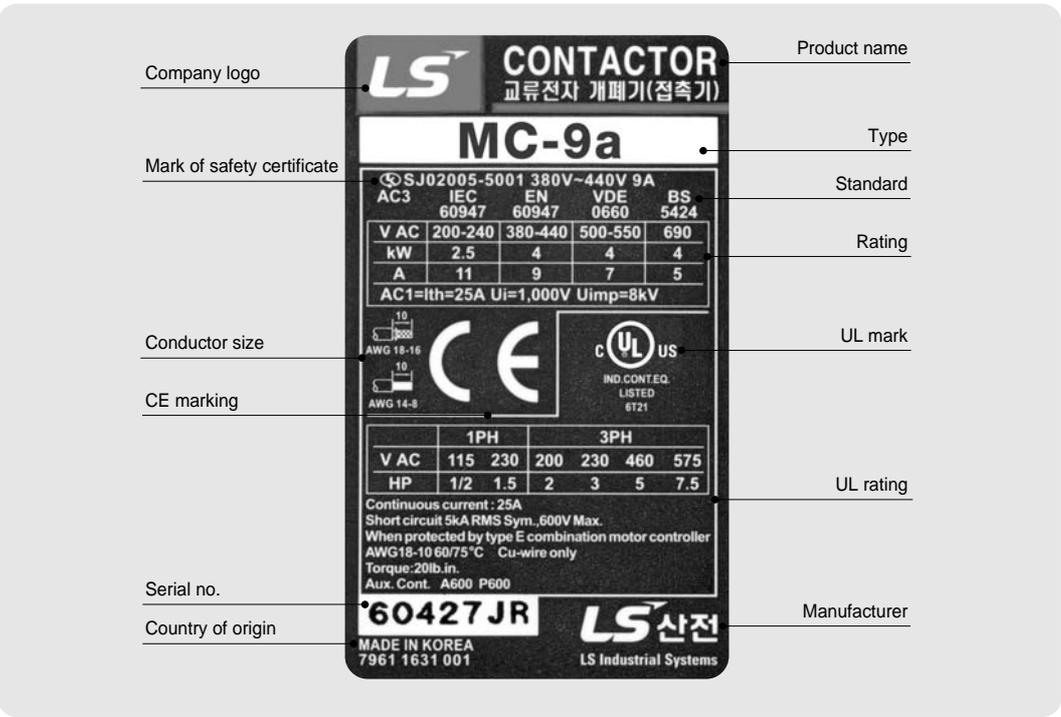

Overview

4. Externals and Inscriptions

4.2 Accessories

18AF

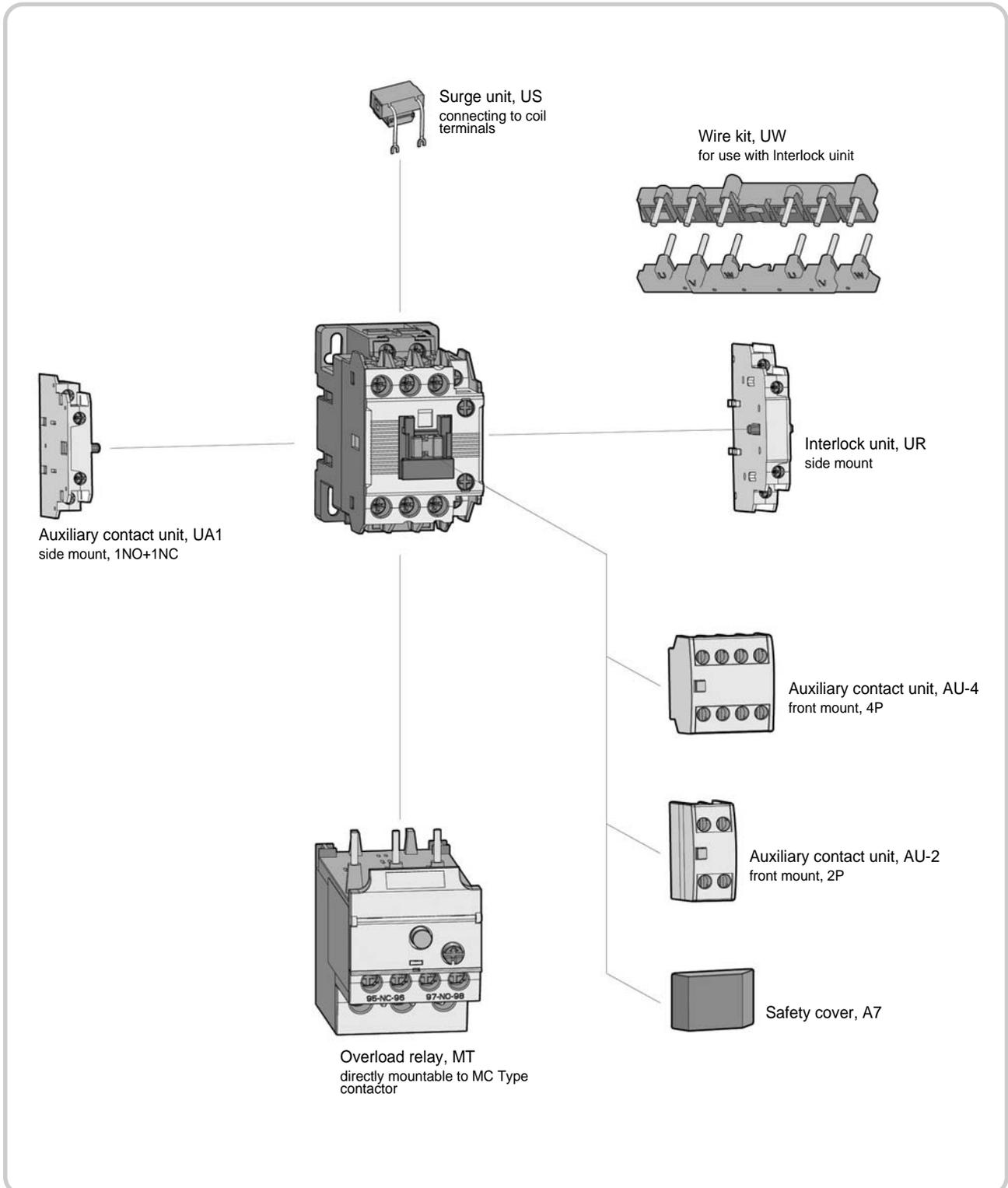

A

■ 22AF

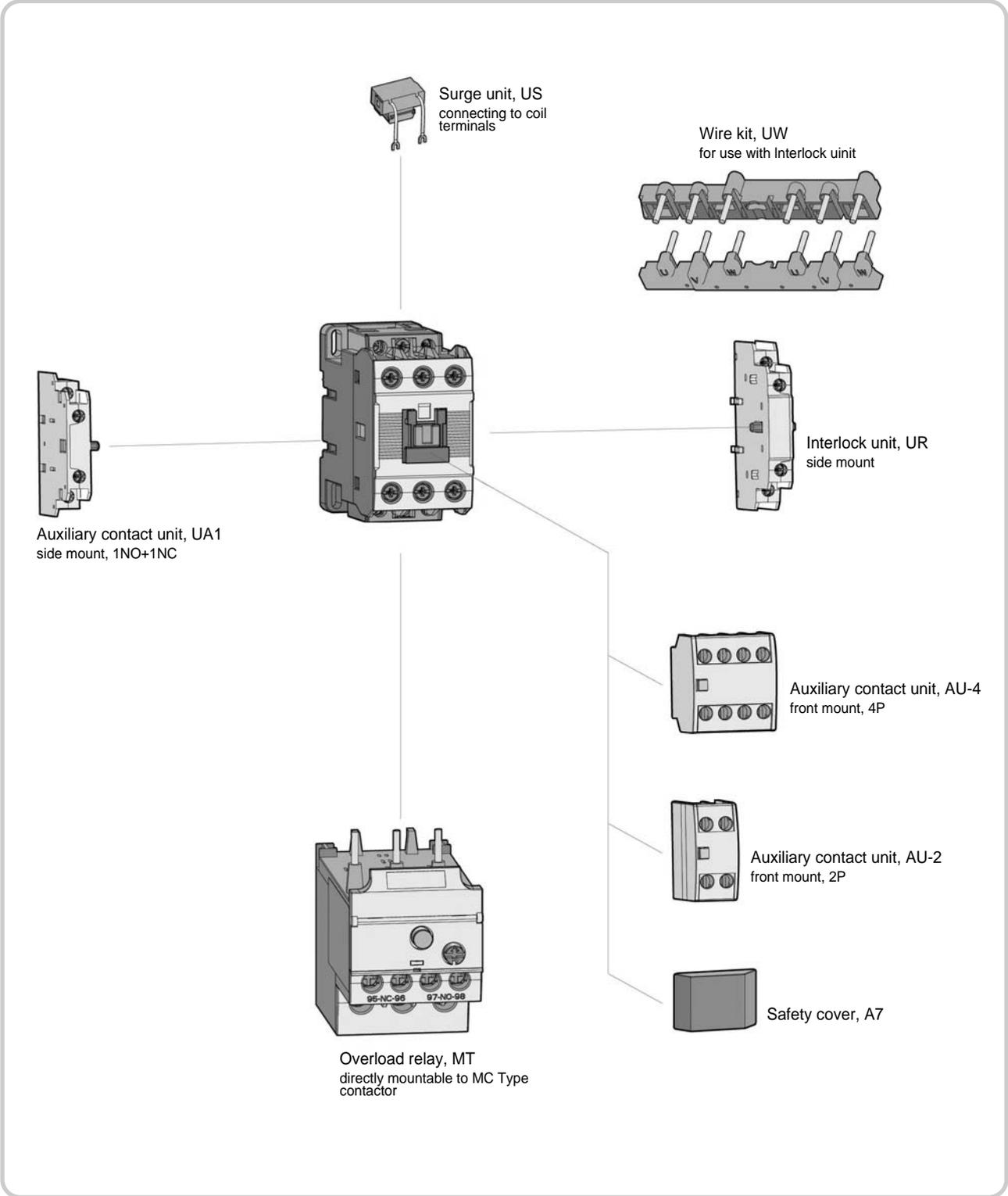

Overview

4. Externals and Inscriptions

4.2 Accessories

40AF

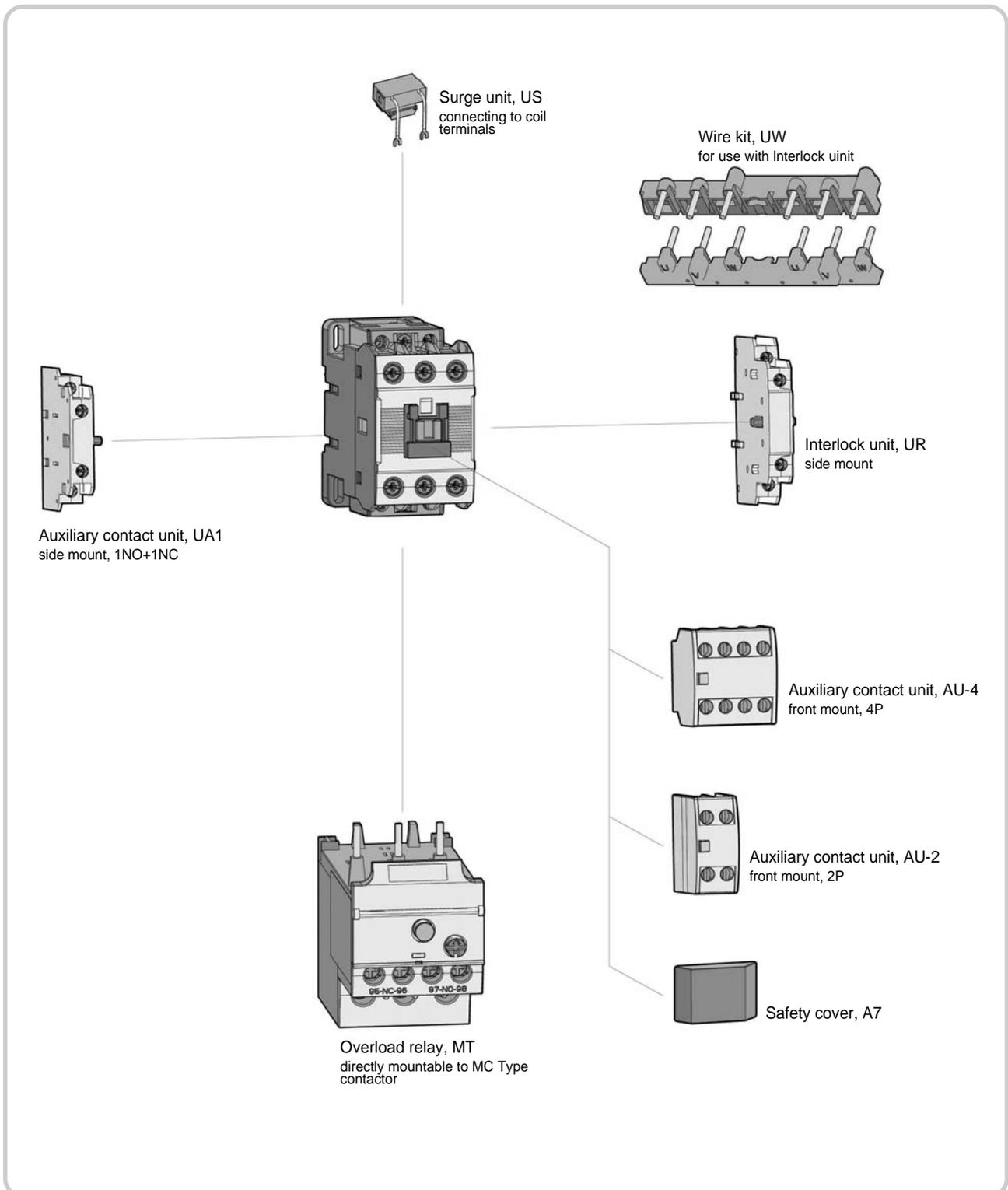

■ 65AF

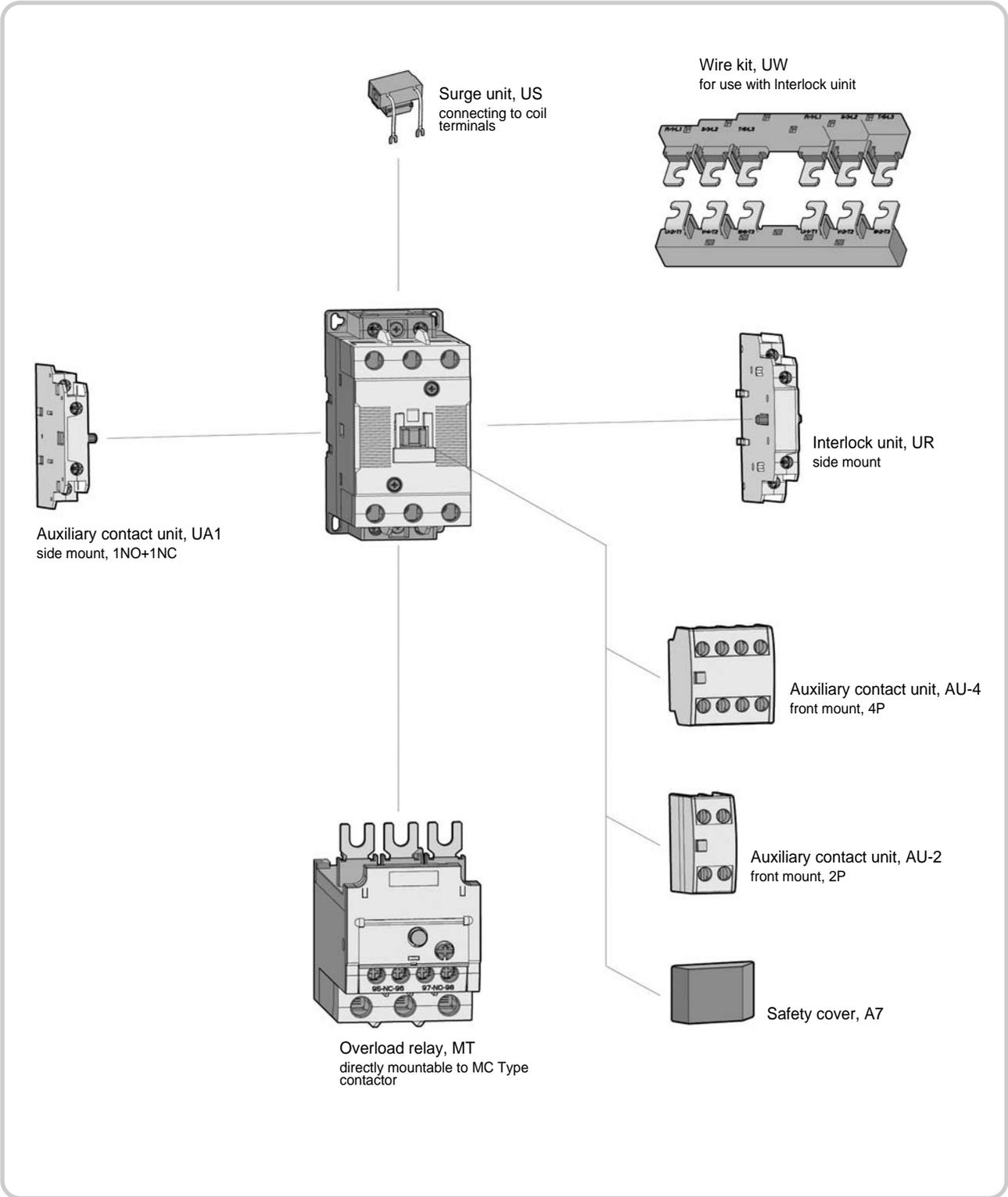

A

Overview

4. Externals and Inscriptions

4.2 Accessories

100AF

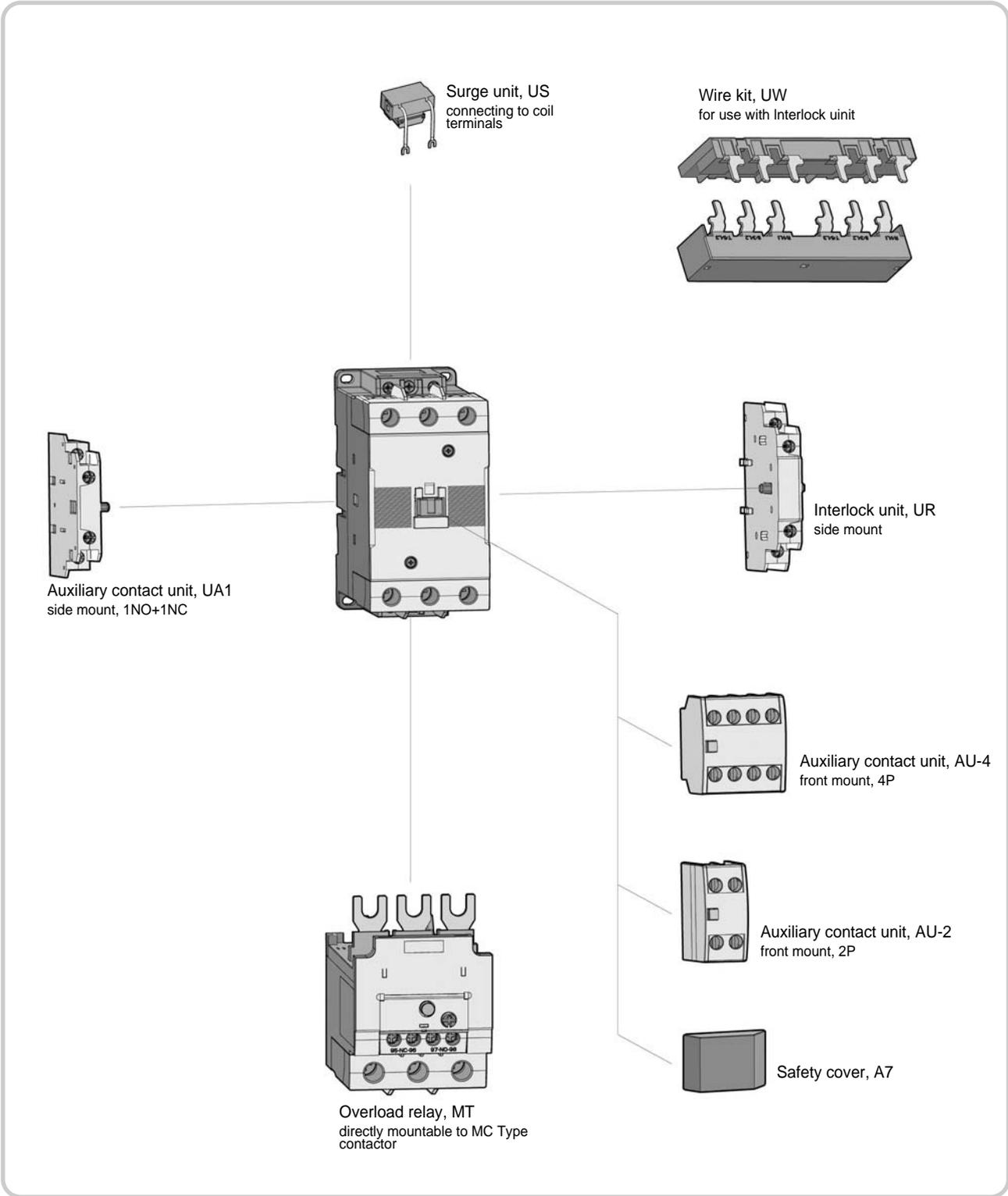

A

■ 150AF

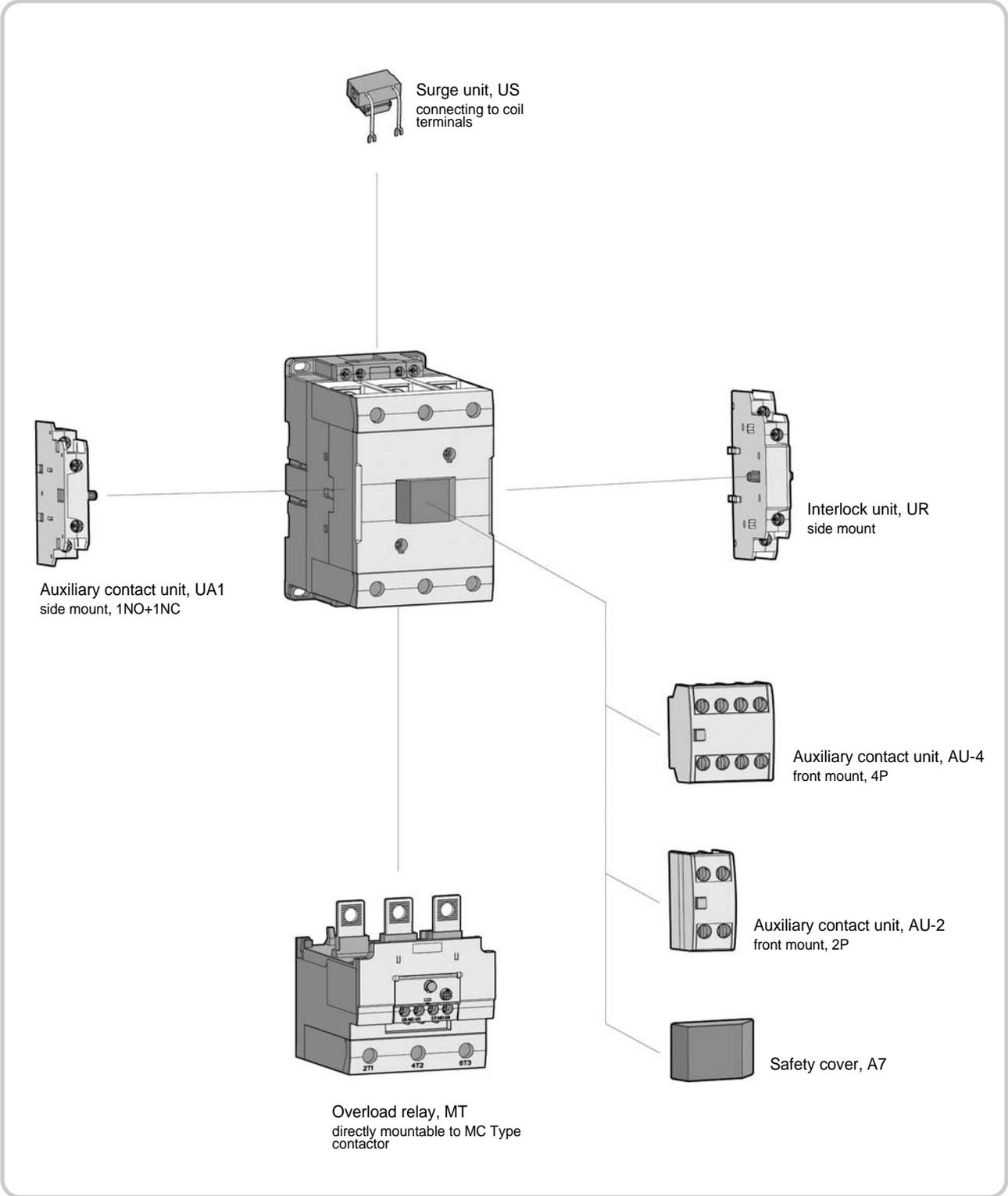

4. Externals and Inscriptions

4.2 Accessories

225AF

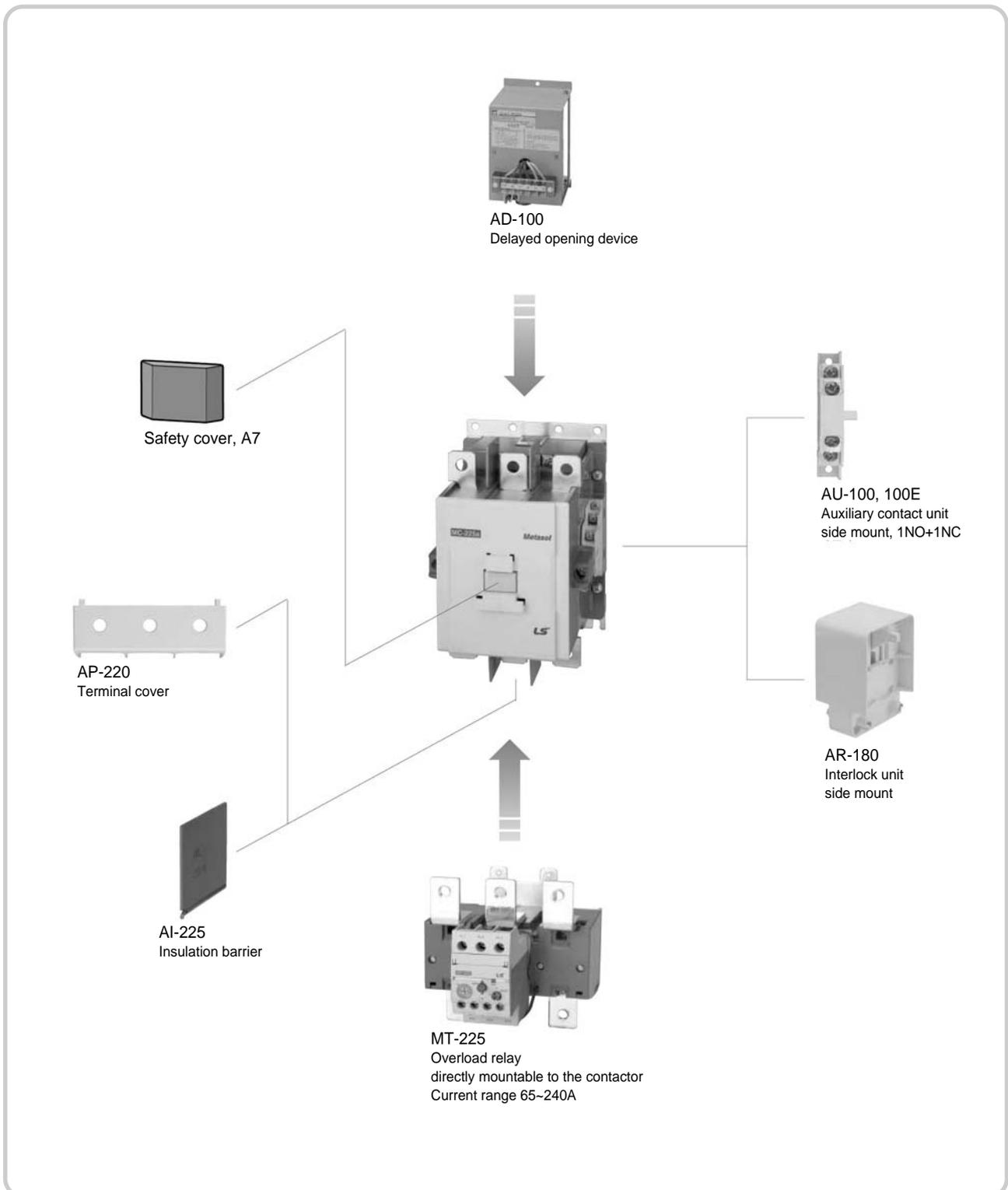

A

■ 400AF

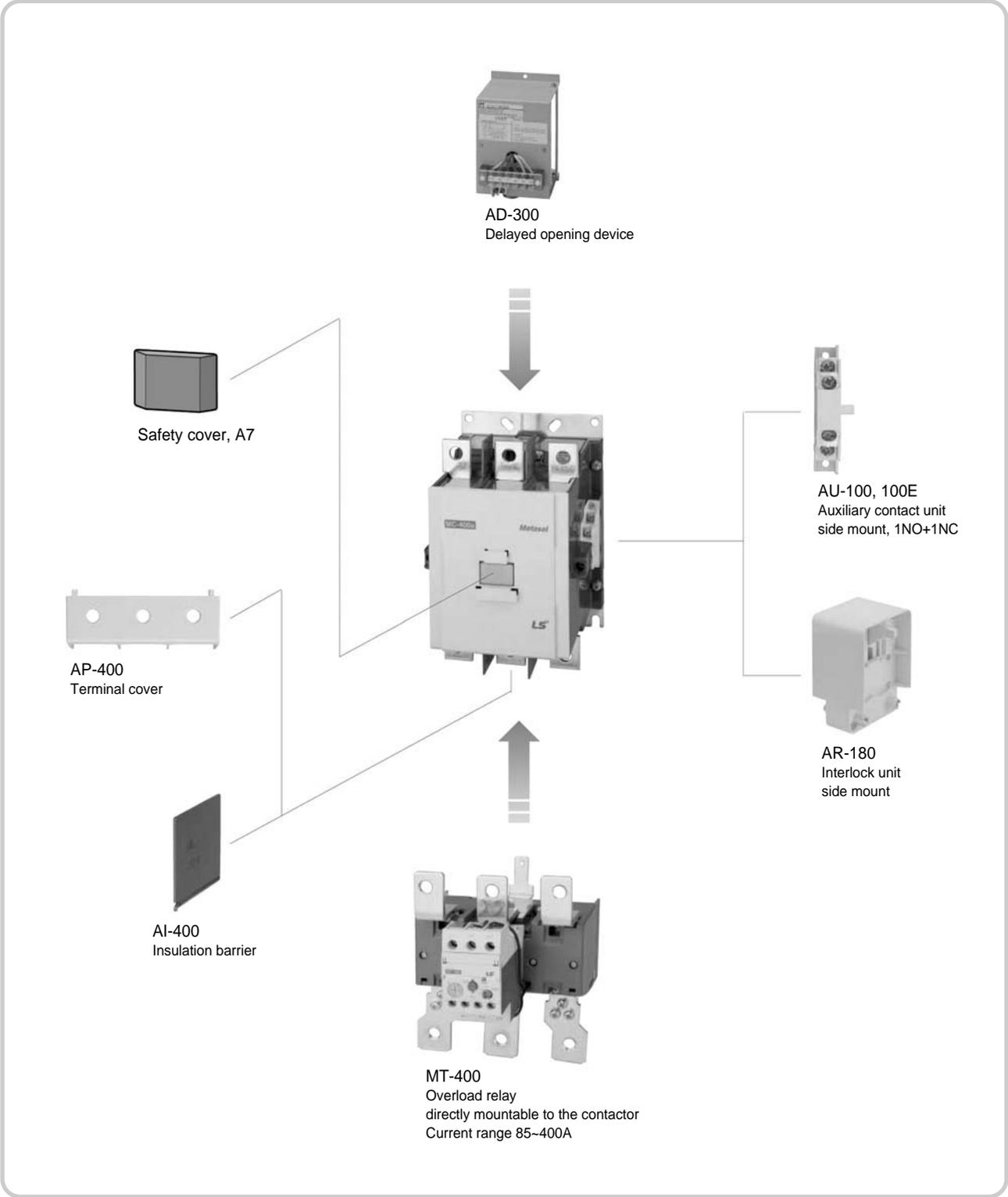

4. Externals and Inscriptions

4.2 Accessories

800AF

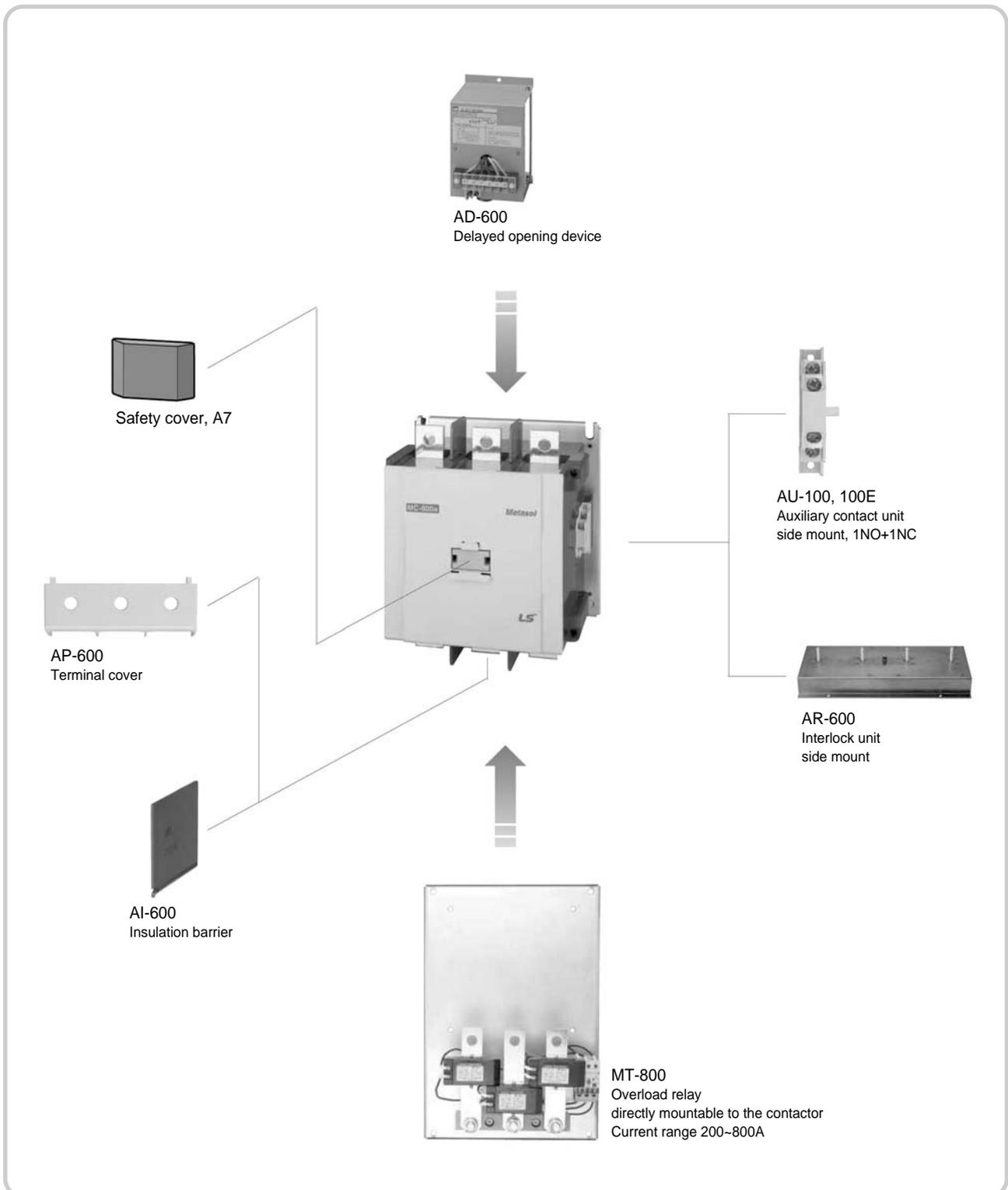

B. Structure and Operation

1. Structure	22
2. Theory of Activation	25
3. Table of specifications	45

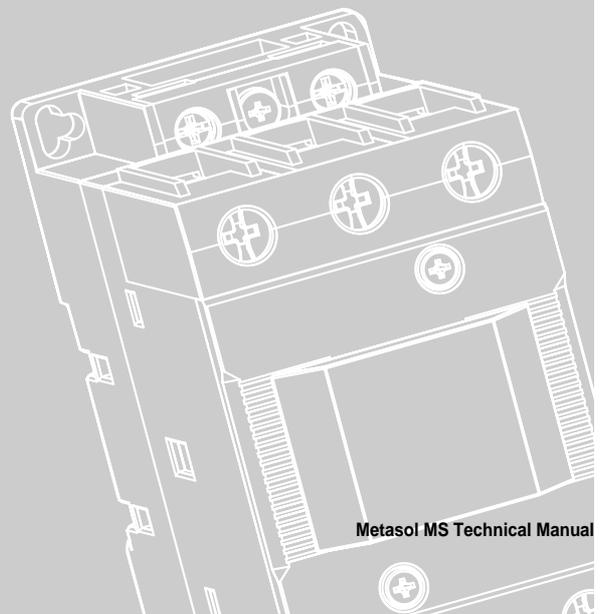

Structure and Operation

1. Structure

1.1 Magnetic Switch

The magnetic switch is generally used for motor circuits and it has some functions to protect from overloading currents of open and close circuits and motors. The magnetic switch consists of a thermal overload Relay (TOR) which protects motors from overloads and opening and closing the contactor with opening and closing electronic circuits.

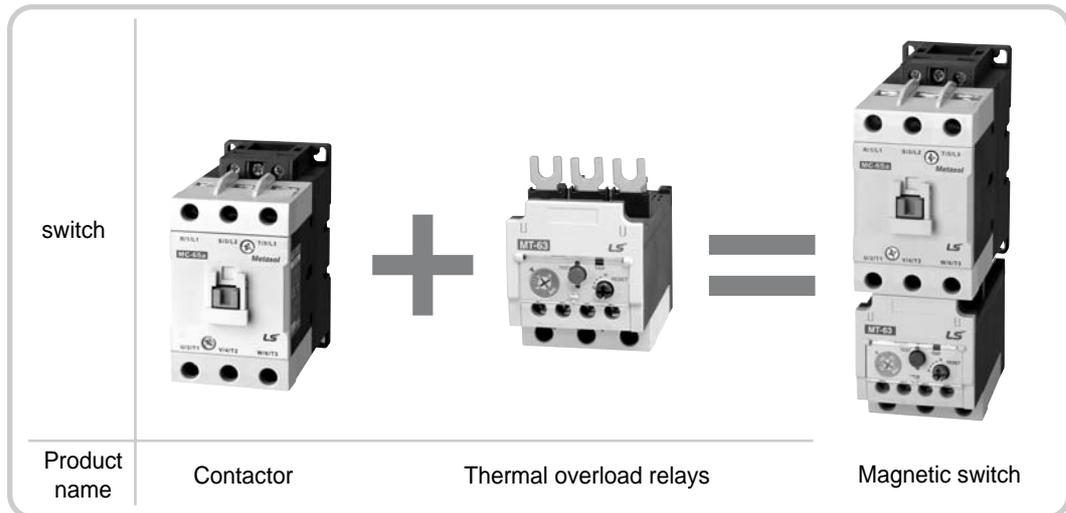

Fig. 1. Magnetic Switch

Characteristics of a magnetic switch

1. Possible automatic control

With other control device, Control relays, timers, limit switches, optical switches, etc. it can be completely combined with such other devices, and motor control is automatically possible.

2. Possible remote control

The Magnetic switch can be operated remotely by being remotely setup and being activated by an on and off control switch.

3. Concentration control

When we need to control the motors which are setup individually we can manipulate them with a magnetic switch by putting them together in one place.

4. Stability of control

It is possible to apply this control at various loading capacities, from tens of Amps to hundreds of Amps, and from 220V to 440V of a motor' main circuit voltage. Stable manipulation is possible because the coil voltage which is operating the magnetic switch consumes less power.

5. Maximum durability

Metasol magnetic contactor is guaranteed mechanically from 1200 to 1500 cycles, and electrically from 200 to 250 cycles.

6. Maximum switch frequency

It is possible from 100 cycles to 1000 cycles of on and off switching per hour.

7. Overload protection

Overload protection is adequate for protecting from overloaded open phase or short and also for operating over a long driving time.

8. Automatic compensation for surrounding temperature

A bimetal which compensates for surrounding temperature is equipped inside the TOR.

1.2 Magnetic Contactor

The basic structure of the MC-6a type magnetic contactor to MC-100a type has the same acting structure especially considering the reduction of hazardous substances directive (RoHS) regarding every metal and molded part, environmentally friendly basic materials or parts are used. The on/off contacting part has a sealed structure at the contact point which hides arcing and improves efficiency and durability of the circuit breaker. Through electric field analysis we have improved current capacity, resistance against melting and fusing for the contact point, and optimizing the design for anti-arc characteristics. The sub-contact part is manufactured and supplied from existing single-body type and separable-type, as side-On type and head-On type, so that customers can select them according to their needs.

Structure

The main components of a magnetic contactor are the contactor part and the magnetic point. The contactor part consists of the moving contact point and the fixed contact point. The magnetic point consists of the operating coil and an iron core.

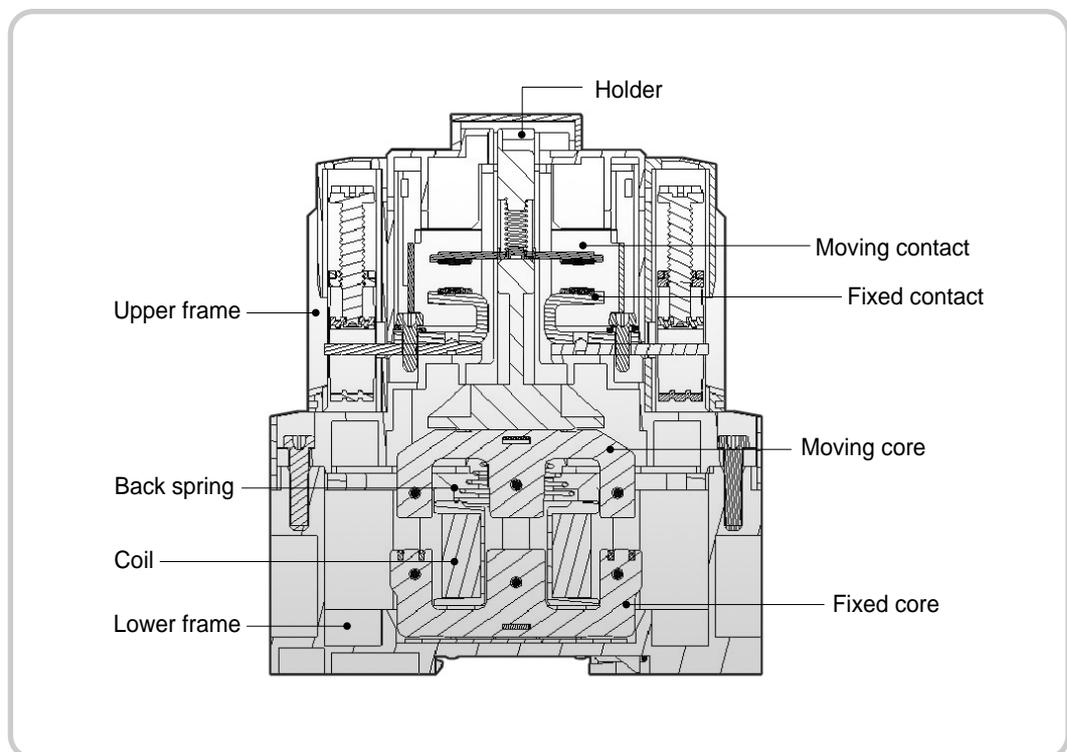

Fig. 2. Structure of magnetic contactor

Main structure and component names and functions

1. Electromagnet

It can attract the Moving core by controlling the attraction force. It does this by deriving magnetic flux from running current through the coil installed around the core.

2. Coil

In order to derive magnetic flux the coil is installed around the core, derived magnetic flux changes by frequency, but in the small devices, it can be applied with one coil at 50, 60Hz

3. Switching part

It is a part breaking or flowing a load current and consists of a Moving point, a fixed point and grid it has a structure to send arc to the grid and make the arc discharge by making use of electromagnetic force for breaking circuits quickly derived by running current.

Structure and Operation

1. Structure

1.3 Thermal Overload Relay

The thermal overload relay prevents damage and loss of motor from overload and constraint conditions. In consideration of the Reduction of Hazardous Substances Directive (RoHS) regarding every metal and molded part, environmentally friendly basic materials or parts are used in manufacturing the TOR. The structure has a heater element assembly bimetal and heating trigger as a thermal element, shown in fig.3. It is combined with a preventative trip mechanism, running current can be controlled by an upper control dial, the heating trigger consists of element two and element three and contact point consists of 1A1B, in case of breaking the circuit it can improve the overcurrent handling strength, it can prevent against mis-activation when driving.

■ Structure

The main components of the TOR consist of the heater element, which is made up of the heater and bimetal part, it also consists of a control dial to set the TOR running current, and a contact point which produces an electrical signal of the running condition.

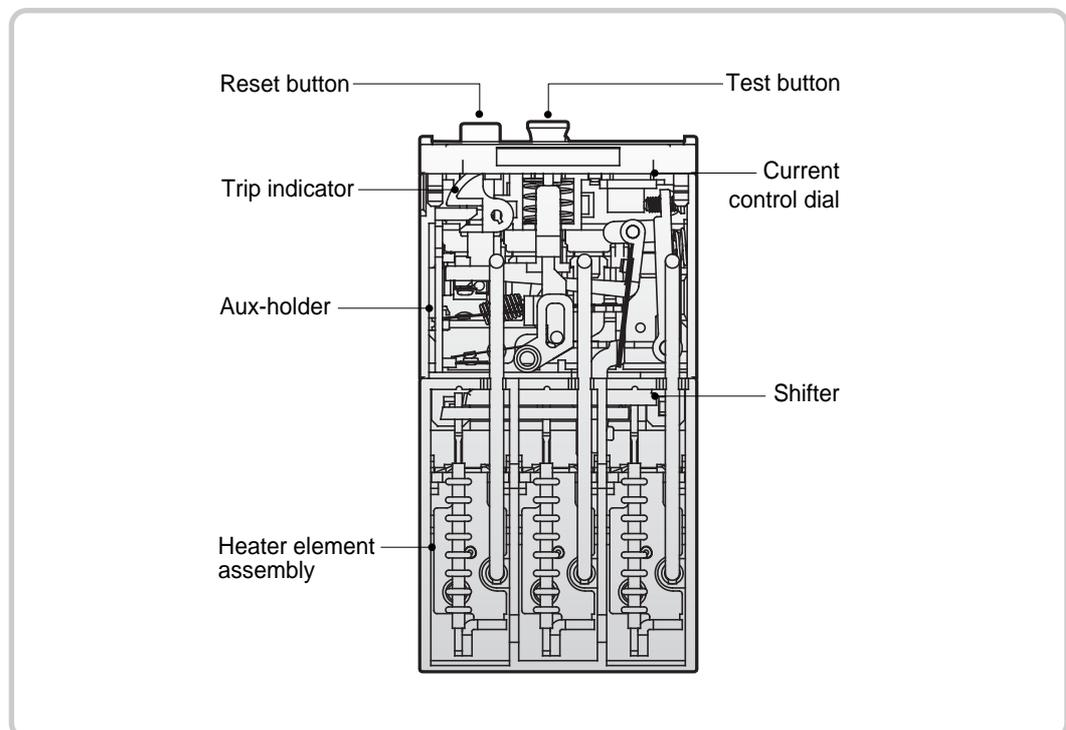

Fig. 3. Structure of thermal overload relay

■ Main structure, component names and functions

1. Bimetal

The bimetal is a combination of two different metals with different thermal expansion coefficients which are bonded together. This results in a bending characteristic corresponding to certain temperature variations. It is used as a trigger when the TOR is operating.

2. Bimetal compensation of surrounding temperature

The Bimetal bends under surrounding temperature variations, for example, if the surrounding temperature flares up, the action is faster to prevent further overheating. By installing a compensating bimetal which will bend in the same direction as the main bimetal we can maintain the interval of contact point action consistently with the amount of rising temperature.

2. Theory of Activation

2.1 Activation Theory of Magnetic Contactor

The magnetic contactor consists of an on/off contact point of the electrical circuit which provides electricity to the motor load, an electromagnet completed from on/off acting control coil and an iron core and a connecting device sending the movement of electromagnet to the contact point. If there is standard voltage at the coil, the excitation current runs, magnetic flux is derived from inside the fixed iron core. This causes the fixed iron core to become a magnet, causing the moving core to be pulled toward the fixed iron core. In the holder connected with a pin to this moving core, the moving contact point is assembled and it moves together with the moving core, contacts with the fixed contact point at the frame and then closes the circuit. If breaking the voltage is permitted in the coil, excitation of the iron core is released and the moving core is repulsed again by the back spring. At the same time the moving contact point escapes from the fixed contact point and the circuit is broken.

When coil circuit is off

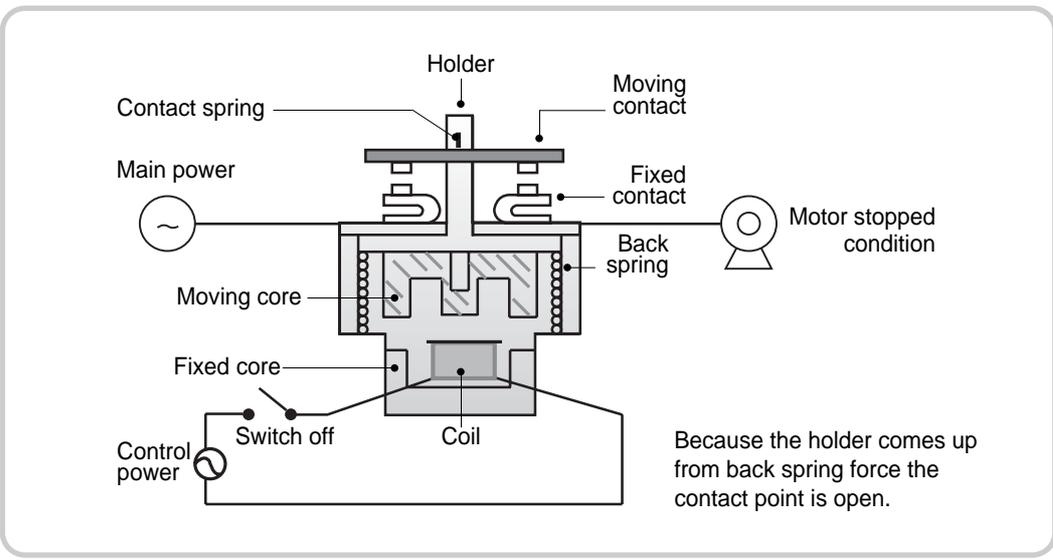

Fig. 4. Theory of activation of MC (while stopped)

When coil circuit is on

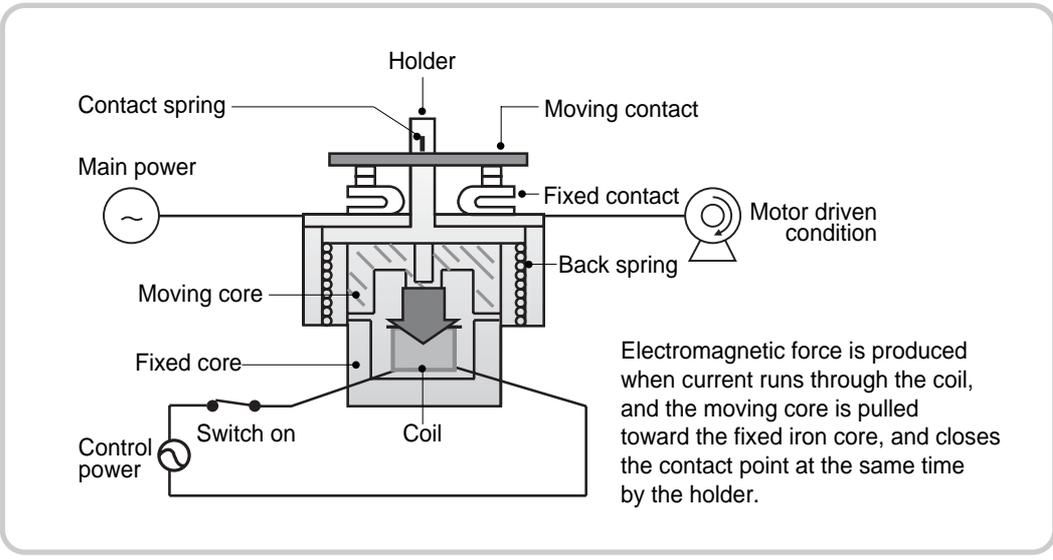

Fig. 5. The theory of activation of MC (while driving)

B

Structure and Operation

2. Theory of Activation

2.2 Internal Structure

1) MC-18a Magnetic contactors

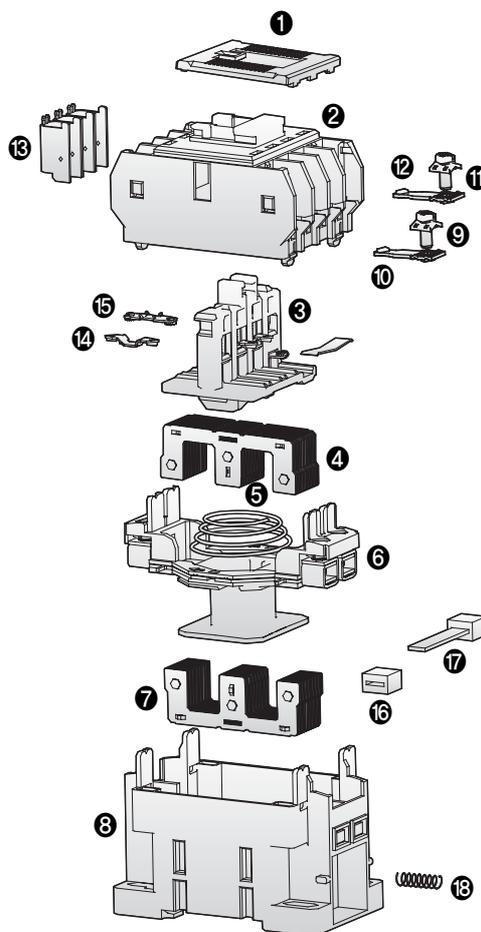

- ① Top cover
- ② Upper frame
- ③ Holder
- ④ Moving core
- ⑤ Back spring
- ⑥ Coil assembly

- ⑦ Fixed core
- ⑧ Lower frame
- ⑨ Terminal screw
- ⑩ Fixed contact
- ⑪ Aux Terminal screw
- ⑫ Aux, fixed contact

- ⑬ Grid
- ⑭ Moving contact
- ⑮ Aux moving contact
- ⑯ Bobbm cushion
- ⑰ Core supporter
- ⑱ Latch spring

B

2) MC-22a Magnetic contactors

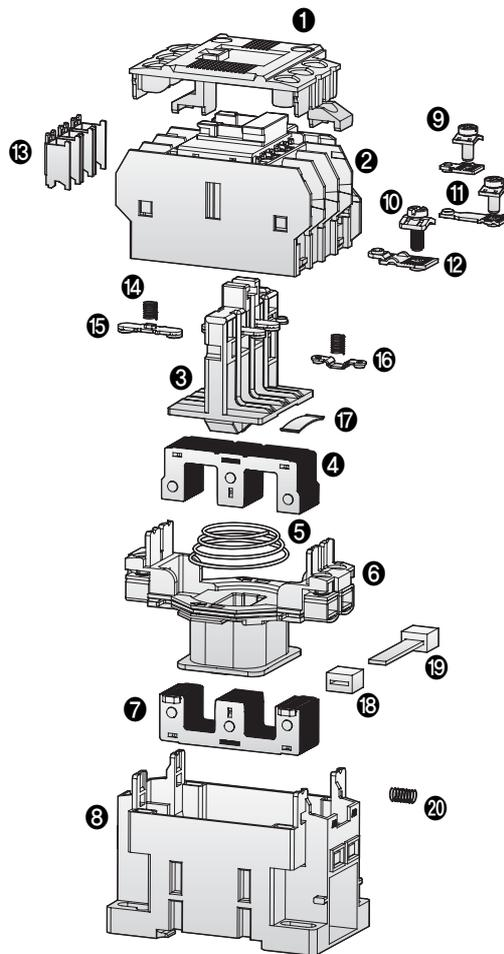

- | | | |
|-----------------|----------------------|-------------------------|
| ① Top cover | ⑨ Aux Terminal screw | ⑰ Supporter moving core |
| ② Upper frame | ⑩ Terminal screw | ⑱ Bobbin cushion |
| ③ Holder | ⑪ Aux, fixed contact | ⑲ Supporter fixed core |
| ④ Moving core | ⑫ Fixed contact | ⑳ Latch spring |
| ⑤ Back spring | ⑬ Grid | |
| ⑥ Coil assembly | ⑭ Contact spring | |
| ⑦ Fixed core | ⑮ Moving contact | |
| ⑧ Lower frame | ⑯ Aux moving contact | |

Structure and Operation

2. Theory of Activation

2.2 Internal Structure

3) MC-40a Magnetic contactors

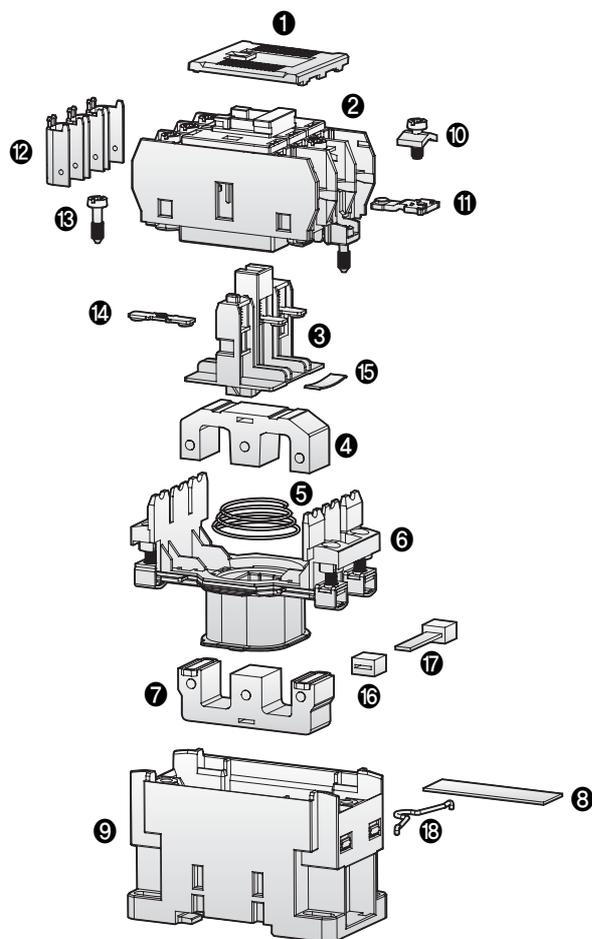

- ① Top cover
- ② Upper frame
- ③ Holder
- ④ Moving core
- ⑤ Back spring
- ⑥ Coil assembly

- ⑦ Fixed core
- ⑧ Cushion fixed core
- ⑨ Lower frame
- ⑩ Terminal screw
- ⑪ Fixed contact
- ⑫ Grid

- ⑬ Screw tapping
- ⑭ Moving Contact
- ⑮ Supporter moving core
- ⑯ Bobbin cushion
- ⑰ Core supporter
- ⑱ Latch spring

B

4) MC-65a Magnetic contactors

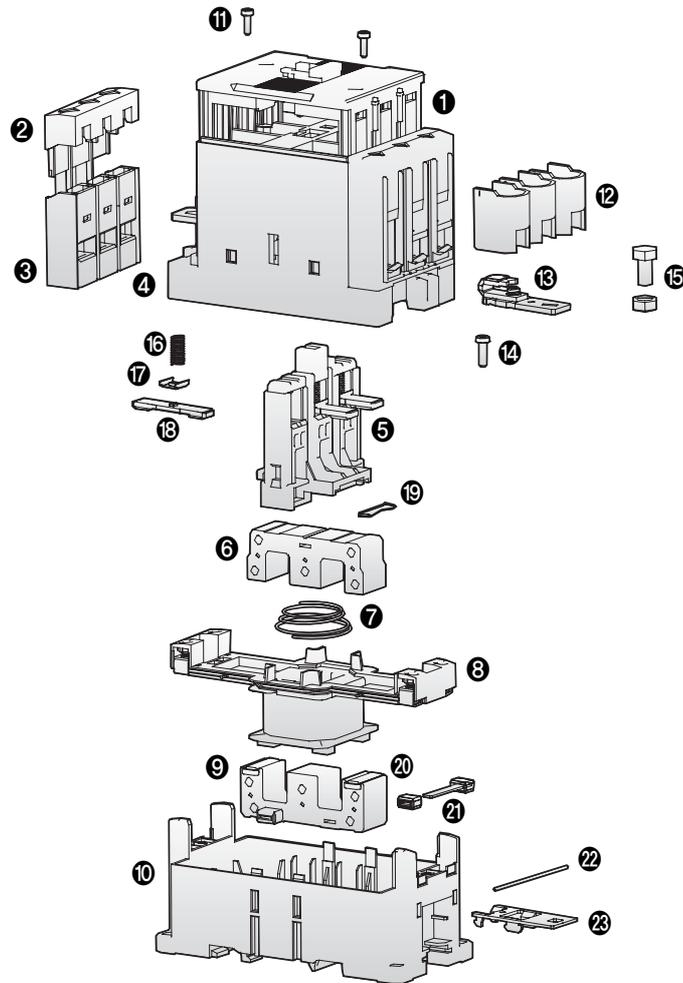

- | | | |
|-----------------|---------------------|--------------------------|
| 1 Top cover | 9 Fixed core | 17 Spring supporter |
| 2 Screw cover | 10 Lower frame | 18 Moving contact |
| 3 Screw case | 11 M3 Screw tapping | 19 Supporter moving core |
| 4 Upper frame | 12 Grid | 20 Bobbin cushion |
| 5 Holder | 13 Fixed contact | 21 Supporter fixed core |
| 6 Moving core | 14 M4 Screw tapping | 22 Latch spring |
| 7 Back spring | 15 Bolt / Nut | 23 Cushion fixed core |
| 8 Coil assembly | 16 Contact Spring | |

Structure and Operation

2. Theory of Activation

2.2 Internal Structure

5) MC-100a Magnetic contactors

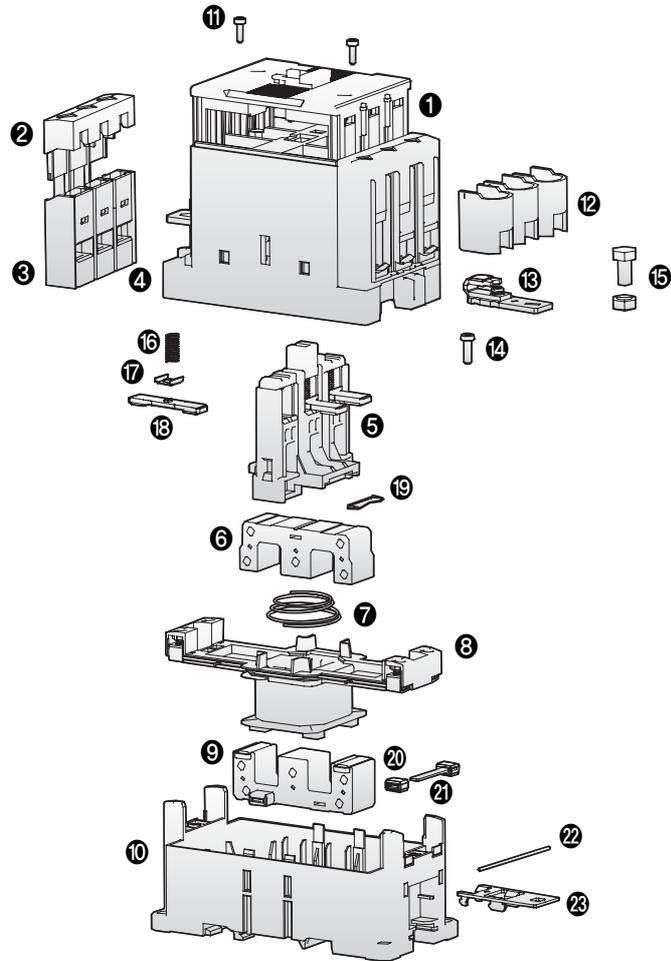

- | | | |
|-----------------|--------------------|-------------------------|
| ① Top cover | ⑨ Fixed core | ⑰ Spring supporter |
| ② Screw cover | ⑩ Lower frame | ⑱ Moving contact |
| ③ Screw case | ⑪ M3 Screw tapping | ⑲ Supporter moving core |
| ④ Upper frame | ⑫ Grid | ⑳ Bobbin cushion |
| ⑤ Holder | ⑬ Fixed contact | ㉑ Supporter fixed core |
| ⑥ Moving core | ⑭ M4 Screw tapping | ㉒ Latch spring |
| ⑦ Back spring | ⑮ Bolt / Nut | ㉓ Cushion fixed core |
| ⑧ Coil assembly | ⑯ Contact Spring | |

B

6) MC-150a Magnetic contactors

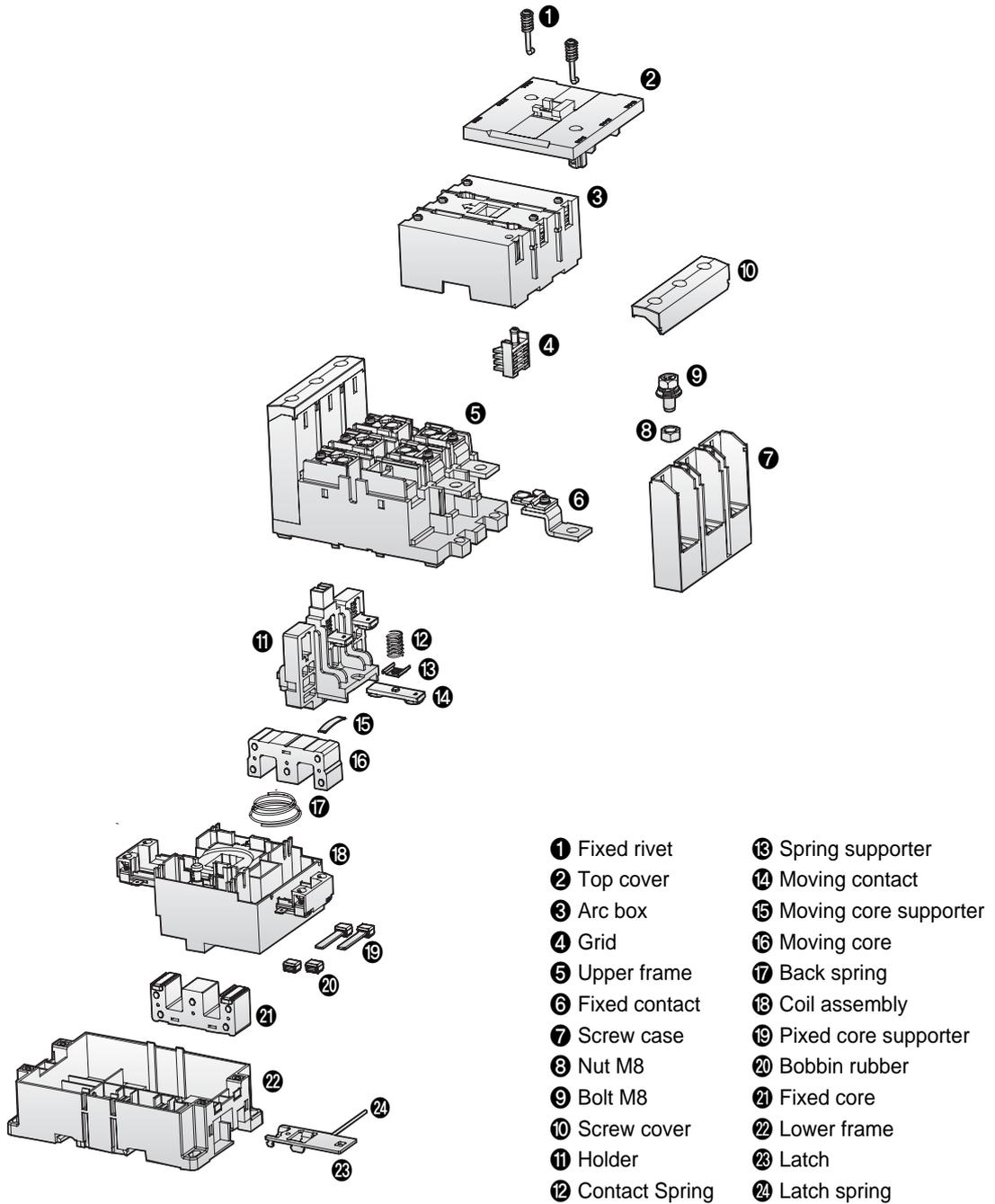

Structure and Operation

2. Theory of Activation

2.2 Internal Structure

7) MT-12 Thermal overload relays

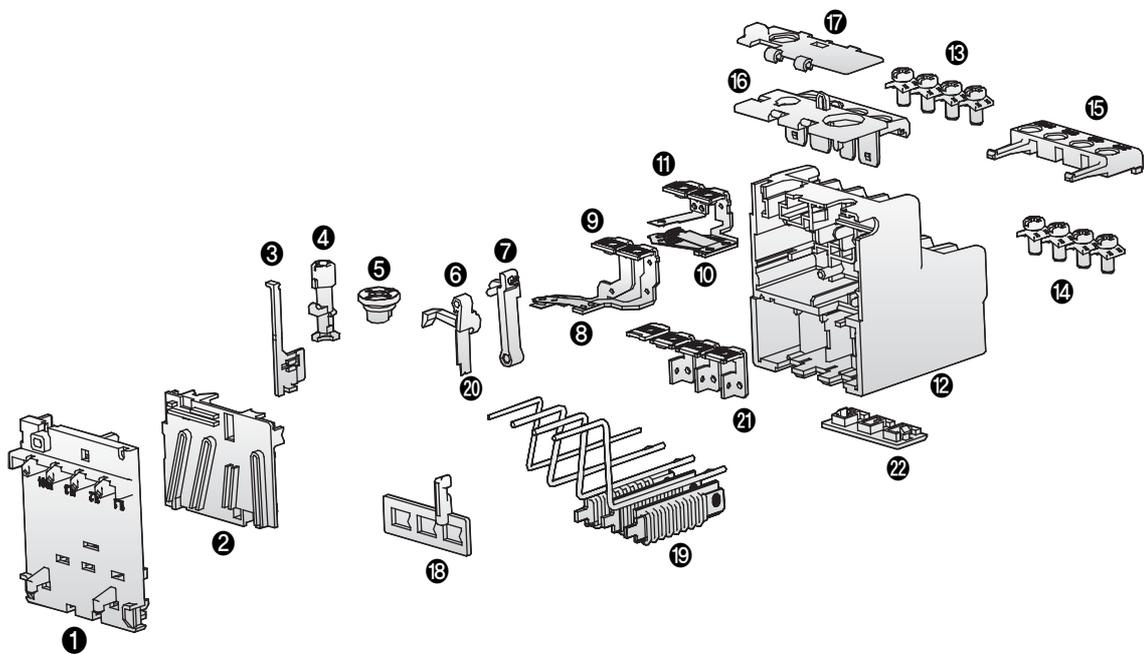

- | | | |
|-----------------|----------------------|-------------------|
| ① Back cover | ⑩ 97 Terminal | ⑲ Heater assembly |
| ② Aux cover | ⑪ 98 Terminal | ⑳ Aux Connector |
| ③ Test button | ⑫ Heater case | ㉑ Main cover |
| ④ Reset button | ⑬ Aux Terminal screw | ㉒ Bottom cover |
| ⑤ Dial | ⑭ Terminal screw | |
| ⑥ Reset lever | ⑮ Terminal cover | |
| ⑦ Link assembly | ⑯ Shifter | |
| ⑧ 95 Terminal | | |
| ⑨ 96 Terminal | | |

8) MT-32 Thermal overload relays

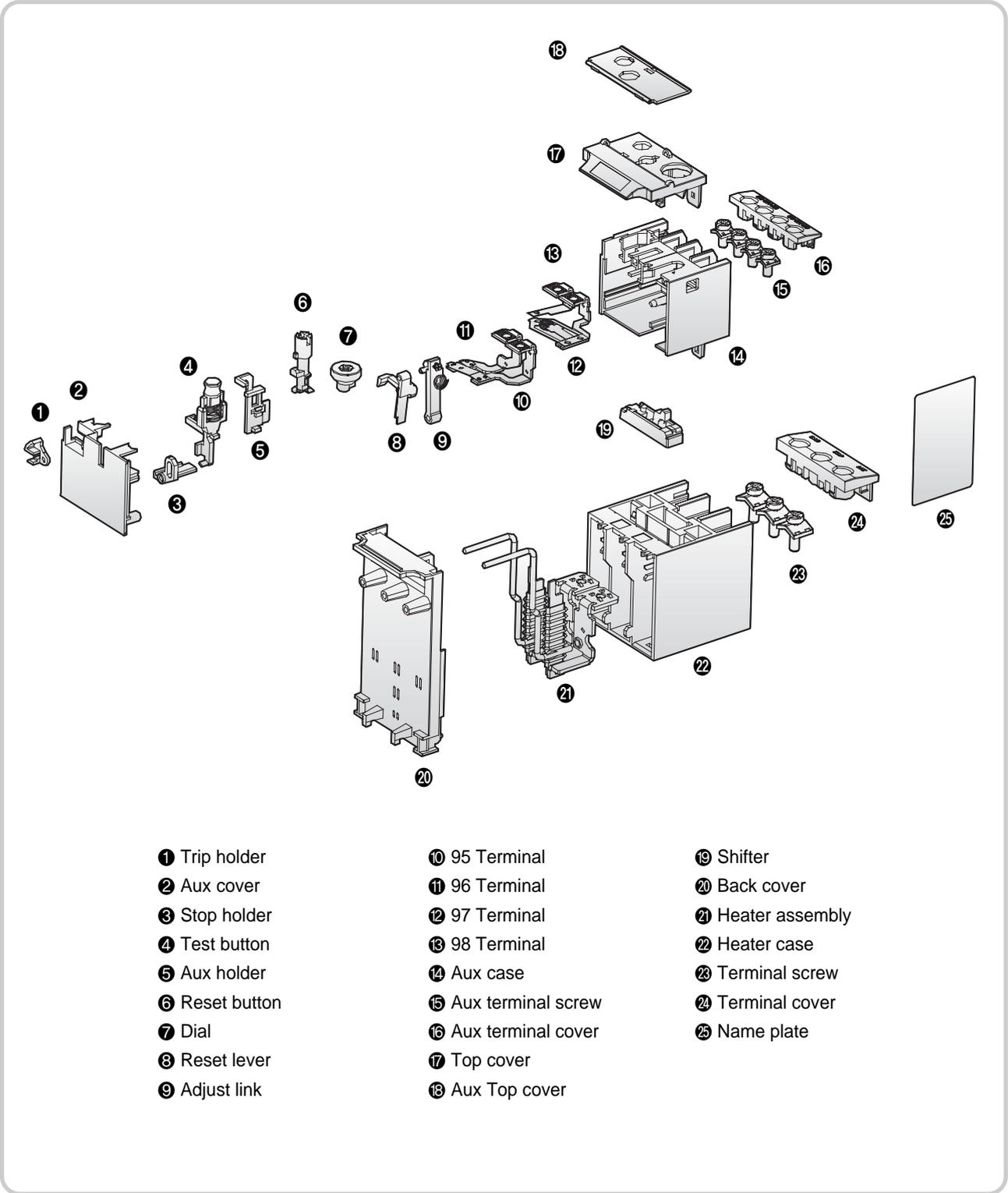

- 1 Trip holder
- 2 Aux cover
- 3 Stop holder
- 4 Test button
- 5 Aux holder
- 6 Reset button
- 7 Dial
- 8 Reset lever
- 9 Adjust link
- 10 95 Terminal
- 11 96 Terminal
- 12 97 Terminal
- 13 98 Terminal
- 14 Aux case
- 15 Aux terminal screw
- 16 Aux terminal cover
- 17 Top cover
- 18 Aux Top cover
- 19 Shifter
- 20 Back cover
- 21 Heater assembly
- 22 Heater case
- 23 Terminal screw
- 24 Terminal cover
- 25 Name plate

B

Structure and Operation

2. Theory of Activation

2.2 Internal Structure

9) MT-63 Thermal overload relays

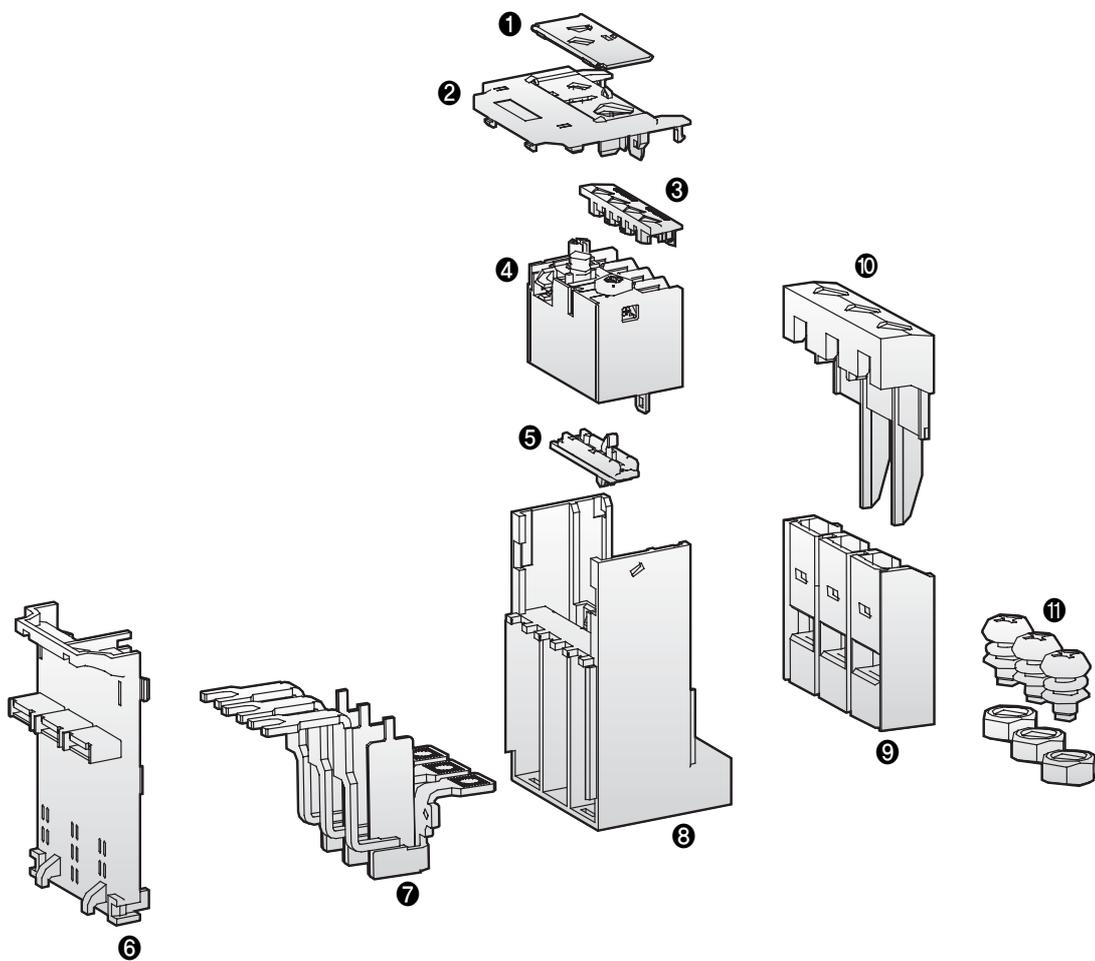

- ① Name plate
- ② Top cover
- ③ Aux terminal cover
- ④ Aux case assembly

- ⑤ Shifter
- ⑥ Back cover
- ⑦ Heater assembly
- ⑧ Heater case

- ⑨ Screw case
- ⑩ Screw case cover
- ⑪ Screw assembly

B

10) MT-95 Thermal overload relays

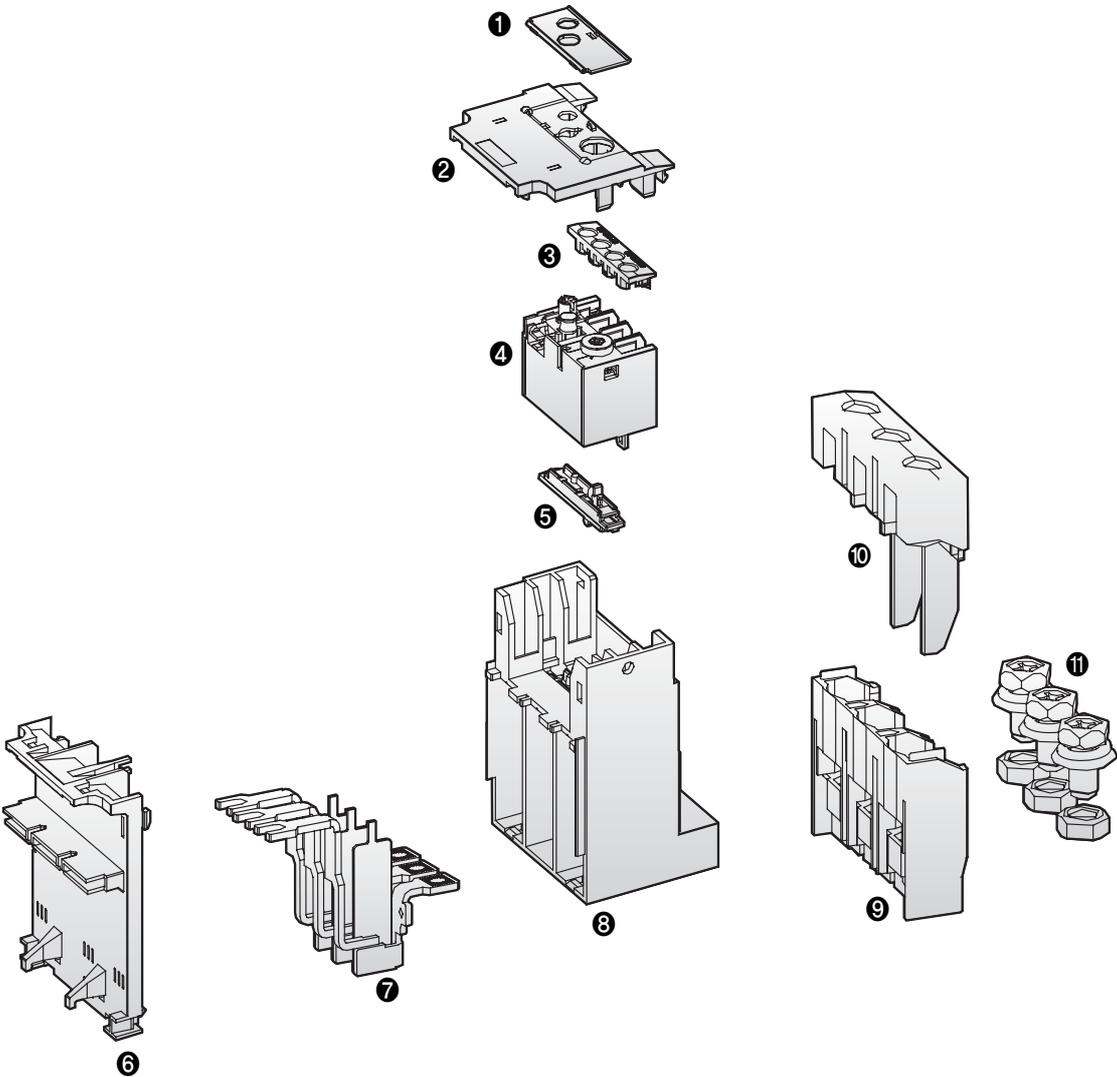

- ① Aux Top cover
- ② Top cover
- ③ Aux terminal cover
- ④ Aux case assembly
- ⑤ Shifter
- ⑥ Back cover
- ⑦ Heater assembly
- ⑧ Heater case
- ⑨ Screw case
- ⑩ Screw case cover
- ⑪ Screw assembly

Structure and Operation

2. Theory of Activation

2.2 Internal Structure

11) MT-150 Thermal overload relays(Screw)

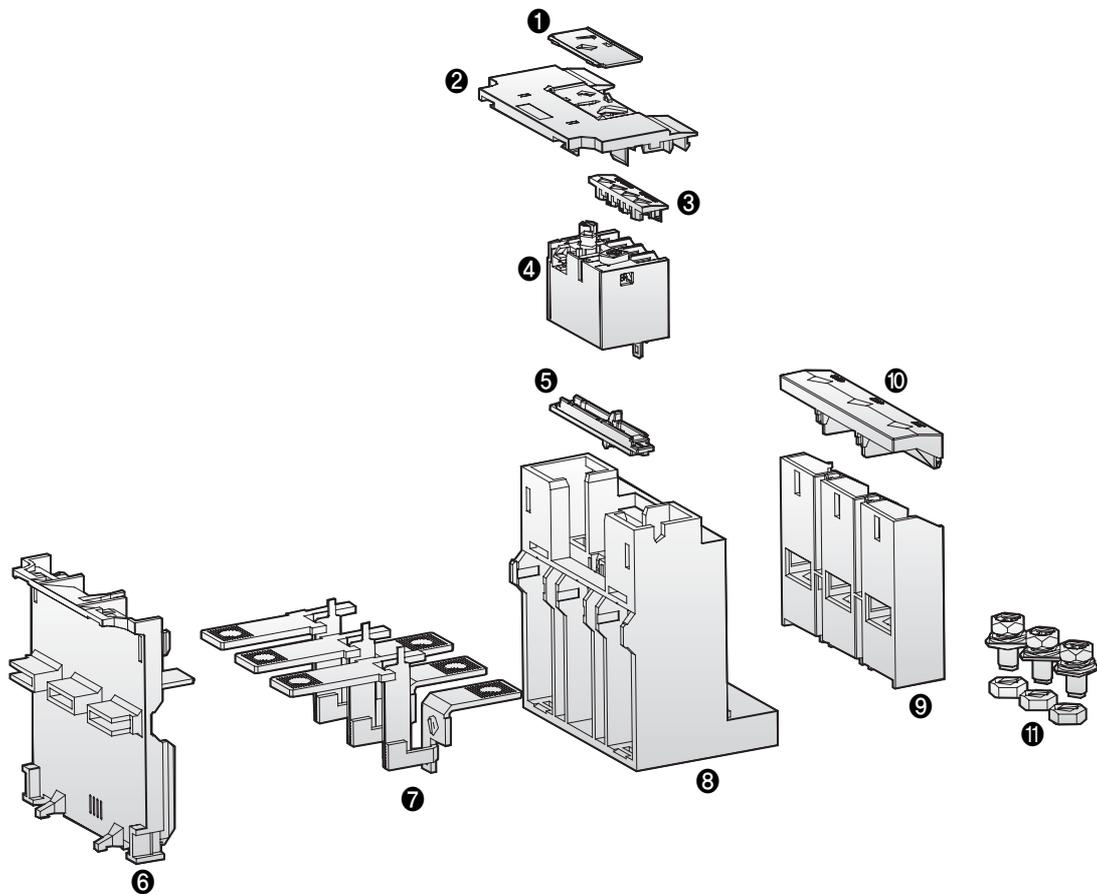

- ① Aux Top cover
- ② Top cover
- ③ Aux terminal cover
- ④ Aux case assembly

- ⑤ Shifter
- ⑥ Back cover
- ⑦ Heater assembly
- ⑧ Heater case

- ⑨ Screw case
- ⑩ Screw case cover
- ⑪ Screw assembly

B

12) MT-150 Thermal overload relays(Lug)

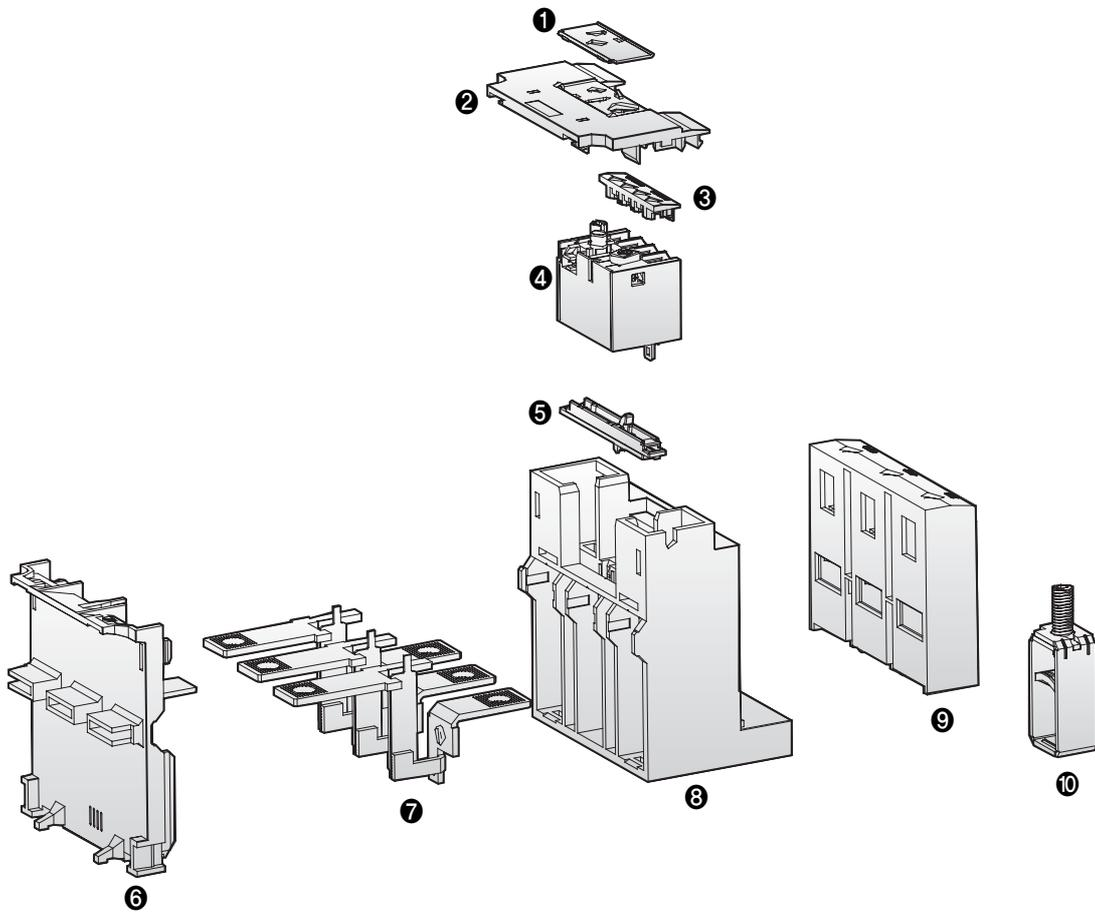

- ① Aux Top cover
- ② Top cover
- ③ Aux terminal cover
- ④ Aux case assembly

- ⑤ Shifter
- ⑥ Back cover
- ⑦ Heater assembly
- ⑧ Heater case

- ⑨ Lug case
- ⑩ Lug case cover

Structure and Operation

2. Theory of Activation

2.2 Internal Structure

13) MT-225 Thermal overload relays

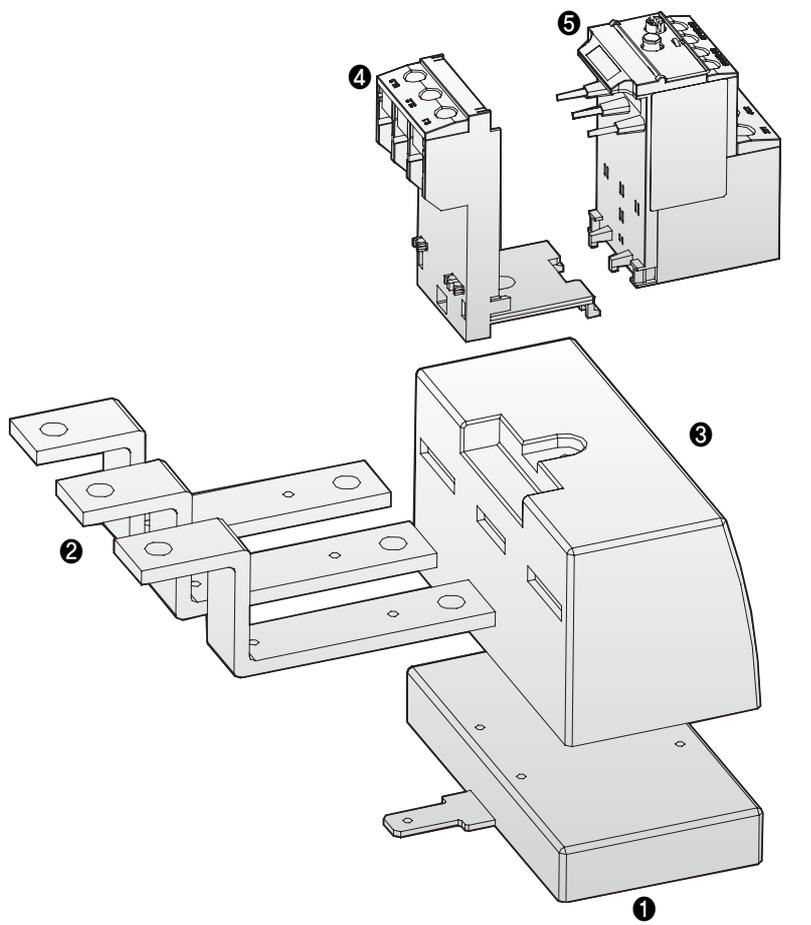

- ❶ Base plate
- ❷ Conductor
- ❸ C.T case assembly
- ❹ Mounting unit
- ❺ MT-225 sub assembly

14) MT-400 Thermal overload relays

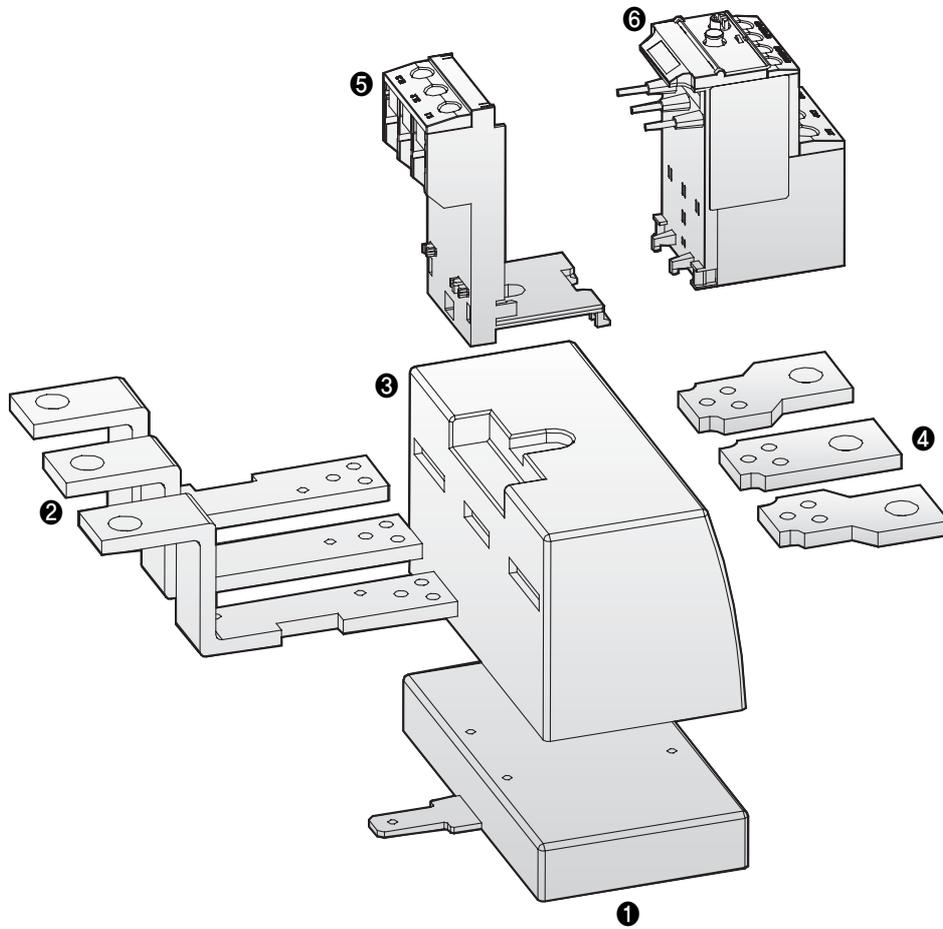

- ❶ Base plate
- ❷ Conductor
- ❸ C.T case assembly
- ❹ Terminal plate
- ❺ Mounting unit
- ❻ MT-400 sub assembly

Structure and Operation

2. Theory of Activation

2.2 Internal Structure

15) MT-800 Thermal overload relays

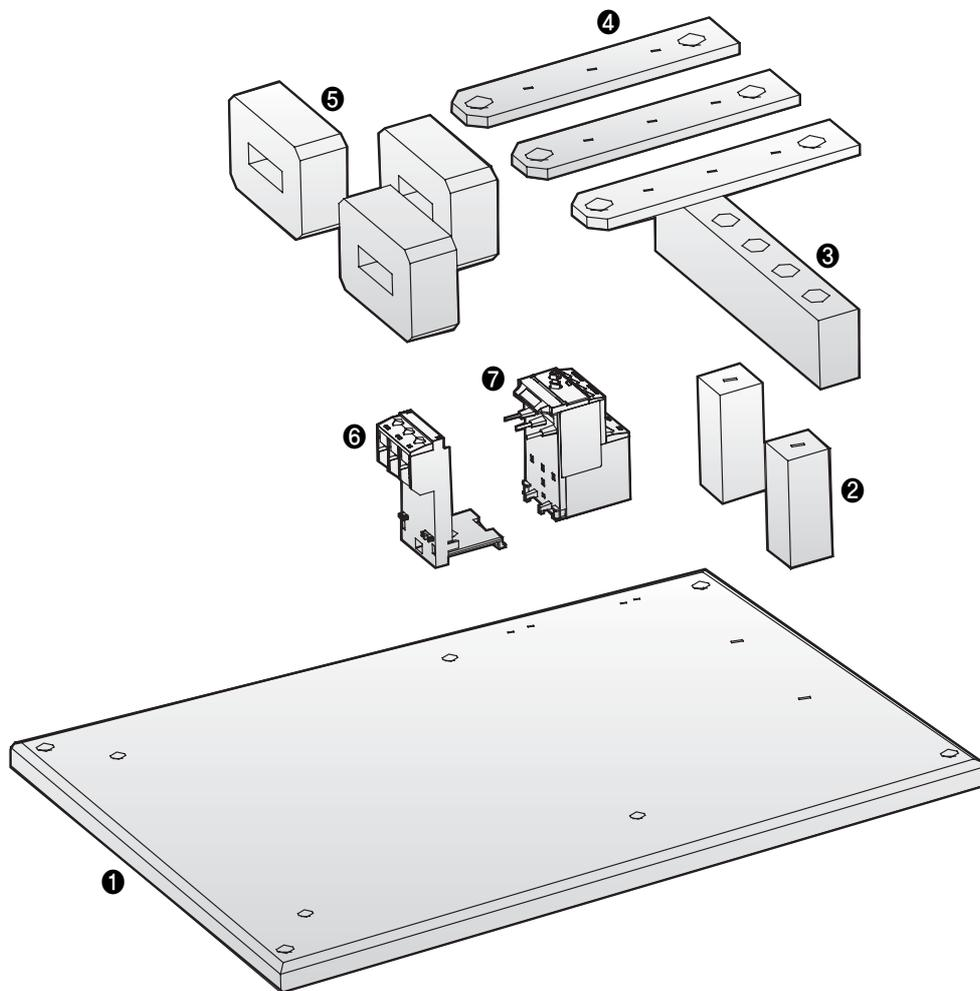

- | | |
|------------------------|-----------------------|
| ❶ plate | ❺ C.T |
| ❷ Base terminal B | ❻ Mounting unit |
| ❸ Base terminal A | ❼ MT-800 Sub assembly |
| ❹ Conductor connecting | |

2.3 Use of Magnetic Switch

1) Motor direct driving circuit

(1) Use : It is the most general and basic circuit to drive and stop a motor by using magnetic switch and push button switch. Driving, and stopping are controlled manually all the time. At this time the driving current runs at more than around six times of the rated current.

(2) Circuit diagram

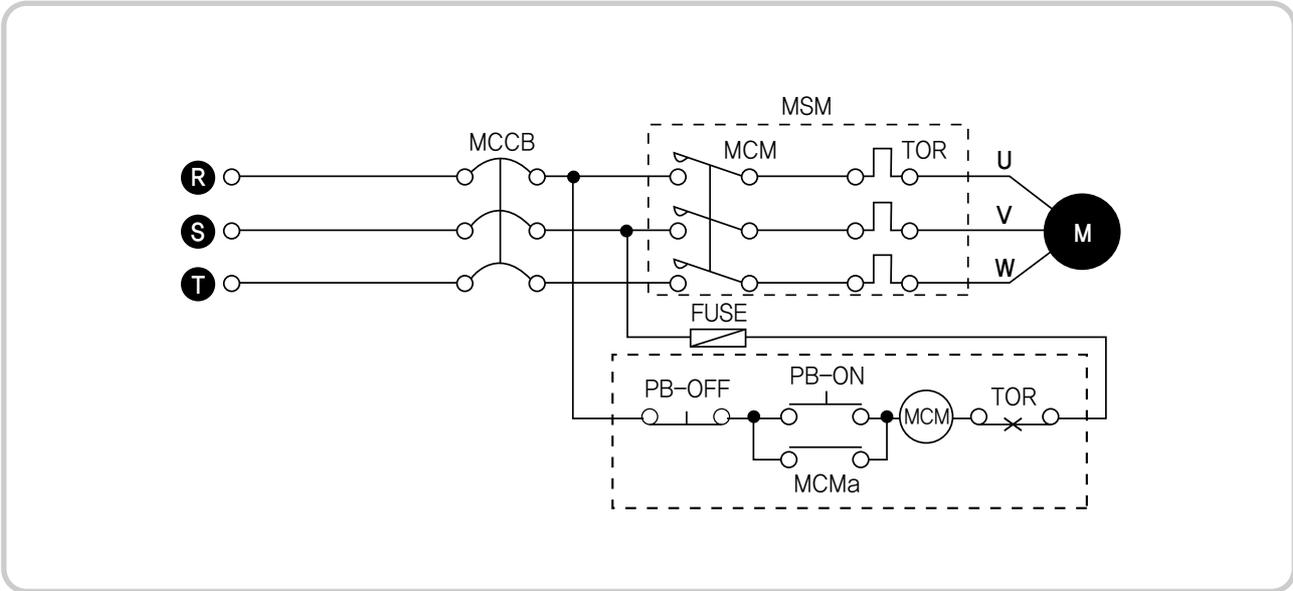

(3) Example of use

Section	Case 1	Case 2	Case 3
Order of operation	<ul style="list-style-type: none"> Operate On/Off from external signal Kinds of external signal ① Push button S/W ② Sub-relay, timer etc, sequence relay ③ Sequence output 	<ul style="list-style-type: none"> General magnetic maintenance circuit Sequence order ① PB-ON Push : The circuit is on, electromagnetic coil MCMa operates, the main contact point and sub-contact point(13-14) is closed. ② If MCMa magnetic maintenance circuit PB-ON is off, it flows current through the sub-contact point of the circuit. ③ PB-OFF Push Circuit is open, electromagnet is released, and sub-contact point(13-14) is open. ④ If MCM Off PB-OFF is closed because PB-ON and sub-contact point is being opened, it can still be off 	<ul style="list-style-type: none"> Combination of magnetic maintenance circuit and timer Sequence order ① PB-ON Push ② MCMa magnetic maintenance ③ MCM Off from the timer' time
Circuit diagram			

B

Structure and Operation

2. Theory of Activation

2.3 Use of Magnetic Switch

2) Reversing circuit

- (1) Use : Rotation/ counter-rotation of motor
- (2) Circuit diagram

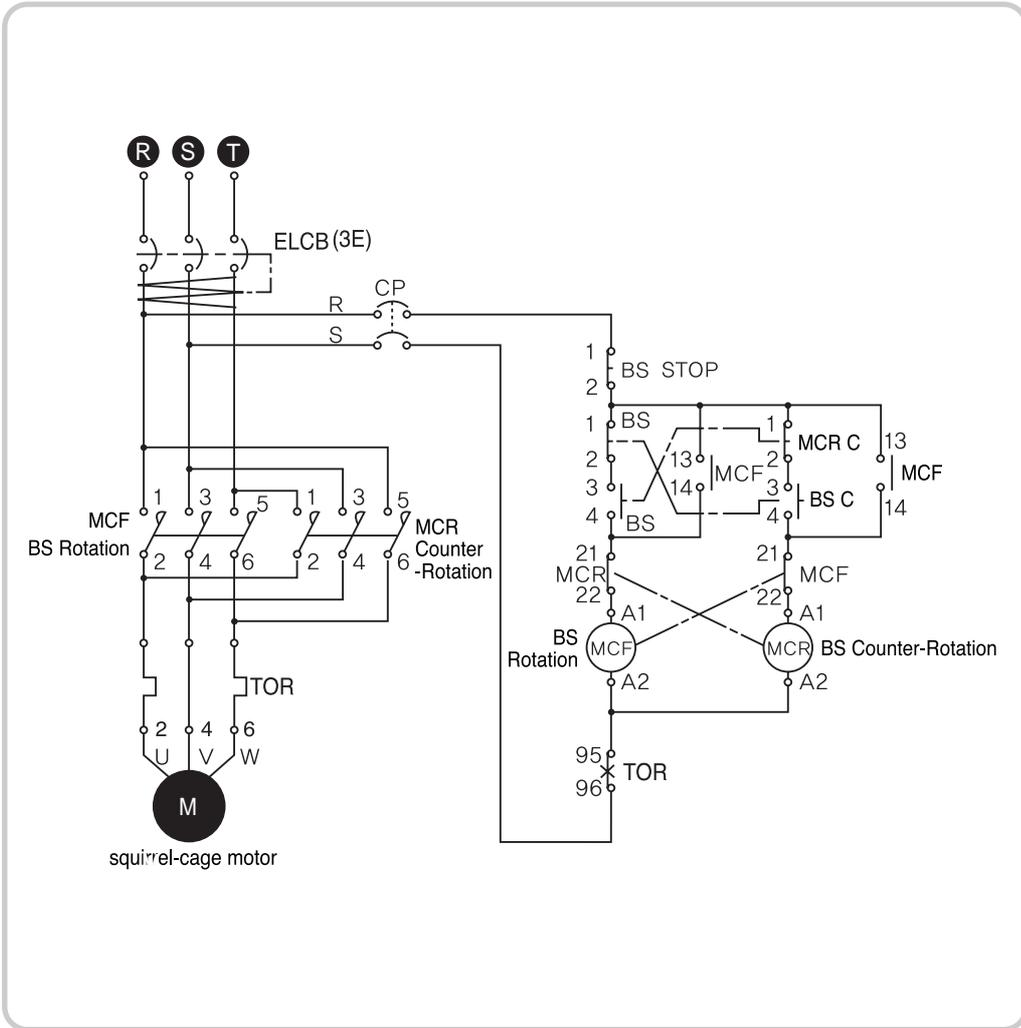

Mechanical interlocking use is recommended because interphase short circuit can occur due to mechanical activating difference when using an electrical interlock.

3) Star-delta circuit

- (1) Use : The driving current of the motor is one-third compared to direct drive type, upper phase transformer capacity can be less than direct drive also.
- (2) Circuit diagram

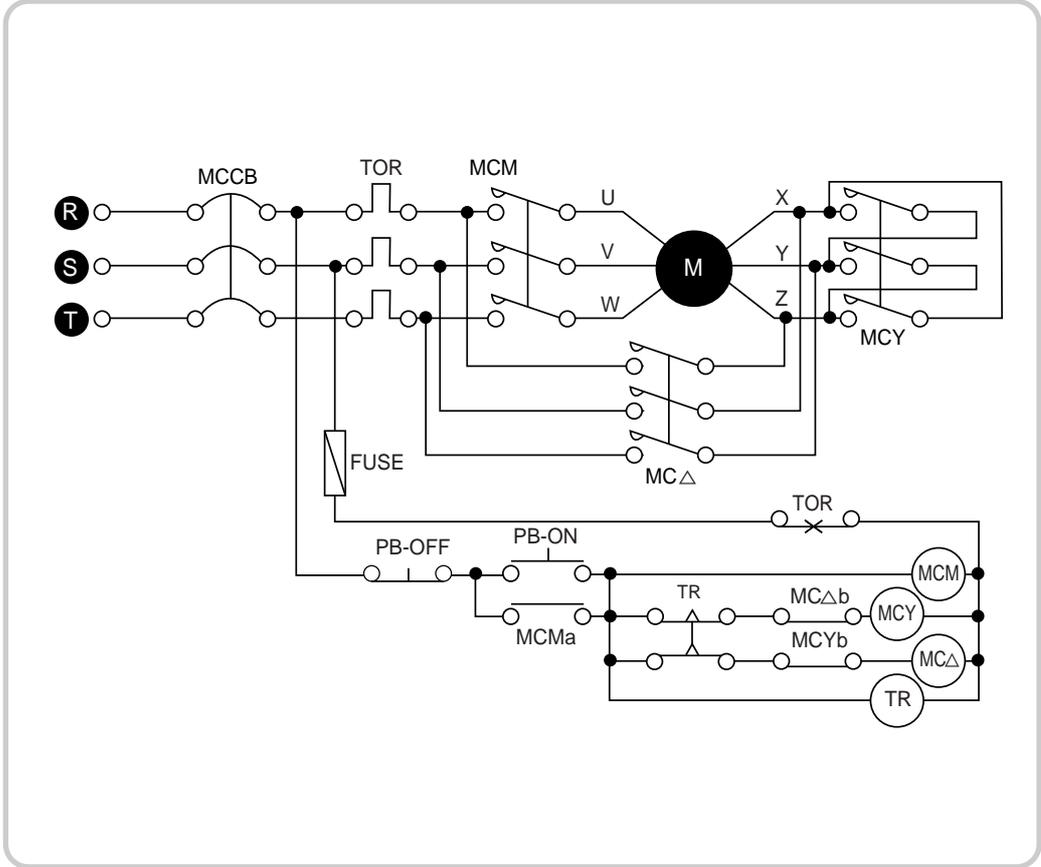

(3) Activation order

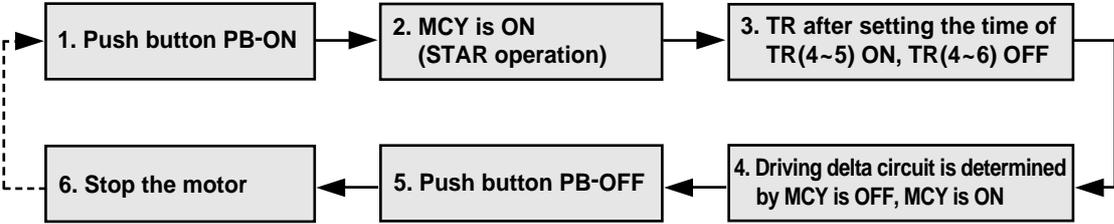

Structure and Operation

2. Theory of Activation

• MC Type

Magnetic Contactors



Frame size			
Type	screws clamp terminals		
Number of poles	3pole		
Rated operational voltage, Ue	690V		
Rated insulation voltage, Ui	690V		
Rated frequency	50/60Hz		
Rated impulse withstand voltage, Uimp	6kV		
Maximum operating rate in operating cycles per hour(AC3)	1800 operations per hour		
Mechanical	Mechanical		
Durability	Electrical		
Current	AC-1, Thermal current	A	
	AC-3 200/240V	kW	
	380/440V	kW	
	500/550V	kW	
	690V	kW	
	AC-4 200/240V	kW	
	380/440V	kW	
Size and weight	AC control Size (W×H×D)	Weight	kg
	DC control Size (W×H×D)	Weight	kg
Auxiliary(standard)	Side mount		
Auxiliary	Front mount		



Note) Minimum conduct current of Auxiliary contactor is DC 17V 5mA.

18AF			
MC-6a	MC-9a	MC-12a	MC-18a
●	●	●	●
3pole			
690V			
690V			
50/60Hz			
6kV			
1800 operations per hour			
15 mil. operations			
2.5 mil. operations			
25	25	25	32
2.5	2.5	3.5	4.5
9	11	13	18
3	4	5.5	7.5
7	9	12	18
3	4	7.5	7.5
6	7	12	13
4	6	9	9
1.5	1.5	2.2	3.7
7	8	11	16
2.2	2.2	4	4
5	6	9	11
0.25			
45×73.5×82			
0.47			
45×83×113.7			
1a or 1b			
UA-1			
AU-2, AU-4			

22AF			
MC-9b	MC-12b	MC-18b	MC-22b
●	●	●	●
3pole			
690V			
690V			
50/60Hz			
6kV			
1800 operations per hour			
15 mil. operations			
2.5 mil. operations			
25	25	32	40
2.5	3.5	4.5	5.5
11	13	18	22
4	5.5	7.5	11
9	12	18	22
4	7.5	7.5	15
7	12	13	20
4	7.5	7.5	15
6	9	9	18
1.5	2.2	3.7	3.7
8	11	16	18
2.2	4	4	5.5
6	9	11	13
0.25			
45×73.5×86			
0.47			
45×73.5×117.7			
1a1b			
UA-1			
AU-2, AU-4			

• MT Type

Thermal Overload Relays



Type	Screws clamp terminals		
Rated operational voltage, Ue	690V		
Rated insulation voltage, Ui	690V		
Rated impulse withstand voltage, Uimp	6kV		
Trip class	10A(Non-differential), 20(Class 20)		
Setting range	0.1~18A		
Size and weight	Weight	kg	
	Size(W×H×D)	mm	



* The safety cover of magnetic contactor and thermal overload relay is optional.

MT-12/□	
●	
690V	
690V	
6kV	
10A(Non-differential), 20(Class 20)	
0.1~18A	
0.17	
45×73.2×63.7	

MT-32/□	
●	
690V	
690V	
6kV	
10A(Non-differential), 20(Class 20)	
0.1~40A	
0.17	
45×75×90	

3. Table of Specifications



40AF	
MC-32a	MC-40a
●	●
3pole	
690V	
1000V	
50/60Hz	
8kV	
1800 operations per hour	
12 mil. operations	
2 mil. operations	
50	60
7.5	11
32	40
15	18.5
32	40
18.5	22
28	32
18.5	22
20	23
4.5	5.5
20	25
7.5	11
17	24
0.55	
69×83×93	
0.77	
69×83×120	
2a2b	
UA-1	
AU-2, AU-4	



65AF	
MC-50a	MC-65a
●	●
3pole	
690V	
1000V	
50/60Hz	
8kV	
1800 operations per hour	
12 mil. operations	
2 mil. operations	
70	100
15	11
55	40
22	18.5
50	40
30	22
43	32
30	22
28	23
7.5	5.5
35	25
15	11
32	24
1.05	
79×106×122	
1.3	
79×106×149	
2a2b	
UA-1	
AU-2, AU-4	



100AF		
MC-75a	MC-85a	MC-100a
●	●	●
3pole		
690V		
1000V		
50/60Hz		
8kV		
1800 operations per hour		
12 mil. operations		
2 mil. operations		
110	135	160
22	25	30
75	85	105
37	45	55
75	85	105
37	45	55
64	75	85
37	45	45
42	45	65
13	15	19
55	65	80
25	30	37
52	62	75
1.93		
94×140×137		
2.8		
94×140×174		
2a2b		
UA-1		
AU-2, AU-4		



MT-32/□
●
690V
690V
6kV
10A(Non-differential), 20(Class 20)
0.1~40A
0.17
45×75×90



MT-63/□
●
690V
690V
6kV
10A(Non-differential), 20(Class 20)
4~65A
0.31/0.33
55×81×100



MT-95/□
●
690V
690V
6kV
10A(Non-differential), 20(Class 20)
7~100A
0.48/0.5
70×97×110

B

Structure and Operation

3. Table of Specifications

• MC Type Magnetic Contactors



Frame size			
Type			
screws clamp terminals			
Number of poles			
Rated operational voltage, Ue			
Rated insulation voltage, Ui			
Rated frequency			
Rated impulse withstand voltage, Uimp			
Maximum operating rate in operating cycles per hour(AC3)			
Mechanical		Mechanica	
Durability		Electrical	
Current			
AC-1, Thermal current		A	
AC-3 200/240V		kW	
		A	
380/440V		kW	
		A	
500/550V		kW	
		A	
690V		kW	
		A	
AC-4 200/240V		kW	
		A	
380/440V		kW	
		A	
Size and weight			
AC control		Weight	
Size (W×H×D)		kg	
mm			
DC control		Weight	
Size (W×H×D)		kg	
mm			
Auxiliary(standard)			
Auxiliary		Side mount	
		Front mount	



150AF	
MC-130a	MC-150a
●	●
3pole	
690V	
1000V	
50/60Hz	
8kV	
1200 operations per hour	
5 mil. operations	
1 mil. operations	
160	210
37	45
130	150
60	75
120	150
60	75
90	100
55	55
60	60
93	120
45	55
90	110
2.1	
95×158×132	
2.1	
95×158×132	
UA-1	
AU-2, AU-4	

225AF	
MC-185a	MC-225a
●	●
3pole	
690V	
1000V	
50/60Hz	
8kV	
1200 operations per hour	
5 mil. operations	
1 mil. operations	
230	275
55	75
185	225
90	110
180	225
110	132
180	200
110	140
120	150
37	45
150	180
75	90
150	180
5.4	
138×203×181	
AU-100 (Max. 4NO4NC)	



Type			
Screws clamp terminals			
Rated operational voltage, Ue			
Rated insulation voltage, Ui			
Rated impulse withstand voltage, Uimp			
Trip class			
Setting range			
Size and weight		WeighWeight	
H		kg	
Size(W×H×D)		mm	



MT-150/□	
●	□
690V	
690V	
6kV	
10A, 20	
34~150A	
0.67	
95×109×113	

MT-225/□	
●	□
690V	
690V	
6kV	
10A, 20	
65~240A	
2.5	
147×141×183	

* The safety cover of magnetic contactor and thermal overload relay is optional.



400AF

MC-265a	MC-330a	MC-400a
●	●	●
3pole		
690V		
1000V		
50/60Hz		
8kV		
1200 operations per hour		
5 mil. operations		2.5 mil. operations
1 mil. operations		0.5 mil. operations
300	350	450
80	90	125
265	330	400
132	150	200
265	330	400
140	160	200
225	280	350
160	200	250
185	225	300
50	55	75
200	220	300
102	110	150
200	220	300

9.2
163×243×198



800AF

MC-500a	MC-630a	MC-800a
●	●	●
3pole		
690V		
1000V		
50/60Hz		
8kV		
1200 operations per hour		
2.5 mil. operations		0.5 mil. operations
580	660	900
147	190	220
500	630	800
250	300	400
500	630	800
250	300	400
400	500	720
300	400	500
380	420	630
90	110	160
350	400	630
176	200	300
350	400	630

22.4
285×312×242

AU-100(Max.4NO4NC)

AU-100(Max.4NO4NC)

• **MT Type Thermal Overload Relays**



MT-400/□

●
690V
690V
6kV
10A, 20
85~400A
2.6
151×171×198

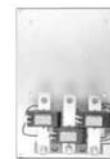

MT-800/□

●
690V
690V
6kV
10A, 20
200~800A
11.5
360×530×212



400AF

10A	20
MT-400/2H□	-
MT-400/3H□	-
MT-400/3K□	MT-400/3D□
Screw clamp	
3	
690V	
Up to 690V	
6kV	
IP 20	
-5~+40°C	
■	
■	
■	
■	

85~400AF

85~125
-
-
100~160
120~185
160~240
200~330
260~400
MC-265a, 330a, 400a
-

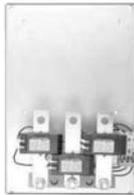

800AF

10A	20
MT-800/2H□	-
MT-800/3H□	-
MT-800/3K□	MT-800/3D□
Screw clamp	
3	
690V	
Up to 690V	
6kV	
IP 20	
-5~+40°C	
■	
■	
■	
■	

200~800AF

200~330
260~400
400~600
520~800
MC-500a, 630a, 800a
-

B

C. Operating Conditions

- 1. General Operational 53
Environment
- 2. Special Operational 55
Environment
- 3. RoHS Compliance 65

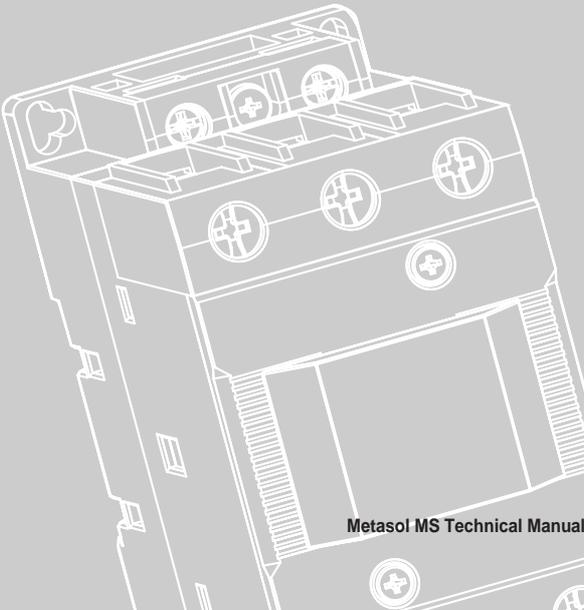

Operating Conditions

1. General Operational Environment



Apart from standard operational conditions if you use under circumstantial conditions it may cause a breakdown. You must consider general operational, as well as alternate solutions under special circumstances.

The magnetic switch has many operational options to be used in a wide range of circumstances, but it is based on and manufactured for the following standard operational conditions. Alternate solutions are required depending on the condition.

1.1 General Operational Environment

Standard operational conditions

- Ambient temperature: -5°C ~ 40°C
- Temperature inside the panel : standard 20°C , -10°C ~ 40°C (maximum 35°C average daily environmental temperature, maximum 25°C yearly average environmental)
Maximum temperature inside panel is AC3 grade 55°C . If AC4 grade rating standard is applied, maximum temperature is 65°C , and internal temperature/humidity should not cause condensation or freezing. (AC3 grade, AC4 grade rating refer to the standards described in the magnetic switch catalog) Because activating characteristics of magnetic contactor and TOR is changed by the surrounding temperature, be cautious.
- Relative humidity: 45~85%RH
- Altitude : less than 2,000m
- Vibration resistance: 10~55Hz 19.6m/s^2 (less than 2g)
- Shock resistance : 49m/s^2 (less than 5g)
- Environmental conditions : no dust, no smoke, no corrosive gas, no flammable gas, no moisture, not sealed (it may reach contact fault if used for a long time in a sealed environment)

Ambient temperature

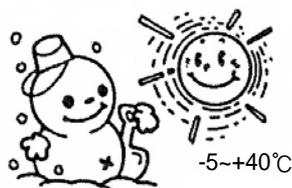

Relative humidity

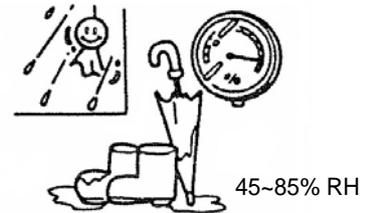

Altitude



Environmental conditions



■ **Applicable temperature range**

Product type \ Temperature	Operational temperature (°C)	Storage temperature (°C)
Enclosed product	-5°C ~ +55°C (AC Type) -5°C ~ +40°C (MT,DC Type) -25°C~ +60°C (MT refer to Graph)	-30°C ~ 65°C
Single product	-5°C ~ +55°C (AC Type) -5°C ~ +40°C (MT,DC Type) -25°C~ +60°C (MT refer to Graph)	-30°C ~ 65°C

Note 1) Storage temperature is surrounding temperature while shipping or storing, needs to be in the range of ambient temperature suitable with the initial condition of use.
 Note 2) No condensation, freezing conditions resulting from rapid temperature change.
 Note 3) Short period (less than 1000hours) storage permitted up to 80°C

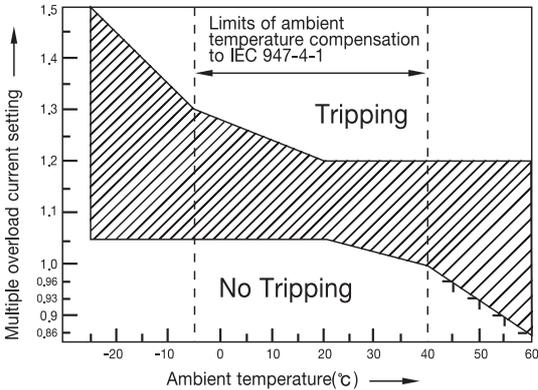

■ **Additional handling information**

- When the device operational is suspended for a long period of time, a heater must be used (0.5kW at 0.2 per Square decimeter of outer housing) heater should be automatically activated when the device is off. This heating will prevent condensation and water dropping, by maintaining the temperature inside the outer housing a little higher than the surrounding external temperature. Under normal operation heat is generated from the device itself and this heat is enough to provide this temperature difference.
- Operational for "standard use circumstances" pilot facility (product) can be extended to outdoor use depending on the assumption that, the assembly type consists of a zinc alloy, light alloy, or plastic material. In this case, it is essential to confirm whether the protection level of liquid or solid penetration is suitable for the application.

Operating Conditions

2. Special Operational Environment

2.1 Influence and Countermeasures Under Special Environment

Different operational conditions and their representative examples are appearing in the following table. To improve the resistance within an environment, because there is a limit, supplying outer parts (panel, case cover, etc.) should be structured with outdoor type, vibration resistance type, corrosion resistance type to prevent the fault.

Special environment	Applicable place	Magnetic switch influence	General countermeasures
Rapid temperature change (Climate)	<ul style="list-style-type: none"> ❖ Rapid temperature changing location (temperature difference between morning and evening) ❖ It is used as an exported product or passes through a tropical, high humidity place where temperature, atmospheric temperature relatively is high 	<ul style="list-style-type: none"> • Rust activation fault by condensation (freezing) 	<ul style="list-style-type: none"> • Decrease relative humidity by setting up a heater • Move it to the place where there is less temperature change • Re-inforce anti-corrosion treatment of the metal product to prevent rust by small quantities of moisture.
Low temperature	<ul style="list-style-type: none"> ❖ Refrigerator ❖ Low temperature storage ❖ Operational for passing through or being used in a cold environment 	<ul style="list-style-type: none"> • Freezing • Activation fault, rust by moisture (condensation) 	<ul style="list-style-type: none"> • Increase the temperature by setting up a heater • Dry
High temperature	<ul style="list-style-type: none"> ❖ Iron works ❖ Plastic mold plants 	<ul style="list-style-type: none"> • Mis-activation • Heat-resistance of connecting cable • Overheating of insulated material 	<ul style="list-style-type: none"> • Reduction of load current • Operational of heat resistant cable • Do not use in a place where inside the panel will be over 65°C
High humidity	<ul style="list-style-type: none"> ❖ Facility, Panel are for high humidity environmental operational <ul style="list-style-type: none"> • Farming greenhouse • Kitchen facility • Chemical plant • High temperature, high ❖ Humidity sealed environment <ul style="list-style-type: none"> • Car wash control unit • Explosion unit for mining ❖ Temperature, high humidity environment 	<ul style="list-style-type: none"> • Decrease insulating resistance • Corrosion, Rust • NH3 gas (in the plastic moulding process) and rust 	<ul style="list-style-type: none"> • Use with a waterproof panel (anti-corrosion treatment) • Frequent inspection • Ammonia free material is used for phenolic rosins, plastic moulded product
Corrosive gas, Salinity	<ul style="list-style-type: none"> ❖ Operational in environments with small quantities of hydrogen sulfide(H2S) <ul style="list-style-type: none"> • Oil refinery • Chemical plant • Coastal area • Water supply pump room (chlorine sterilizer) • Geothermal power plant 	<ul style="list-style-type: none"> • Decrease insulating resistance • Corrosion, rust 	<ul style="list-style-type: none"> • Use anti-corrosion treated product inside anti-corrosion type panel • Basically improve the structure of the panel
Dust and moisture	<ul style="list-style-type: none"> ❖ Gas environment of dust or corrosiveness <ul style="list-style-type: none"> • Cement plant • Cotton mill 	<ul style="list-style-type: none"> • Current flow fault of contact point • Activation fault of mechanical part • Insulation fire • Decreased insulation resistance 	<ul style="list-style-type: none"> • Vibration resistance, anti-corrosion type case cover is used

2.2 High Temperature

The temperature is usually determined by insulation durability (continuous current flow durability) of control coil and real-time change of plastic molded product when using with high surrounding temperature. The temperature rise of the control coil is stipulated with the standard including surrounding temperature, A type insulation at less than 125°C, E type insulation at less than 140°C, but MS is taking E type insulation for long-term use under 50°C inside the control panel and refraining from temperature rises less than A type. To estimate continuous flow current durability of the control coil, confirm whether there is a fault of damage and loss to the device by following continuous current flow acceleration tests at the control electromagnetic part.

- Thermostat temperature : 80°C
- Control coil permitted voltage : 110%(60Hz) of rated voltage
- Continuous flow current time: 5000hours
- Number of products for testing : 5 control electromagnets of each frame
- Test result: no damage or loss, no fault to surge layer test

Continuous flow current durability of control coil is usually determined by heating of coil material, according to Arrhenius' law, shown in figure six. From this result, the insulation durability of the control coil can be estimated from average surrounding temperature +coil temperature rise, generally has an estimated life span between 10 and 20 years.

To investigate real-time change of the plastic moulded product, an acceleration test is implemented over 96h by adding 65°C specified degrees of element temperature rise to surrounding temperature 40°C which totals 105°C but tested at 125°C to leave room for safety. If the main cause of elapsed year heating of part is temperature, the durability of the product τ calculated by Arrhenius' formula which is $\tau = A \cdot \exp(-Ea/kT)$ (A, Ea : Characteristic positive number per failure mode, T : absolute temperature, k : Boltzmann' constant). It is used for acceleration testing or estimating the life span of the product. Generally, as Arrhenius' Law stipulates that if temperature of operational circumstances are decreased by 10°C, durability is improved twofold, this is often used for calculating product durability.

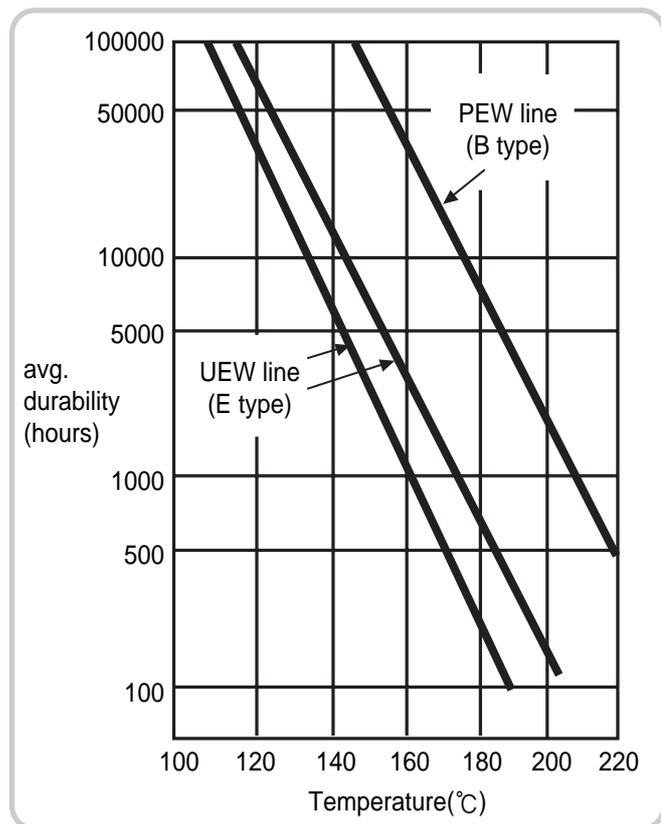

Fig. 6. Graph of coil wire heat-resistance durability

Operating Conditions

2. Special Operational Environment

2.2 High Temperature

Magnet switches and magnet contactores are assembled inside the panel and are shipped to cold areas or often used for extreme conditions such as operational inside of freezers. In this case the problem of cold resistance characteristics is used for standard storage, operational temperature is distinctly used as follows.

1. Storage temperature Over-55°C

No problem at each part, results from placing test within one month at -55°C. Therefore, it can resist enough over -55°C storage. There is usually waterproof, moisture proof packaging with the panel which is being sent to the cold area, but packed from a warmer area needs to have product damage considered due moisture, condensation, and freezing in the cold area. Therefore, we need to be concerned with dehumidification inside the packing, putting in three kilograms of silica gel per meter cubed inside the packaging is recommended.

2. Operational temperature over Over-25°C

Control implementation test was done in under -25°C conditions.

- Temperature : -25°C

There is no problem with the result, so it is possible for use at the low temperature range over -25°C.

Surrounding conditions			Standard product
Temperature	Operating	Without case cover	-5°C ~ +55°C (AC Type) ^{*1)} -5°C ~ +40°C (MT,DC Type)
		With case cover	-25°C ~ +60°C (MT refer to Graph)
	Shipping storage		-30°C ~ +65°C ^{*2)}
Relative humidity			less than 85% RH

Note 1) No condensation, freezing conditions by rapid temperature change

Note*1) TOR range up to -5°C

Note*2) TOR range up to -55°C

2.3 Temperature

Magnetic switch, magnetic contactor are not designed for high temperature, humidity conditions in principle. If used under such conditions, basically it is recommended to use by putting in assembled type of moistureproof structure considering the decrease in insulation capacity, electrical performance or durability decrease, and rust of metal products (especially the electromagnetic core). Therefore every kind of test is implemented considering the occurrence of abnormal environmental conditions. And also the test is being implemented with humid conditions from Lloyd' standard.

■ The treatment of high temperature, high humidity

This treatment is for setup within hot and humid environments with danger of condensation, water dropping, and rust. We apply the following treatment, plastic insulation part can prevent damage from white ants, cockroaches and other insects, but it doesn't mean this product has systematically high temperature and high humidity protection when it is set up in equatorial areas or other tropical areas. (Standards IEC 60947, NF C 26-220, DIN 5348)

- A metal assembly type is treated for anti-corrosion.

Protection treatment selection guide

Location	Environmental condition	Duty cycle	Internal heating of outer housing without use	Climate type	Protection treatment	
					component	Enclosure type
Indoor	no condensation or water dropping	not important	unnecessary	not important	standard use circumstances	standard use circumstances
	condensation or water dropping	frequent switching on and off for over one day	none	temperate region	standard use circumstances	high temperature, high humidity
				temperate region	high temperature, high humidity	high temperature, high humidity
		exists	not important	standard use circumstances	high temperature, high humidity	
	continuous	unnecessary	not important	standard use circumstances	high temperature, high humidity	
Outdoor (protected)	no water dropping or condensation	not important	unnecessary	temperate region	standard use circumstances	high temperature, high humidity
				equatorial region	standard use circumstances	high temperature, high humidity
Outdoor, exposed or near the sea	frequent condensation and water dropping	frequent switching on and off for over one day	anone	temperate region	standard use circumstances	high temperature, high humidity
				equatorial region	standard use circumstances	high temperature, high humidity
				exists	not important	standard use circumstances
		continuous	unnecessary	not important	standard use circumstances	high temperature, high humidity

Switching test under high temperature, high humidity conditions

1. Testing methods and types

Magnetic contactor switch is recommended to be used under standard operational conditions, in the rare case it is difficult to maintain this. Therefore we are testing under the following conditions.

1) Test of temperature and humidity
In fig. 7. after testing under temperature and humidity conditions, if there is no problem with pulsation from corrosion, aging insulating material, change of plastic moulded product, and performance change then the result is satisfactory.

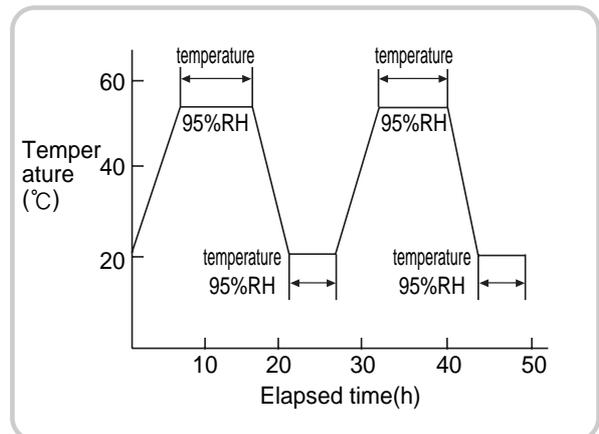

Fig. 7. Testing conditions of temperature and humidity

2) Salt water spraying test

Salt water spraying test is often implemented for evaluating in consideration of the environment of the magnetic contactor. Test specifications are satisfied before and after the salt water spraying test by testing under the following conditions

Water	Salt	Temperature	35°C PH	35°C Concentration	Salt water amount of 85cm ² at 1h	Spraying time	Cleaning method of test product
distilled water	refined salt	35°C	7.0	5%	1.3cc	48h	clean with water

Operating Conditions

2. Special Operational Environment

2.4 Protection Under Special Environment

■ Dust

Magnetic switch contactor cement factory, cotton factory, construction site etc. in case of places where there are high levels of dust, control unit vibration and resistance structure or assembly type structure should be a vibration-resistant structure. When the dust is attached to the contact point, contact resistance is increased, abnormal temperatures at the contact point increase and it causes increased aging of the insulation material or degradation of the electrical on/off durability. Aside from that, the dust attached to the insulation material degrades the insulation characteristics/ability and increases the likelihood of an electrical short. Also, when the dust settles between an electromagnetic armature, because of imperfect electromagnetic absorption, it causes pulsation noises.

■ Gas

1. When magnetic contactor is used for chemical factory, refinery, sewage disposal plant etc where there is much corrosive gas, basically it is recommended to consider the protective structure of the panel. About small quantities of corrosive gas, it is possible to protect by coating the weak points making them strong against corrosive gas but because there is no perfect way for a silver series contact point which is used for contact point material, there is a limit in protecting a single product. Therefore a small quantity of corrosive gas in this kind of atmosphere please select a magnetic contactor which can be used in this kind of atmosphere.

2. Because the velocity of metal corrosion under an atmosphere containing corrosive gas is delayed as humidity and temperature decrease, it is a good idea to blow in clean air into the panel with increasing internal pressure by using an air conditioner. The figure shows matter/humidity/temperature and tendency of corrosion process velocity.

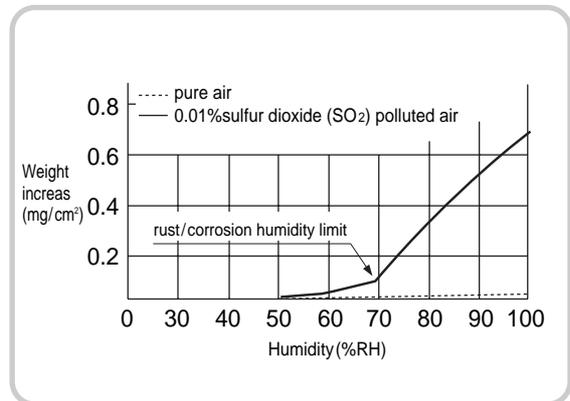

Fig. 8. The amount of corrosion change due to humidity.

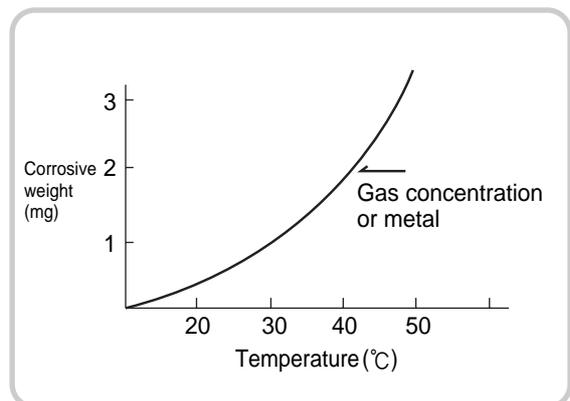

Fig. 9. The amount change in corrosion by temperature

2.5 Corrosive Gas

1) Corrosive gas application circumstances example in the atmosphere

Gas Conditions	Concentration(ppm)		Example of application environment	Influence upon metal type and conditions
	Normal	Abnormal		
Hydrogen sulphide(H₂S)	Less than 0.02	Over 0.07	<ul style="list-style-type: none"> Hot springs area Near a steel plant Sewage treatment Paper plant 	<ul style="list-style-type: none"> Silver(Ag) : tarnishing Bronze(Cu) : tarnishing, corrosive
Sulfur dioxide(SO₂)	Less than 0.04	Over 0.07	<ul style="list-style-type: none"> Near a steel plant Chemical plant 	<ul style="list-style-type: none"> Nickel(Ni) : tarnishing Iron(Fe) : turning red and blue, corrosive Zinc(Zn) : turning white and blue, corrosive Bronze(Cu) : tarnishing ※ Corrosion is strongly reduced when humidity is less than 65%
Cholorine gas(Cl₂)	Less than 0.02	Over 0.05	<ul style="list-style-type: none"> Water supply Chemical plant Pool sterilization room 	<ul style="list-style-type: none"> Tin(Sn) : tarnishing, corrosion Chrome(Cr) : tarnishing, corrosion
Nitrogen dioxide(NO₂)	Less than 0.04	Over 0.5	<ul style="list-style-type: none"> Urban district Chemical plant 	<ul style="list-style-type: none"> Iron(Fe) : turning red and blue, corrosion Zinc(Zn) : turning white and blue, corrosion ※ Corrosion is strongly reduced when humidity is less than 65%
Ammonia(NH₃)	Less than 0.01	Over 5	<ul style="list-style-type: none"> Chemical plant 	<ul style="list-style-type: none"> Brass : stress corrosion, cracking

2) Corrosive gas and metal anti-corrosion influence table

Material \ Gas	Hydrogen sulfide (H ₂ S)	Sulfur dioxide (SO ₂)	Chlorine gas (Cl ₂)	Nitrogen dioxide (NO ₂)	Ammonia (NH ₃)
Silver(Ag)	×	△	△	△	○
Bronze(Cu)	×	△	×	△	○
Nickel(Ni)	△	×	×	△	○
Chrome(Cr)	△	△	△	△	○
Tin(Sn)	○	○	○	○	○
Stainless teel(SUS304)	◎	○	×	◎	◎
Brass(C2680)	×	△	×	△	×
Nickel alloy(CuNi)	△	○	×	×	○

※ Legend : ◎Superior, ○Good, △Normal, ×Bad

Operating Conditions

2. Special Operational Environment

2.6 High Altitude Application

In cases when the air break switch of the magnetic switch is installed at a high altitude, air density, insulation ability and cooling coefficients decrease by the follow standards and need to be properly compensated for.

High-altitude application standards

In case of high altitude installation, the rated level of insulation voltage and current flow the magnetic switch is reduced as dictated by ANSI standard, the BS standard or IEC standard and are shown in table 1.

Table 1. Rated compensation coefficient at altitudes of more than 1000m

Type	ANSI C37 30-1971			BS2692 PT1-1971/IEC Pub.282-1-1985			
	Rated insulation voltage	Rated current flow of current	Surrounding temperature	Voltage resistance test voltage	Rated insulation voltage	Rated current flow current	Temperature rise
1000	1.00	1.00	1.00	1.0	1.0	1.0	1.0
1200	0.98	0.995	0.992	↑ proportional	↑ proportional	↑ proportional	↑ proportional
1500	0.95	0.99	0.980	1.05	0.95	0.99	0.98
1800	0.92	0.985	0.968	↑ proportional	↑ proportional	↑ proportional	↑ proportional
2100	0.89	0.98	0.956				
2400	0.86	0.97	0.944				
2700	0.83	0.965	0.932				
3000	0.80	0.96	0.920				
3600	0.75	0.95	0.896	1.25	0.80	0.96	0.92
4200	0.70	0.935	0.872	↓ proportional	↓ proportional	↓ proportional	↓ proportional
4800	0.65	0.925	0.848				
5400	0.61	0.91	0.824				
6000	0.56	0.90	0.800				

Note 1) Magnetic switch' s normal operational condition at altitudes of 2000m and when it is more than 2000m rated compensation is done with the standards of this table.

Note 2) Either rated control current or surrounding temperature needs to be reduced (usually they are not both reduced).

Surrounding temperature decrease prevention

Because surrounding temperature decreases generally, the specified products of the site are applied by the demand.

2.7 Oil Mist

In case of tooling machine control board, cutting tool oil becomes oil mist, it usually attaches to the contact point of the magnetic contactor and switch inside the panel. Under these circumstances, there is no possibility of danger that the contact point will cause a contact fault, but when the oil is dissolved by the switch arc, it emits much hydrogen gas and accelerates consumption of oil on the contact point. When this happens, it increases consumption of oil on the contact point tens of times faster than without oil. So, in these circumstances, we need to have a protective structure to prevent oil mist penetration inside the panel.

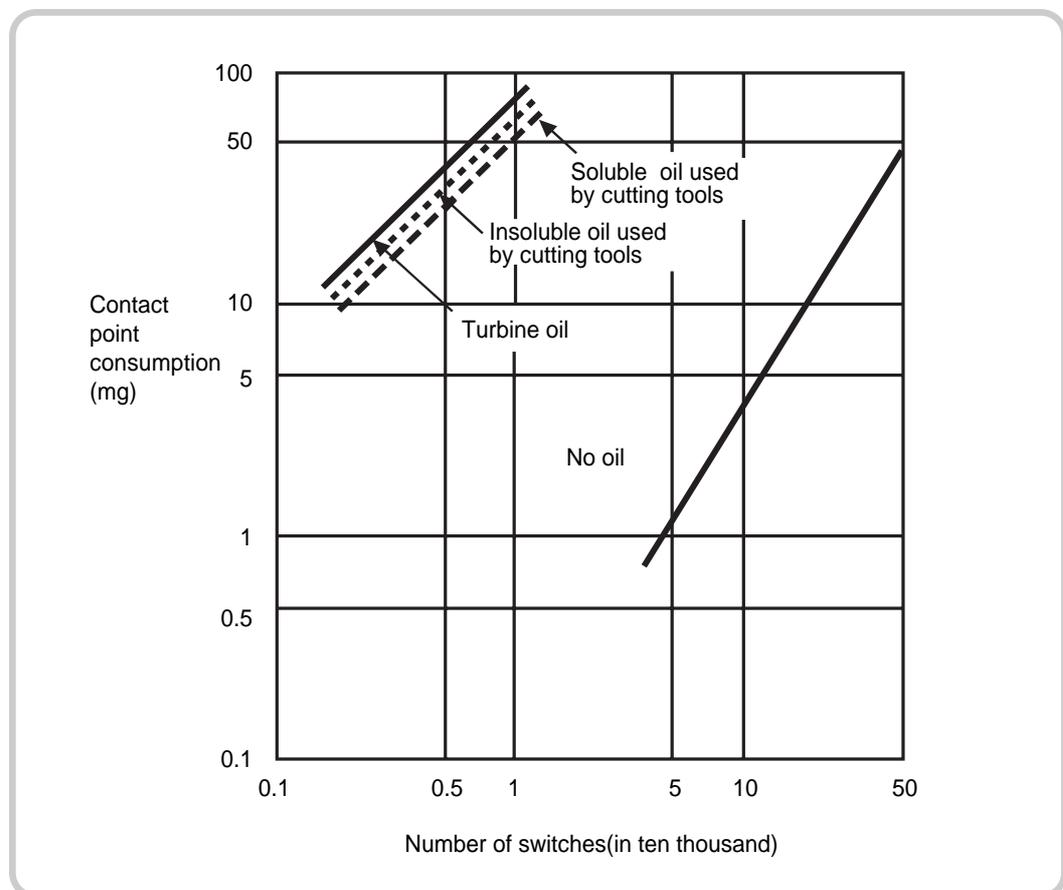

Fig. 10. Comparison with and without oil attached at the contact point

1. Public standard product : MC-9a

- (a) product without oil
- (b) product with oil
 - Spread oil 1.5ml at every contact point before the start of the test or 1000 on/off switches

2. Test conditions

- 3phase 200V 3.7Kw
- AC 3level load
- 1200 numbers/hours

3. Contact point consumption

- 3 phase total consumption

Operating Conditions

2. Special Operational Environment

2.8 Degree of Live Part Protection from Human Access, Solid Material and Water Penetration

The European standard EN 60529 dated October 1991, IEC publication 529 (2nd edition - November 1989), defines a coding system (IP code) for indicating the degree of protection provided by electrical equipment enclosures against accidental direct contact with live parts and against the ingress of solid foreign objects or water. This standard does not apply to protection against the risk of explosion or conditions such as humidity, corrosive gasses, fungi or vermin.

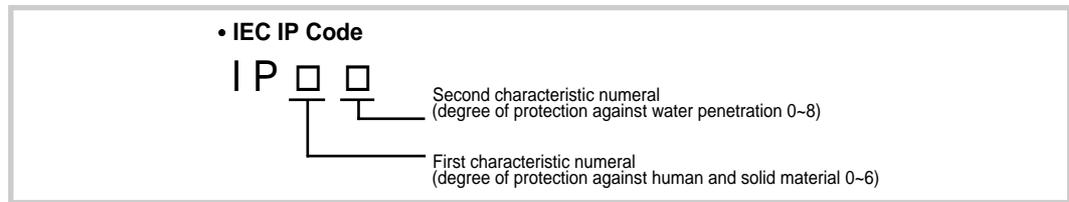

1. IP code

IP(International Protection) is a two-digit code regulating protection against foreign substances and water penetration for electrical equipment enclosures following the IEC standard.

Protection degree	1nd Characteristic numeral			Protection degree	2nd Characteristic numeral		
	Protection of the equipment		Human protection		Harmful effect of water		Waterproofing method
	Example	Requirements			Example	Requirements	
0		Non-protected	Non-Protected	0		Non-protected	Non-Protected
1		Protected against the penetration of solid objects having a diameter greater than or equal to 50mm	Protected against direct contact with the back of the hand (accidental contacts).	1		Protected against dripping water (condensation)	Vertical dropping
2		Protected against the penetration of solid objects having a diameter greater than or equal to 12.5mm	Protected against the penetration of solid objects having a diameter greater than or equal to 12.5mm	2		Protected against dripping water at an angle of 15deg.	dropping at an angle of 15deg.
				3		Protected against dripping water at an angle of 60deg.	limited spray
3		Protected against the penetration of solid objects having a diameter greater than or equal to 2.5mm	Protected against direct contact with a Ø2.5mm tool	4		Protected against splashing water in all directions.	spray from all directions
4		Protected against the penetration of solid objects having a diameter greater than or equal to 1mm	1 Protected against direct contact with a Ø1mm wire	5		Protected against jets of water in all directions.	Jets from all directions
5		Dust protected (no harmful deposits)	Protected against direct contact with a Ø1mm wire	6		Protected against powerful jets of water and waves.	Strong jets from all directions
6		Dust tight	Protected against direct contact with a Ø1mm wire	7		Protected against the effects of temporary immersion	temporary immersion
				8		Protected against the effects of prolonged immersion under specified conditions	continuous immersion

2. Additional letter

Corresponds to protection of humans against direct contact with live parts.

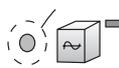
Degree of protection		Additional letter (selection)		Prevention method against approaching dangerous equipment
		Example	Requirements	
A	Used together with first number 0	Ø 50mm 	Objects with a diameter of 50mm or greater cannot contact the dangerous equipment	Back of hand
B	Used together with first number 0,1	Ø 12.5mm 	Test finger penetration objects with a diameter of as small as 80mm cannot contact the dangerous equipment	Finger
C	Used together with first number 1,2	Ø 2.5mm 	With wire 2.5mm diameter x 10mm long if spherical surface stop face goes in partially, it cannot contact dangerous equipment	Tool
D	Used together with first number 2,3	Ø 1mm 	With wire 1.0mm diameter x 100mm long if spherical surface stop face goes in partially, it cannot contact dangerous equipment	Wire

2.9 Degrees of Protection Against Mechanical Impact

The European standard EN 50102 dated March 1995 defines a coding system (IK code) for indicating the degree of protection provided by electrical equipment enclosures against external mechanical impact. Standard NFC 15-100 (May 1991 edition), section 512, table 51 A, provides a cross-reference between the various degrees of protection and the environmental conditions classification, relating to the selection of equipment according to external factors. Practical guide UTE C 15-103 shows, in the form of tables, the characteristics required for electrical equipment (including minimum degrees of protection), according to the locations in which they are installed.

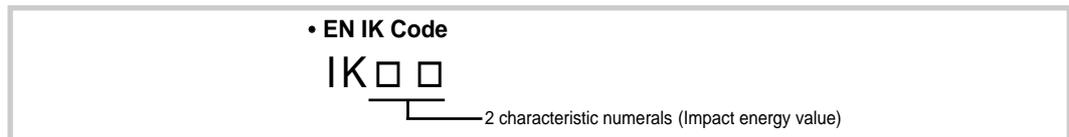

1. IK code

IK is a two-digit code regulating protection against mechanical impact from outside following the EN standard.

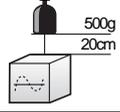
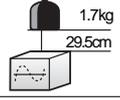
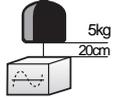
Type	Example	h(cm)	Energy(J)
00	Non-protected		
01		7.5	0.15
02		10	0.2
03		17.5	0.35
04		25	0.5
05		35	0.7
06		20	1
07		40	2
08		30	5
09		20	10
10		40	20

Operating Conditions

3. RoHS Compliance

Natural environmental pollution destruction has become a worldwide social issue. The solution of environment problems in the modern global world is more importantly recognized, the main environmental problems are waste material problems, automotive pollution problems, global warming, chemical materials etc. In our country the environmental directive is in the process of becoming law, the core content has fundamental environment law, material circulation economy society formation fundamental law, green purchasing law, recyclable container packaging law, recyclable appliances law. The European Union is establishing the system to distinguish and return general waste materials and electronic device waste materials, electronic device sales after 2006/7/1 are limited for hazardous material use and minimizing the impact to the environment and human health, WEEE(waste electrical and electronic equipment) or RoHS(The Restriction of the use of certain Hazardous Substances in Electrical and Electronic Equipment) is established. In order to serve our corporate duty/role, LSIS puts a priority on quality, environment, safety, and establishing environmental directives based on following environmental law, by currently running an environmental management program for sound practices, we are following our plan for constantly possible administration. LSIS in 2005 has declared "green purchase law" and stipulated prohibition of use of 6 hazardous materials with our collaborating partners, additionally in 2006/4 we declared RoHS compliance, we are following environment friendly management activity by constructing RoHS directive manufacturing system.

■ **RoHS** | The Restriction of the use of certain Hazardous Substances in Electrical and Electronic Equipment

■ **RoHS directive** | This is established in EU, six hazardous materials inside our product correspond to it, it is limited to a single material standard, not to be exceeded by the specified amount. Regardless of intentional addition, limit amount is as below with homogeneous material standard.

Hazardous material	RoHS standard level(ppm)
Cadmium(Cd)	Less than 100
Mercury (Hg)	Less than 1000
Plumbum (Pb)	Less than 1000
Hexavalent chromium(Cr+6)	Less than 1000
Polybrominated biphenyl (PBB)	Less than 1000
Polybrominated diphenyl Ether (PBDE)	Less than 1000

■ **RoHS range**

The target products of the RoHS directive have become series 1~7, series 10, and medical devices system(series 8), supervising or control unit (series 9) is exempted from this target. Also, it is not applied to electrical maintenance spare parts for electrical devices, reused products, which were sold before 2006/ 7/ 1.
The series below is applied to electrical devices which are under rated voltage which doesn't exceed AC 1000V, DC 1500V.

Per series or product class		Details of targeted product class
Series 1	Large size appliances	Refridgerator, freezer, washing machine, oven, air conditioner, dishwasher, microwave, ceiling fan, air conditioner, ventilation fan etc.
Series 2	Small size appliances	Washing machine, iron, toaster, electric razor, coffee maker, clock, scale etc
Series 3	IT and communication devices	Computer, printer, photocopier, fax machine, telephone, mobile phone, other sound, image, information etc. or other data transfer devices
Series 4	Consumption appliances	TV, radio, video camera, VCR, stereo etc.
Series 5	Lighting devices	Household electrical lighting/decorative lighting, fluorescent, natrium, neon signs(except for filament light)
Series 6	Electric and electronic tools	Drill, saw, sewing machine, lathes, welding machines, cutting equipment etc.(Except for large size industrial fixed equipment)
Series 7	Toy and leisure equipment	Train or car race set, video games, treadmill, slot machine
Series 8	Medical devices	Radiation medical devices, Electrocardiogram(ECG)measuring device, dialysis machine, respirator, analysis device, etc (except for bio transplant device or pollution measuring device)
Series 9	Examination and control devices	Gas detector, thermostat, measuring/controlling experimental equipment etc.
Series 10	Vending machines	Cold drink vending machine, ATM, other vending machines

Our product does not correspond to the upper product classes, but it can correspond indirectly when it is installed inside the upper product classes, we are producing environmentally friendly products without hazardous materials to lead environmental conservation by practicing environmentally friendly management activities, furthermore actively participating in earth environment conservation.

Operating Conditions

3. RoHS Compliance

■ RoHS exception

The listed below approve of RoHS exception.
(Currently revision of EU-additional reviewing)

Mercury (Hg)	<ol style="list-style-type: none"> Mercury in compact fluorescent lamps, not exceeding sphere of 5mg per lamp. Mercury in straight fluorescent lamps for general purposes not exceeding: <ul style="list-style-type: none"> - halophosphate 10mg - triphosphate with normal lifetime 5mg - triphosphate with long lifetime 8mg Mercury in straight fluorescent lamps for special purposes. Mercury in other lamps not specifically mentioned in this Annex(Directive 2002/95/EC).
Lead (Pb)	<ol style="list-style-type: none"> Lead in glass of cathode ray tubes , electronic components and fluorescent tubes. Lead as an alloying element in steel containing up to 0.35% lead by weight, aluminium containing up to 0.4% lead by weight, and as a copper alloy containing up to 4wt% lead by weight. - Lead in high melting temperature solder (i.e.lead-based alloys containing 85% by weight or more lead)(*1), <ul style="list-style-type: none"> - Lead in solders for servers, storage and storage array systems, network infrastructure equipment for switching, signalling, transmission as well as network management for telecommunications(*1), - Lead in electronic ceramic parts (e.g. piezo electronic devices), - Lead in solders consisting of more than two elements for the connection between the pins and the package of microprocessors with a lead content more than 80% and less than 85% by weight(*2), - Lead in solders to complete a viable electrical connection between semiconductor die and carrier within integrated circuit Flip Chip packages(*2). Lead used in compliant pin connector systems(*2). Lead as a coating material for the thermal conduction module c-ring(*2). Lead and cadmium in optical and Filter glass(*2). Lead in Lead-bronze bearing shells and bushes(*3). Lead in linear incandescent lamps with silicate coated tubes(*4). Lead halide as radiant agent in High Intensity Discharge (HID) lamps used for professional reprography applications(*4). Lead as activator in fluorescent powder (1% lead by weight or less) of discharge lamps when used as sun tanning lamps containing phosphors such as BSP (BaSi2O5:Pb) as well as when used as speciality lamps for diazo-printing reprography, lithography, insect traps, photochemical and curing processes containing phosphors such as SMS (Sr,Ba)2MgSi2O7:Pb(*4). Lead with PbBiSn-Hg and PbInSn-Hg in specific compositions as main amalgam and with PbSn-Hg as auxiliary amalgam in very compact Energy Saving Lamps (ESL)(*4). Lead oxide in glass used for bonding front and rear substrates of flat fluorescent lamps used for Liquid Crystal Displays (LCD)(*4). Lead in printing inks for the application of enamels on borosilicate glass(*5). Lead as impurity in RIG (rare earth iron garnet) Faraday rotators used for fibre optic communications systems(*5). Lead in finishes of fine pitch components other than connectors with a pitch of 0.65 mm or less with NiFe lead frames and lead in finishes of fine pitch components other than connectors with a pitch of 0.65 mm or less with copper lead-frames(*5). Lead in solders for the soldering to machined through hole discoidal and planar array ceramic multilayer capacitors(*5). Lead oxide in plasma display panels (PDP) and surface conduction electron emitter displays (SED) used in structural elements; notably in the front and rear glass dielectric layer, the bus electrode, the black stripe, the address electrode, the barrier ribs, the seal frit and frit ring as well as in print pastes(*5). Lead oxide in the glass envelope of Black Light Blue (BLB) lamps(*5). Lead alloys as solder for transducers used in high-powered (designated to operate for several hours at acoustic power levels of 125 dB SPL and above) loudspeakers(*5). Lead bound in crystal glass as defined in Annex I (Categories 1,2,3 and 4) of Council Directive 69/493/EEC(*5).
Cadmium (Cd)	<ol style="list-style-type: none"> Cadmium and its compounds in electrical contacts and cadmium plating except for applications banned under Directive 91/338/ECC amending Directive 76/769/EEC relating to restrictions on the marketing and use of certain dangerous substances and preparations(*1). Lead and cadmium in optical and Filter glass(*2). Cadmium in printing inks for the application of enamels on borosilicate glass(*5)
Hexavalent (PBB)	<ol style="list-style-type: none"> Hexavalent chromium used for corrosion prevention in absorption-type refrigerator carbon steel cooling systems. Hexavalent chromium in corrosion preventive coatings of unpainted metal sheetings and fasteners used for corrosion protection and Electromagnetic Interference Shielding in equipment falling under category three of Directive 2002/96/EC (IT and telecommunications equipment). Exemption granted until 1 July 2007(*5).
Chromium (PBDE)	<ol style="list-style-type: none"> DecaBDE in polymeric applications(*3).

*1: being replaced in commission decision of 21 October 2005

*3: being added in commission decision of 13 October 2005

*5: being added in commission decision of 12 October 2006

*2: being added in commission decision of 21 October 2005

*4: being added in commission decision of 28 April 2006

■ **Circumstances safety process management**

In order to satisfy the legal demands, customer demands and administrative system demands, the environmental safety process creates a guideline considering circumstances of safety element such as table 2, this is managing and designing the process. In every stage of administrative activities, environment, safety should be the priority, to minimize environmental influence from the development of the product to manufacture, sales and service activities, we take the environment into consideration and we are implementing environmentally friendly development, hazardous processes or basic material change, polluting material emissions reduction, resource conservation, investment or improvement activities.

Table 2. Main components of environmental safety process at each stage

Stage	Environmental analysis	Establishing plan	Implementation		Inspection	Post-management
Implimentation job	- Legal demands of environmental safety - Understanding environmental considerations - Understanding danger	Mid-term strategy for Environmental safety Installing target for environmental safety Core plan for environmental safety	Environment	Saving Energy Sewage/waste material handling Air pollution material improvement Installation of ecological industrial complex Conservation activities for the environment	Achievement analysis Internal examination Organization of certification Post-examination	Improvement of working circumstances or standardization, administration examination
			Safety	Danger Evaluation Safe working permission system MSDS preparation/ education Researching potential dangers		
			Association	Prevention of emergencies education training		
Related standandard	Environmental law management regulation Environmental effect evaluating regulation		Health and safety regulations management regulations for emergencies		Internal examination management regulation	Administration examination management Regulation

Our vision 「by providing a total solution, creating a clean and productive industrial society, as a leader of the electricity, automation field」, has led to saving resources, reduction of waste material, emittance reduction, and environmentally friendly product development and manufacturing activity.

Based on this environmental policy, through environmentally friendly product and service development, implementation of safe and clean working conditions, we are pursuing new development through harmonization of environment, economy, and society furthermore we will be a globally environmentally friendly corporation which considers the future of civilization and the earth' senvironment.

Also, through the investment in environmentally friendly management we are producing 76% environmentally friendly products throughout our product lines, we are contributing to environmental conservation activities by using energy saving, environmentally friendly, reuseable and refillable products, recycling 80% of total emitted waste material, minimizing polluting material emissions level.

Operating Conditions

3. RoHS Compliance

■ Environmental safety process and management

Also in order to provide environmentally friendly products to customers by implementing environmental effect evaluation of developed products, we are doing waste material reduction, using reusable resources, improving separation convenience, increasing activity of energy efficiency and prevention activities according to EU WEEE or RoHS directives. Especially to not use hazardous materials inside the product, we are managing a data mart by analyzing hazardous materials from the development stage per material. In the future development of products, we are constructing a system to verify (figure 11) hazardous materials such as environmentally friendly product development, we are producing 76% of our entire products, and we are contributing to environmental conservation activities by using energy saving products, environmentally marked products or reusable products. And we are focusing on environmentally friendly product development based on acquired ability to acquire competitiveness of products from a global point of view, securing reliability, and implementation of constant environmental improvement activities, constructing 0-accident operation, control system for polluting materials unit, unified management system of environment

- safety
- quality

we are doing our best to achieve corporation in the future of environment safety.

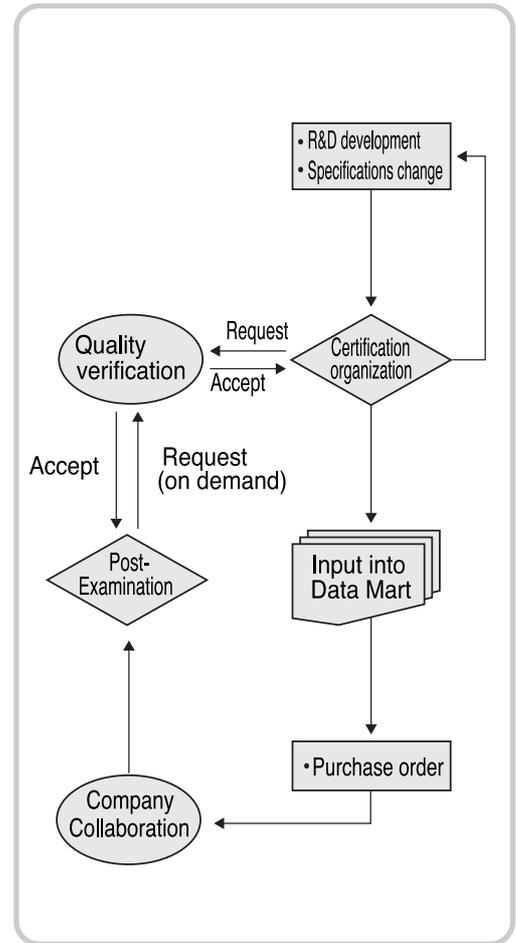

Fig. 11. Hazardous material control

■ Declaration of RoHS compliance

LS Industrial Systems through thorough quality assurance activity and transparent management, guarantees there are six hazardous materials that are being managed within the standards specified by RoHS directive of the EC. Also, for the convenience of the customer, at the LSIS home page(www.lsis.biz) the "Declaration of RoHS compliance" is shown on the bulletin board, please make use of it when needed. You need to confirm on the LSIS home page whether the LSIS product you have selected complies with the RoHS directive before you print it out.

Please contact the sales department if necessary, because RoHS compliant and non-compliant products can sometimes be mixed together due to stock consumption for a certain period or expiration dates after 2006/ 4/ 4.

■ RoHS style Product present condition

1. Metasol series magnetic contactors and thermal overload relays

Dividing	Magnetic contactor									Thermal Overload Relay	Remark
	18AF	22AF	40AF	65AF	100AF	150AF	225AF	400AF	800AF		
Type	6a	9b	32a	50a	75a	130a	185a	365a	500a	MT-12	
	9a	12b	40a	65a	85a	150a	225a	225a	630a	MT-32	
	12a	18b			100a				800a	MT-63	
	18a	22b								MT-95	
											MT-150
										MT-225	
										MT-400	
										MT-800	
RoHS compliance	Complete									Complete	

2. Option

Dividing	Interlock unit (UR+UW)	Surge absorber	Interlock unit	Auxiliary contact unit	Remark
Type	RK - 32	US-1	UR-02	UA-1	
	RK - 63	US-2		AU-100	
	RK - 95	US-3		AU-2	
		US-4		AU-4	
		US-5			
		US-6			
		US-11			
		US-12			
		US-13			
		US-14			
	US-22				
RoHS compliance	Complete	Complete	Complete	Complete	

Dividing	Remote reset unit	Mounting unit	Surge absorber unit	Wire kit unit	Remark
Type	UM-4R	UZ-32	AC-9	UW-18	
	UM-5R	UZ-63	AC-50	UW-22	
	UM-6R	UZ-95		UW-32	
		UZ-150		UW-63	
				UW-95	
RoHS compliance	Complete	Complete	Complete	Complete	

D. Installation

- 1. Storage and Shipping 72
- 2. Installation and Connection 74

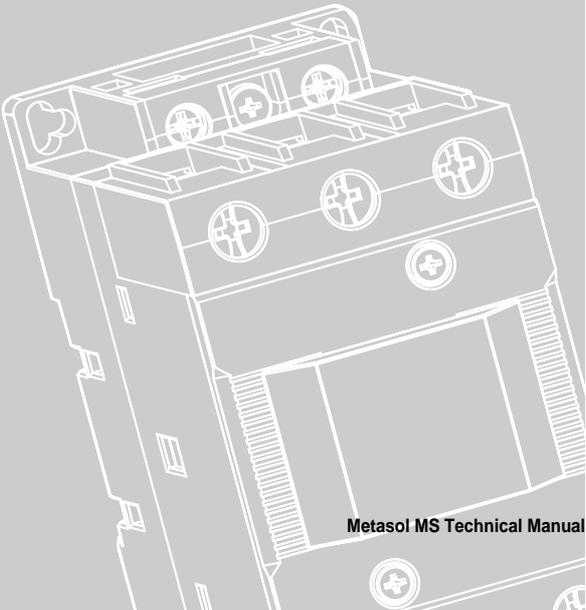

Installation

1. Storage and Shipping



- Please do not damage the product by packing material (paper, wood, nails), edge of product from dropping it.
- Confirm whether it has a missing or damaged part by accident during shipping.
- Don't place it in a humid or dusty environment after opening.
- Do not put anything on the product or step on it.

1.1 Precautions for Storage

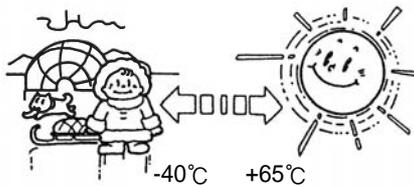

• Surrounding temperature

The surrounding temperature while storing or shipping is recommended to be within the range of -40°C ~ 65°C .

The operational temperature of the general operational range should be maintained.

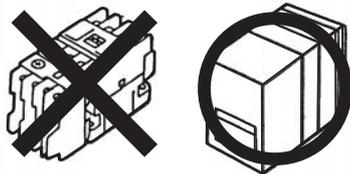

Individual product Packed product

• Storage under packed conditions

Do not store it individually after it's been removed from its original packaging in order to prevent damage, dust, corrosion, be sure store back in its original box.

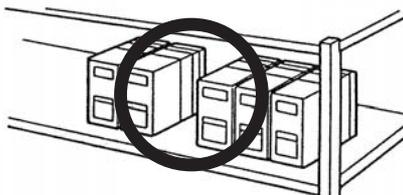

• Storage place

Storage place shouldn't be on the ground (ie. A concrete floor), please store the product on a pallet or shelf and avoid exposing it to direct sunlight.

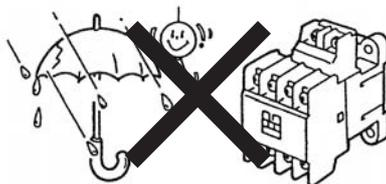

• Avoid humidity

Do not place it in a humid place for a long time.

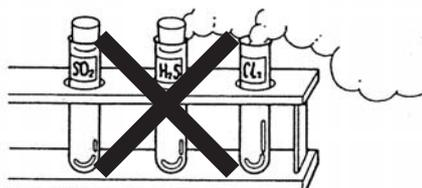

• Avoid corrosive gas

Do not place it in an atmosphere containing hydrogen sulfide gas, ammonia gas, chlorine gas etc.

1.2 Shipping Precautions



- **Careful packing and shipping warning**

Do not drop it while shipping.

Pack it carefully when shipping after wire distribution assembled at the panel.

- **Do not hold or grab the terminals or attached cables while shipping**

It can be damaged or dropped when carrying the product by holding product's terminals, TOR, latch device, cable etc. **Definitely carry it by holding the main body.**

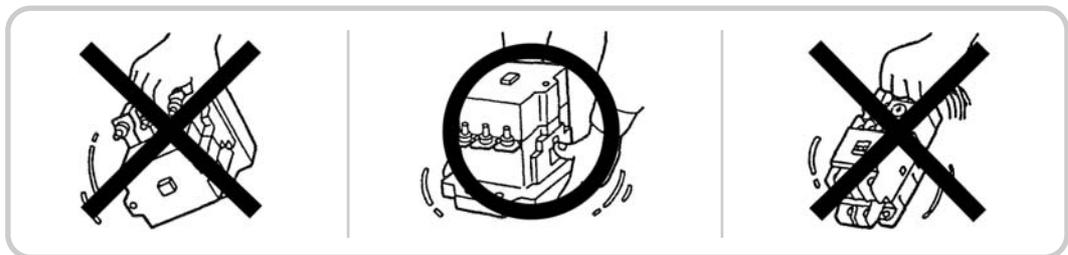

1.3 After Installation, Long-term Inaction Before Operational



It is not used sometimes with current flow for a long term period after completing panel (switchboard, control board). Especially when returning while construction, cement, concrete, moisture, etc. sometimes can penetrate inside.

In this case, please use temporary protection treatment (anti-vibration, waterproofing) until reaching normal driving conditions.

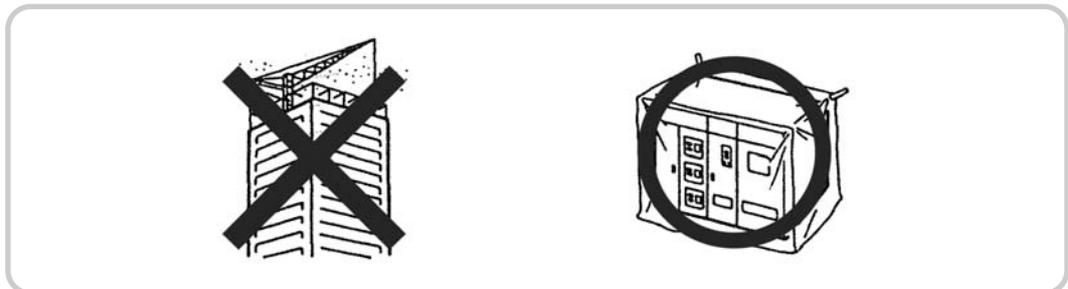

1.4 Packing When Exporting

Normally, the magnetic switch is often exported as a single product or assembly by ship, and often placed for a long time in harbor warehouses. And preventative measures must be considered for the natural environment of salinity and heat while shipping, because it is sometimes passed through equatorial regions in the storage on the ship. The environment influencing exported product passing through tropical areas is high temperature, high humidity, the most influencing thing to the magnetic switch is humidity. Because humidity can be a cause of product rust or mildew, the exported product needs to be treated against this.

Because of this, putting more than 3kg per 1m² of moisture absorbant (silica gel) is recommended for decreasing humidity when packing for export.

2. Installation and Connection



Please stay away from and do not touch this product while current is flowing.
There is a danger of electrocution and burns.



- **Please be careful not to let abnormal material penetrate inside the product during installation distributing wire.**
- **Do not use product damaged by a big shock during shipping/installation**
- There is a danger of dropping when changing the size of installing bolt or shortage of bolts or an unstable attachment to DIN rail.
- **Do not use the damaged product** because there is a danger of overheating, electric short when it is damaged during installation of distributing wire.
- It can not be opened even when control voltage is off because of a loosened wire.
- **Do not manually operate under a live wire condition(when power is on).**
- **Please use the assembled product with closing cover while current is flowing due to danger of electrocution.**
- **Do not attach in the opposite direction of normal attachment (up and down), horizontal floor attachment, ceiling attachment.**

2.1 Operational Place and Installation Angle

1) Environment

- Please install in a place where it is dry, without dust, without corrosive gas or vibration.
- You need to consider protective structure of the case coverin the place where the surrounding conditions are bad such as dusty or much corrosive gas.

2) Installation angle

- Please tighten the terminal screw, with the corresponding assembly torque, corresponding to the terminal screw size, by Item 5 on page 79 “Applicable wires or assembly torque”.
- Regular attachments follows a vertical plane, but it is possible for the attachment angle to be skewed by up to 30° in any direction (back, forth, left or right).

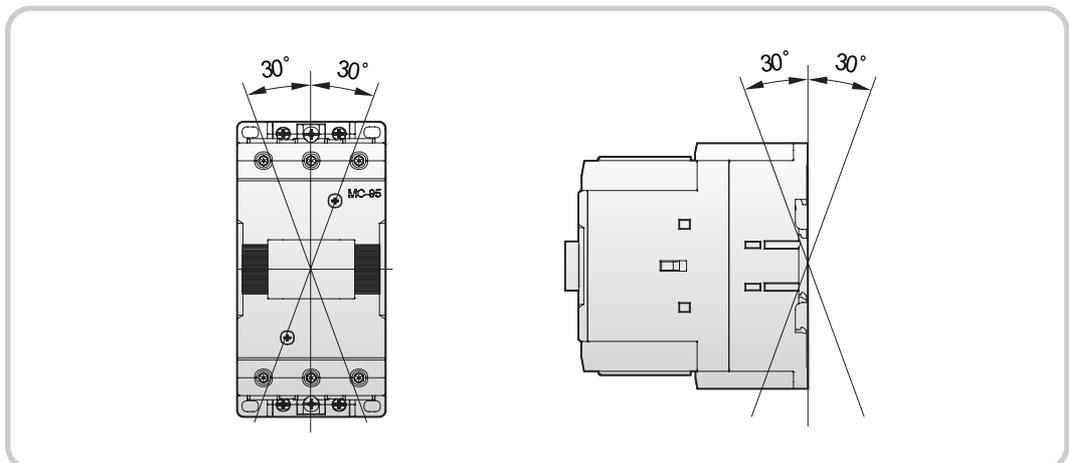

Fig. 12. Tollerable limit of vertical olane

- When lateral installation is needed in wire distribution or installation relation, use the following precautions:

a) Please install with being rotated 90 degrees counterclockwise from standard installation direction as seen in figure 13. If you' re only using the magnetic contactor, any direction is okay.

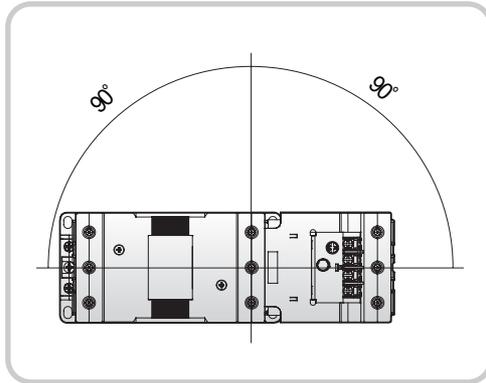

Fig. 13. Lateral installation

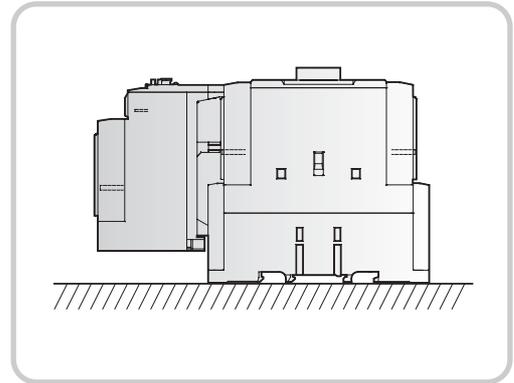

Fig. 14. Horizontal installation

- b) There is no difference with the characteristic of the magnetic contactor when lateral installation, mechanical on/off durability or on/off frequency can be decreased.
- c) Action limit current of the Thermal Overload Relay is slightly changed.
- d) Lateral installation is not allowed for a DIN rail installation.**

Table 2. Assembly state and mechanical life span

Type	Opening/closing frequency (more than times/hours)		Type	Opening/closing frequency (more than times/hours)	
	Standard installation	Lateral installation		Standard installation	Lateral installation
MC-6a~18a	1,800	80% of standard installation	MC-130a, 150a	1,200	80% of standard installation
MC-9b~22b	1,800		MC-185a, 225a	1,200	Lateral routing structure is impossible
MC-32a, 40a	1,800		MC-265a~400a	1,200	
MC-50a, 65a	1,800		MC-500a~800a	1,200	
MC-75a~100a	1,200				

2. Installation and Connection

2.2 DIN Rail Attachment

1) Installation pitch of terminal screw for rail fixture

Rail fixture is recommended to be installed under rail fixture terminal screw pitch from table 3 when it is installed on a 35mm width support rail.

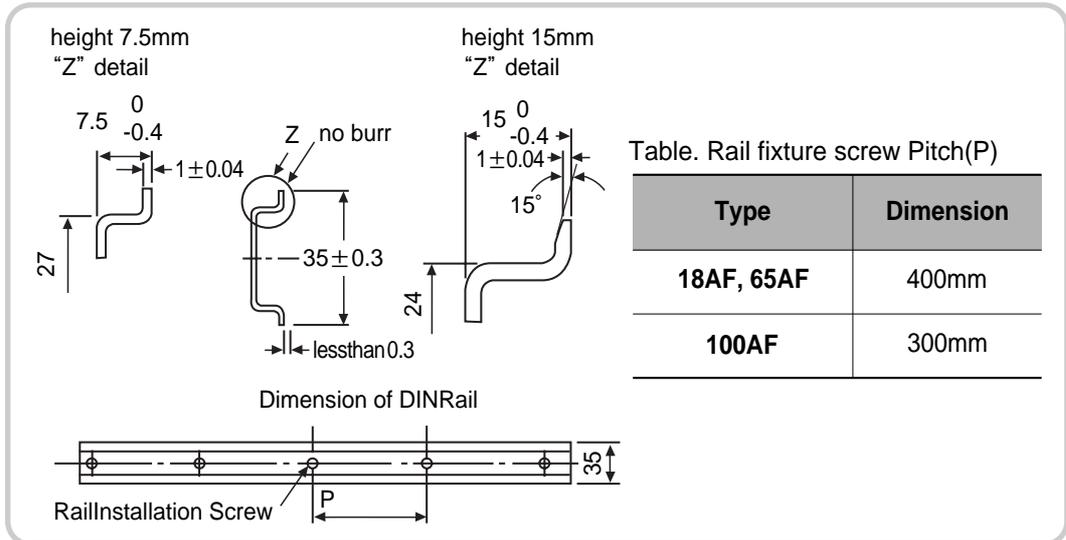

2) Product arrangement on rail

The product interval on a rail needs to be installed more than standard level from table 4. Please use and make sure the minimum interval of magnetic contactor is more than the level from table 4 in order to acquire the insulation distance or heat radiation in the case of close installation of same types of magnetic contactor.

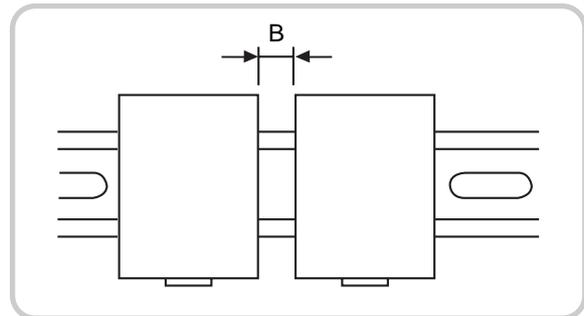

Fig. 15. Interval of product arrangement

3) Rail attachment / detachment

Types	Attachment method	Detachment method
Figure	<p>Hook part Up ↑ Panel Down ↓ Rail Slide part</p>	<p>aCase of the MC-100a Screw driver</p>
Method	<p>Push in the direction of the arrow by hanging the hook part on the rail.</p>	<ul style="list-style-type: none"> In the case of MC-18a, 40a, 65a lift up the bottom when the product is set down. In case of MC-100a move in the direction of the arrow by putting the driver on the main body slide part.

2.3 Installation Minimum Distance Intervals



Magnetic switch Metasol MS is the structure not emitting an arc at the opening of the arc extinguish chamber when breaking the load current, please maintain the interval as seen in the table below otherwise it can cause not only a serious accident but also be dangerous if there are other devices or metal parts around.

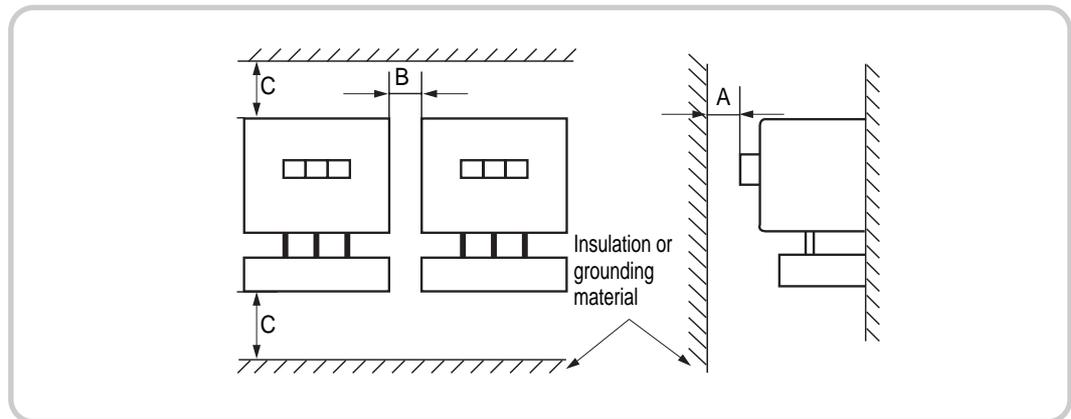

Table 4. Installation minimum interval dimensions

(unit: mm)

Model		A	B	C	Reference
Contactor	Switch				
MC-6a ~ 18a	MS-6a ~ 18a	10	2	15	
MC-9b ~ 22b	MS-9b ~ 22b	10	2	15	
MC-32a ~ 65a	MS-32a ~ 65a	10	4	15	
MC-75a ~ 100a	MS-75a ~ 100a	10	6	25	
MC-130a, 150a	MS-130a, 150a	20	10	30	
MC-185a, 225a	MS-185a, 150a	30	10	50	
MC-265a ~ 400a	MS-265a ~ 400a	50	10	50	
MC-500a ~ 800a	MS-500a ~ 800a	50	10	80	

- **Close attachment is not recommended when installation magnetic switch or magnetic contactor continuously.**
Durability of coil can be reduced by temperature rise depending on operational conditions (continuous current flow operational or close attachment of high on/off frequency product series)
- Characteristic of TOR is changed by the mutual heat influence. Maintaining product mutual interval more than the interval from table 4 is recommended in this situation.
- **A dimension is arc space dimension when safety cover is used.**

2. Installation and Connection

2.4 Terminal Assembly Method



- There is a danger of overheating, fire when terminal assembly is loosened.
- Please assemble with the assembly torque which was specified by this company, tighten it periodically.
- Terminal screw can be damaged when assembly torque is excessive.
- There is a danger of short circuit when compressed terminal, connected conductor (connected to terminal) don't have enough insulation distance.
- There is a danger of overheating, fire when the wire size is not large enough.
- Please use the wire under proper operational conditions.
- When Lock paint etc. is applied to wire contacts or contact points, there is a danger of overheating, fire by fault.
- **Please tighten it completely with the specified assembly torque when the terminal screw is loose. There is a danger of overheating and fire.**

1) Voltage, frequency of coil

The voltage and frequency of the control circuit, and rated indicating voltage of coil and frequency need to be aligned.

2) Self-up terminal screw connection

Connect the compressed terminal as it is, and take off the insulation coating of the wire and then use it. In case of thick stranded wire, divide the strands in two then connect them.

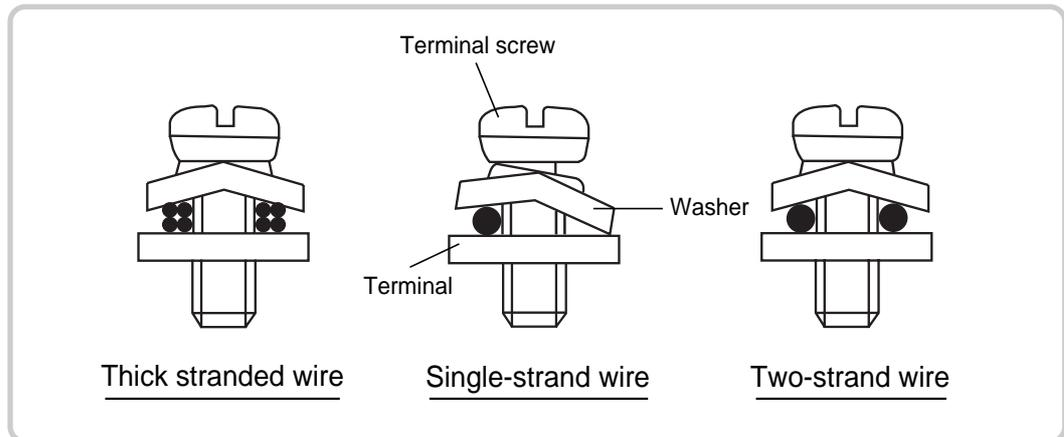

3) It is applied to the circuit 380V

Using insulation tube type compressed terminal is recommended because the insulation distance is not enough due to the inclination of the compressed terminal during wire distribution when magnetic contactor, TOR is used at the compressed terminal connection to the circuit of more than 380V.

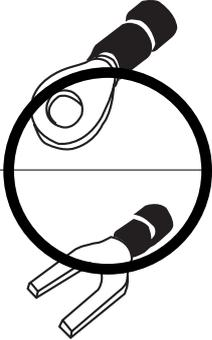
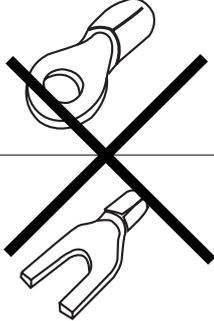
Type	Insulation tube type compressed terminal (PG terminal)	Compressed terminal
O-Ring Compressed terminal		
Y Compressed terminal		

4) Wire and torque apply

Frame	Wire type							Torque
		(mm ² /AWG)						[Nm][lb-in]
MC-18AF		1~6/18~10	1~6/18~10	1~6/18~10	1~6/18~10	1~10/18~8	up to 1.13/10	
MC-22AF		1~6/18~10	1~6/18~10	1~6/18~10	1~6/18~10	1~10/18~8	up to 2.25/20	
MC-40AF		1~6/18~10	2.5~10/14~8	2.5~10/14~8	2.5~10/14~8	1~10/18~8	up to 4/35	
MC-65AF		-	-	-	-	1~25/12~4	up to 4/35	
MC-100AF		-	-	-	-	1~25/12~4	up to 4/35	
MC-150AF		-	-	-	-	1~25/12~4	up to 9.8/87	
Coil terminal		0.5~2.5/20~14	0.75~25/18~12			0.5~25/20~12	up to 2.25/20	
MC-225AF		-	-	-	-	2.5~150/8~300	up to 14.7/130	
MC-400AF		-	-	-	-	2.5~200/8~700	up to 22.6/200	
MC-800AF		-	-	-	-	80~325/ 2/0~Busbar	up to 26.5/500	
Coil terminal		1.25~5.5/16~10	1.25~5.5/16~10			1.25~5.5/16~10	up to 1.75/15	

Installation

2. Installation and Connection

2.4 Terminal Assembly Method

5) General assembly torque

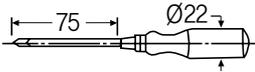
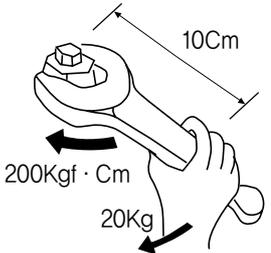
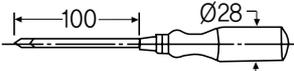
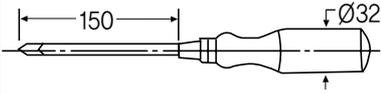
Type	Driver maximum tightening torque (kgf · cm)			Wrench tightening torque (kgf · cm)	
	Screw driver	Both	Right		Left
Form		28	22	20	
		40	35	33	
		58	43	42	
Tightening torque standard	<ul style="list-style-type: none"> Rotate with assembly direction with holding driver horizontally The grip of a man is 50Kg(500N) with the right hand, and 45Kg(450N) with the left hand. 			<ul style="list-style-type: none"> Because the standard muscle of man is about 20Kgf, it becomes 200Kgf·cm of torque when the screw driver length is 10cm 	

6) Burnout by terminal connection fault

When distributing wires at the terminal part, they can finally burn out from overheating by lack of tightening torque or forgetting an assembly screw. **Therefore examine thoroughly when distributing.**

7) Please ground outer housing when case cover is metal in case of assembled type switch.

E. Durability

1. Stresses Affecting Durability	82
2. Durability by Standard	84
3. Contact Point Maintenance Check	85
4. Coil Maintenance and Inspection	99
5. Coil Maintenance	106
6. Thermal Relay Maintenance Check	111

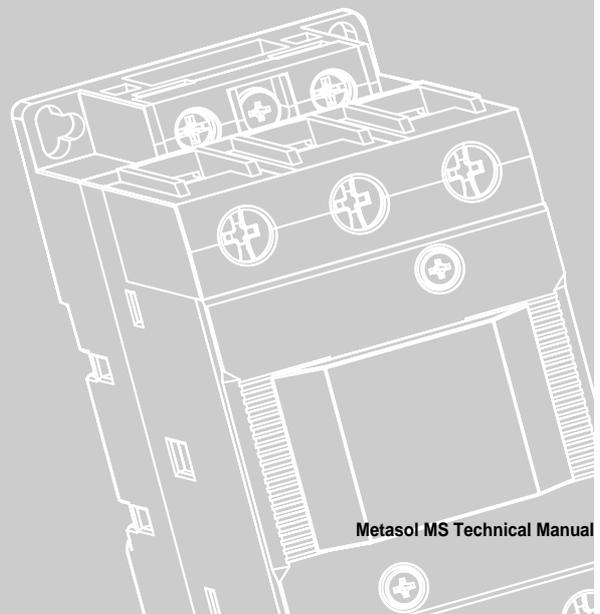

Durability

1. Stresses Affecting Durability

Magnetic Contactors, switches have a limit to durability(endurance), due to area's stress under normal operational conditions. Stress is classified by operational environment such as temperature, humidity, dust, foreign substances, gas, vibration, shock, oil mist etc. and by operational environment such as control voltage, on/off current, on/off frequency, installation, connection. Other than these, stress can influence on durability of magnetic contactor, and switch. Stress is often a combination of numerous factors.

1.1 Durability of Operational Environment Stress

Heating stress classification			Heating action	Heating effect
Top level	Mid level	Low level		
Operational environment	Temperature inside the panel	High temperature	Coil temperature rise	Coil life span decrease
		Low temperature		Coil burnout
		Heat cycle	Freezing	Constraint of movable device(immovable)
	Temperature	High temperature	Core rust	Coil life span decrease
				Insulation decrease, shortage of circuit
	Dust, abnormal material	Contact point part insertion	Contact fault	Contact fault
			Contact point sliding friction increase	Contact point abnormal consumption
		Core contact interposition	Core vibration imperfect absorption	Coil durability decrease
		Movable device interposition	Device sliding friction increase	Movable device constraint (immovable)
	Corrosive gas	Metal corrosion	Insulation decrease	Insulation decrease, short circuit, melting and fusion
			Storage inside insulation part	
		Insulation heating	Core wobbling	Coil durability decrease
	Vibration, shock	Coil terminal screw released	Contact fault	Contact point abnormal consumption
			Insulation decrease	Insulation decrease, shortage
		Main terminal screw release	Continuity fault	Coil fault operation
		Application of movable device	Main terminal screw hit	Contact point terminal part burnout
	Oil Mist	Oil vaporizing by contact point on/off arc	Device sliding friction increased	Movable device abnormal wear
			Contact part application	Contact part fault operation

1.2 Durability Against Operational Condition Stress

Heat stress classification			Heating action	Heating effect	
Top level	Mid level	Low level			
Operational classification	Contact point temperature rise	Over voltage	Coil temperature rise	Coil durability decrease, coil burnout	
			Closing velocity (bounce) increase	Contact point abnormal burnout, melting and fusion Device damage, abnormal wear	
		Low voltage	Chattering	Contact point abnormal burnout, melting and fusion	
			Core wobbling	Coil durability decrease, coil burnout	
		Voltage drop	Chattering	Contact point abnormal burnout, melting and fusion/burnout/melting	
			Core wobbling	Coil durability decrease, coil burnout	
		Voltage variation	Chattering	Contact point abnormal burnout, melting and fusion/burnout/melting	
			Core wobbling	Coil durability decrease, coil burnout	
		Switching current	Overcurrent	Contact point Temperature rise	Contact point abnormal burnout, melting and fusion
				Coil temperature rise	Coil durability decrease, coil burnout
		On/off frequency	High frequency switching	Contact point temperature rise	Contact point abnormal burnout, melting and fusion/burnout/melting
				Coil temperature rise	Coil durability decrease, coil burnout
	Control contact point	Magnetic contactor main contact point chattering	Contact point temperature rise	Contact point abnormal burnout, melting and fusion/burnout/melting	
	Installation connection	Main terminal screw release	Main terminal screw Heating	Arc shortage	
		Coil terminal screw release	Continuity fault	Coil fault operation	
			Chattering	Contact point abnormal burnout, melting and fusion	
		Rated voltage frequency inconsistency	Core wobbling	Coil durability decrease, coil burnout	
			Chattering	Contact point abnormal burnout, melting and fusion	
	Close(no interval) installation	Coil temperature rise	Coil durability decrease, coil burnout		
	Rapid phase change			Mutual shortage	Contact point melting and fusion
	Abnormal inching, negative phase damping			Contact point temperature rise	Contact point abnormal burnout, melting and fusion

E

2. Durability by Standard

Switching durability(endurance) is classified for the standardization between each manufacturer about contact point by consumption of magnetic contactor, switch when on/off action and on/off durability of device.

(1)Mechanical switching durability(endurance) and electrical switching durability(endurance)

There are mechanical durability and electrical durability in switching durability(endurance) of the magnetic contactor, each one is classified by series from 0 to 6 with corresponding to its characteristic.

(2)Indication method of durability(performance)

- a) Mechanical switching durability(endurance)
It is switching durability by mechanical consumption when it is switching under standard conditions without flowing current to the main circuit.
- b) Electrical switching durability(endurance)
It is switching durability by electrical consumption when it is switching under standard conditions with flowing current to the main circuit.

3. Contact Point Maintenance Check



Please perform a maintenance check after turning off the power.
There is a danger of electrocution.



- It may be hot around the terminal from switching.
Do not contact or touch without checking the temperature of the unit.
- Periodically check the consumption condition because of switching durability to the contact point or device part.
- A mechanical device can explode when it is not opened by over current switching, abnormal consumption of contact point or gradual heating endurance.
Please decide the insertion open impossibility by mechanical constraint or contact point melting and fusion and confirm the safety. It is related to performance decrease.
- **Fault operation or fire is predictable by generating contact point melting and fusion when the control contact point generates chattering.**
- When we have smoke due to shortage accident etc, there is a possibility of poisonous gas.
Be careful of inhaling noxious gas.
- Emergency contact point exchange/repair is possible depending on the contact point inspect result. The method of exchange is written in this manual but there is a possibility of shortage, fire from insulation decrease, **with an exchange of a new product.**
- **Please tighten it thoroughly according to its original setting**, when you detach the part for fixing, repair or exchanging.

3.1 The Structure of Contact Point Consumption

Contact point consumption has electrical consumption by contact material differentiated by the current switching and mechanical consumption by insertion shock or friction, mostly electrical consumption.

1) Normal Operational[Category AC-3]

The normal operational method is closing driving current of 3 phase squirrel-cage motor, and the electric flux operating condition occurs. Then the current decreases and closes the circuit, it is called Category AC-3 in KS. In detail, It's the duty of opening one time of the current by closing 6 times of current more than rated operational current as show in Fig.6. In this case, unevenness of the contact plane is relatively small and consumption deformation rarely happens. It becomes covered with miniature black motes at the silver alloy contact point, it has spot partially.

It's not necessary to take care of the contact point during switching in this case. The consumption at each phase contact point of 3 phases is not same with each other, Normally they become much in only 2 of 3 phases. It is caused by contact of 3 phases is not on/off at the same time and the 120° phase difference of current.

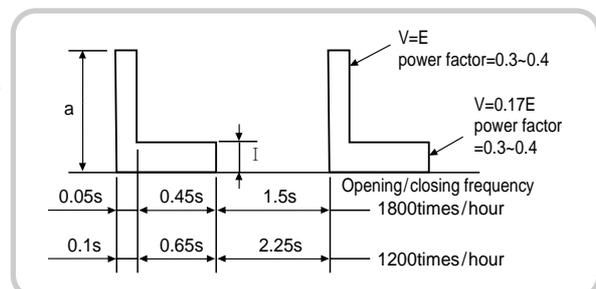

Fig. 16. Category AC-3 electrical switching durability test duty.
I : rated operational current E : rated operational voltage

3. Contact Point Maintenance Check

3.1 The Structure of Contact Point Consumption

2) Inching, plugging [Category AC-4]

Inching breaks driving current before the motor reaches driving speed by stopping the motor frequently. Plugging is a method of generating reverse torque when stopping the motor, it turns on and off the major current which is added to the driving current and plugging current.

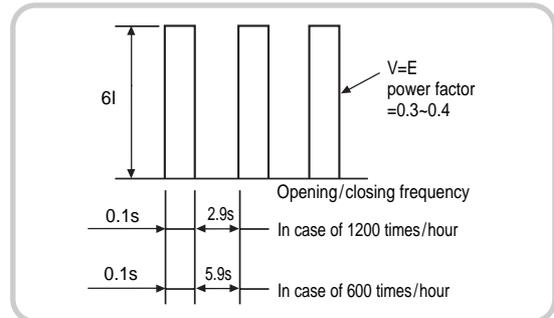

Fig. 17. Category AC-4 electrical on/off durability test duty.

In KS, these methods are called Category AC-4, which should be tested by the method in Fig. 17. It is brutal test to the contactor due to switching the startup current. In Metasol Category AC-4, durability of electrical switching should be over 70,000 times (MC-40 AF standard). Inching exhausts the contactor extremely due to breaking 6 times current of rated current. Ruggedness of the contact plate becomes larger, and the material of connection scatters as the form of powder. On the connection of alloyed silver, black parts are increasing to surface and its outskirts. In the plate of contact, white large speckle comes out.

***You should be aware that chattering causes burning, sticking, and melting of connection.**



3) Abnormal switching due to chattering

Chattering is repeating switching very rapidly, due to abnormal situation such as voltage drop of circuit or bouncing of operating connection. When chattering, immediate action should be taken because repeating switching during the startup current of a motor causes raising the temperature and reducing the durability of connection dramatically.

4) Switching abnormal current

Switching over 13 times current of rated current due to short circuit fault is overwhelmed the capacity of the contactor. Inching makes the connection extreme situation; arc melts the contact plate to damage ruggedness. Insulation around connection turns black by arc, depleted insulation is accelerating, only several time switching makes reuse impossible. More than 20 times current of rated current generates sticking connection, which can be seen due to abnormal current.

5) Oil-stained connection

Using close to machinery, switching with oil-stained connection reduced the durability rapidly. Switching arc decomposes the oil to emit a lot of hydrogen which accelerates exhausting the connection as 1 over several decades as normal situation. The contact plate turns black due to oil and carbon, insulation of its outskirts is soiled, so you may consider the protection or the position of installation.

3.2 Maintenance of Contact point

1) The occasion and method of maintenance of connection

It is tended to polish the contact plate using a grinder when the connection becomes discolored or rugged. This method is for the connection of copper or tungsten, polishing with grinder reduced the durability of the contactor using the connection of alloyed silver. When the connection becomes black or rugged due to usual switching, maintenance is not necessary. For the durability, it would rather not perform maintenance. However, maintenance is necessary when 'burr', or partly severe ruggedness, occurs due to extremely brutal switching, voltage fluctuation, or breaking large current. When the connection is obsolete, it is necessary to change the connection of all phase (Refer to P93 3.3). The method of maintenance shows in Fig. 18, it is not necessary to polish with severe roughness (B) to complete even (B2).

Contact point wear conditions		Contact point repair standard
Tarnishing or slight roughness	Extreme roughness	
	 <p>Extremely rough part</p>	 <p>B2(Please do NOT polish like this.) A(Round type) B(Rough part needing repair) B1(Surface after repair)</p>
Repair not needed	Repair needed	

Fig. 18. Contact point repair method

2) Discoloration of connection

Blackening of electrical connection occurs by sulfur or others. Sulfuration of connection makes it from brown to black due to the thickness of the membrane of silver sulfide from the gas in the air. The cause of sulfuration is hydrogen sulfide from foul water, polluted river, human, exhaust gas, etc, which sulfurates alloyed silver. Silver sulfide is a semiconductor membrane, which is not problem with usual situation or switching frequency, however, it is the cause of bad contact with switching small current or low voltage. Sticking a foreign substance causes the discoloration, black from carbon dissolved by arc, and brown being scattered from oxide. Because silver oxide is not strong insulation membrane like membrane of copper oxide, weak to heat, it can be pyrolyzed at 250°C and destroyed by low voltage, contact resistance is not matter in the circuit over 24V.

3) Temperature rising of connection

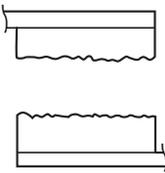
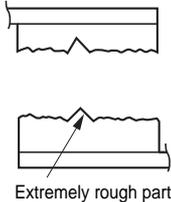
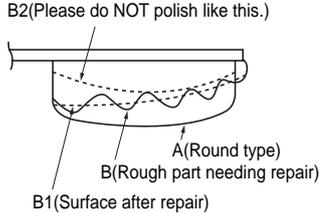
Temperature rising of connection of the contactor is not disturbance of operational, however, it should be limited up to 100°C. Temperature rising of contact terminal is regulated up to 65°C(not including the surrounding temperature).

E

3. Contact Point Maintenance and Check

3.2 Maintenance of Contact point

4) The cause of abnormal exhaustion

When the contactor or switch is not used in the appropriate condition, the connection can be exhausted severely, even sticking by melting.



AC4

- **Inching, plugging**

The ratio of inching/plugging and whole driving changes the amount of exhaustion; however, it is brutal operational, so the contactor with large rated capacity should be selected.

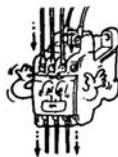

- **Switching abnormal current**

Switching overwhelmed overcurrent of the capacity of the contactor occurs abnormal exhaustion of the connection to result in breaking, sticking, cutting by melting.

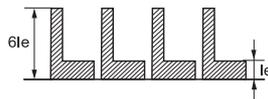

- **Frequency of switching too high**

In the case of switching with high frequency over the capacity of the contactor, the connector is exhausted rapidly and sticking by melting, sometimes.



- **In the case of stained oil connection**

Switching with the contact plate stained with oil which is used by machinery makes the connection exhausted.



- **Phase to phase short from loose main terminal bolt**

Phase to phase short occurs due to loose main terminal bolt or burning the part.



- **Chattering**

When the chattering occurs in the commitment of the contactor, startup current of motor is switched in the frequency of 10~20Hz, so abnormal heating, exhausting, sticking by can be occurred.

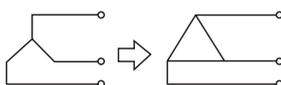

- **Phase to phase short by simultaneous commitment**

① Phase to phase short by simultaneous commitment constant power driving or Y- Δ driving of motor makes the connection damaged severely by phase to phase short which is resulted from rapid transition of phase.

② In the case of using the reversible contact in the place with heavy vibration and shock, wrong sequence checking from foreign, phase to phase short damaged the connection heavily.

5) Chattering prevention

The primary cause of abnormal connection exhaustion is chattering, which is caused by the symptoms described below. It is necessary to increase prevention.

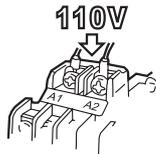

• **Discordance between rated coil voltage, frequency, and source voltage**

- In the case of discordance between rated coil voltage, frequency, and source voltage (ex. In the case of connecting 220V coil to 110V source)
- Coil may be changed to fit the source voltage.

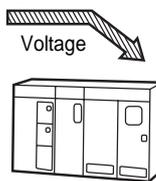

• **Low voltage, rapid voltage drop**

- In the case that commitment of the contactor makes the startup current of a motor flow to make the voltage drop larger (over 35%), the contactor repeats close, voltage drop, open, voltage recovery, reclose, and voltage drop, and a frequency of chattering occurs at a frequency of once every. 20~50msec.
- Due to the causes are described below, maintenance will be required, and since a rapid voltage drop can hardly be measured by a tester, taking a measurement with an oscilloscope is needed.
 - Leakage of source capacity
 - Too small sized wire
 - Too far from source
 - Inappropriate startup (simultaneous startup of many motors)

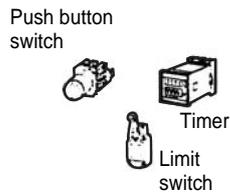

• **Operating connection chattering**

- The connection which controls the coil of an contactor causes chattering by electrical or physical cause from foreign parts.
- When the connection of control circuit is vibrated by electrical or physical shock from a foreign source, the exciter of the operating coil of an contactor can be shorted and cause the chattering.
- The causes are described below, it is necessary to investigate and improve them
 - The connection of relay is vibrated by the shock of a contactor commitment due to install the relay close to the contactor (bouncing)
 - The connection of pressure switch, float switch, or limit switch is vibrated (bouncing). Or, it acts an unstable way.
 - The structure of the pressure or preparation the sticking causes vibration.
 - Insufficient connection for the terminal (badness of screwing and soldering)
 - Because coil voltage is too high, closing impact is big

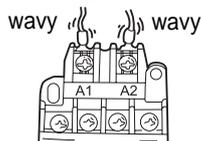

• **Loose coil terminal**

- In case of voltage drop caused by loose of the connecting line of coil terminal screw
- Connect coil terminal with the appropriate torque as the written in the catalog.

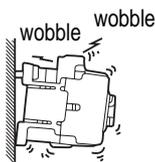

• **Incorrect installation of main body**

- The connection is bouncing as the structure of control board or inappropriate installing of the main body of contactor.
- Install the right method of installation as is written in the catalog. check the structure of control board without vibration of contactor by switching.

3. Contact Point Maintenance and Inspection

3.2 Maintenance of Contact point

6) Connection damage from chattering

Chattering does not only make the connection exhaust abnormally, but also make stick and cut by melting, or phase to phase short if the chattering continues.

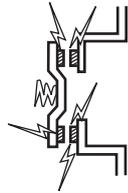

- **Generation of chattering**

Operating voltage drop causes chattering



- **Rising temperature of connection**

Arc due to switching startup current with high frequency generates abnormal heat, so the connection may overheat.

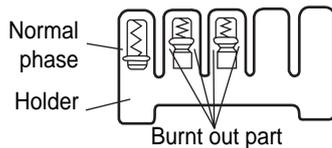

- **Holder burnout**

Heat deformation in the form of pulsation of the holder causes the incomplete contact connection.

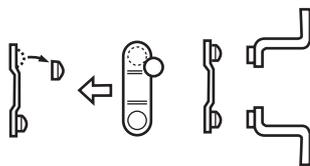

- **Breaking the connection, sticking by melting**

By the abnormal temperature rising causes the position change of the contact part of the connection, for the more, breaking the connection or sticking by melt is occurred.

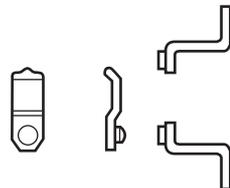

- **Cutting the bar of the connection by melting**

In case of continuing chattering without sticking by melting, the bar of the connection switches the current instead of the connection to cut by melting.

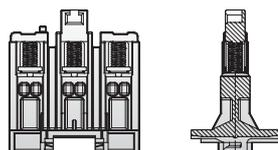

- **Phase to phase short by carbonizing**

Carbonizing the part of insulation by arc causes phase to phase short.

7) Verifying the reason of a burnout

When the electric current closes and breaks at a high frequency due to chattering, the volume of accumulating arc heat surpasses that of the discharging arc heat, and temperature at the contact point will reach around 800°C quickly(3~20 seconds with starting electric current, 20 ~120 seconds with rated electric currents). In this case it will burn out in the process below.

- (1) Heat transformation rises at the sliding part of the holder which sustains moving contact point and this eventually leads to malfunction of moving contact point.

Slide part of the spring holder can be dug out like S, T phase in the following drawing by the heat moving contact point can not be pushed down.

Note) R phase means normal condition.

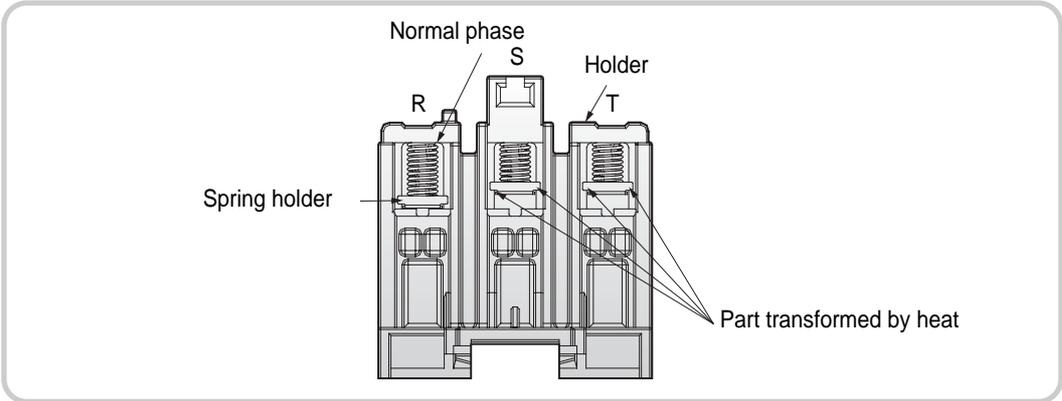
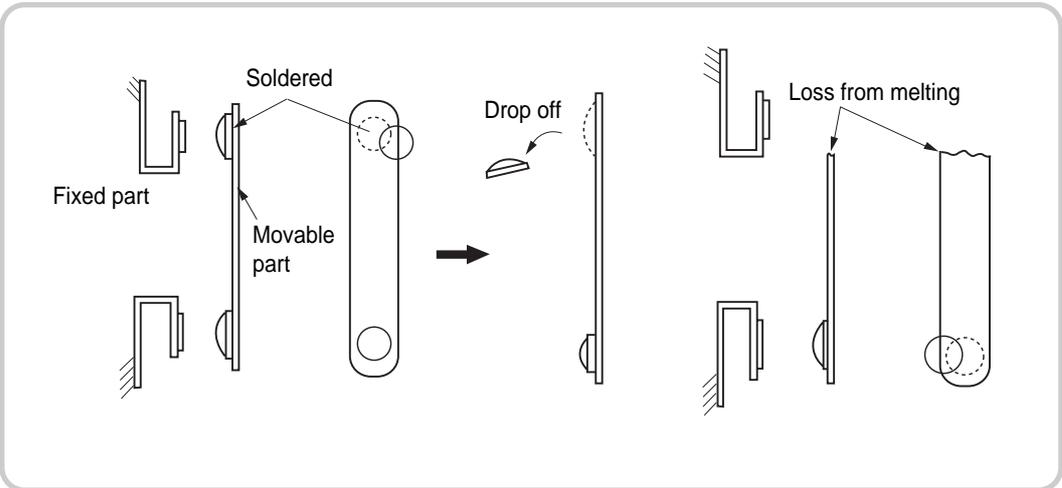

Fig. 19. Mold's sliding part heat transformation during eary chattering



- (2) Because soldered part continues melting, it can cause the difference in location of solder or contact point disconnection.

E

3. Contact Point Maintenance and Inspection

3.2 Maintenance of Contact point

- (3) Rod material can be melted if chattering occurs because the rod material without contact point must open and close the electric currents.
And slide part of the holder will be burned from heat transformation.
Heat can go to the active wire and cause insulation to fade out or melt.
- (4) Accident can stop when electric currents stopped by melted 2 phase contact point in most case. In some case, arc heat can burn insulation part around contact point and cut off between interphase can happen.

These problems are resulting from a burnt out contact point chattering, burnt out problems from abnormal electric currents are a little bit different.

- How to burnt out problems of contact point by abnormal electric currents.
Most of overflowed electric currents such as cut off reach to the melted contact point.
Little care about circuit cut off can lead to melted contact point.

3.3 Contact Point Replacement Standard and Method



- According to inspection results of contact point it is possible to replace it with emergency maintenance and this manual is explaining how to do that, but there is a concern of short circuit and fire from decreased insulation, so please consider exchange for a whole new product.
- There is a danger of fire from contact point melting and fusion which causes worn out contact point. While doing the inspection shown below, please assemble with proper protection devices such as MCCB, fuse, etc.

When it is operating for regular operational, you can decide when to replace the unit by amount of operational days calculated from rated capacity, and operational time. But actually in motor operation there are inching operations etc, a variety of conditions or abnormal wear, so contact point replacement timing needs to be decided by overtravel(OT) decrease (contact pressure decrease) and the level of transformation by wear.

1) Electrical life expectancy

- When thickness of contact point wears 50% of new product or OT reduction reached 60%.
- When severe transformation was found at the contact point and insulation was burnt out.
- When there is fire even when insulation resistance of phases, earthes, or power loads is less than $1M\Omega$ measured.
- When voltage resistance test can not resist 2500V for 1 minute at the same place with(c) (Insulation resistance should be over $0.5M\Omega$).

2) Deciding by OT and contact pressure measurement

Contact point can be worn, thinned out, and pressure lowered with OT by the arc rising from on/off of electric currents. Please check OT and measure contact pressure as reference.

※ Precautions when measuring contact point OT

- Please be sure to shut off the power on the main circuit.
- If you operate after taking arc extinction cover please make sure fingers etc. don't touch contact.

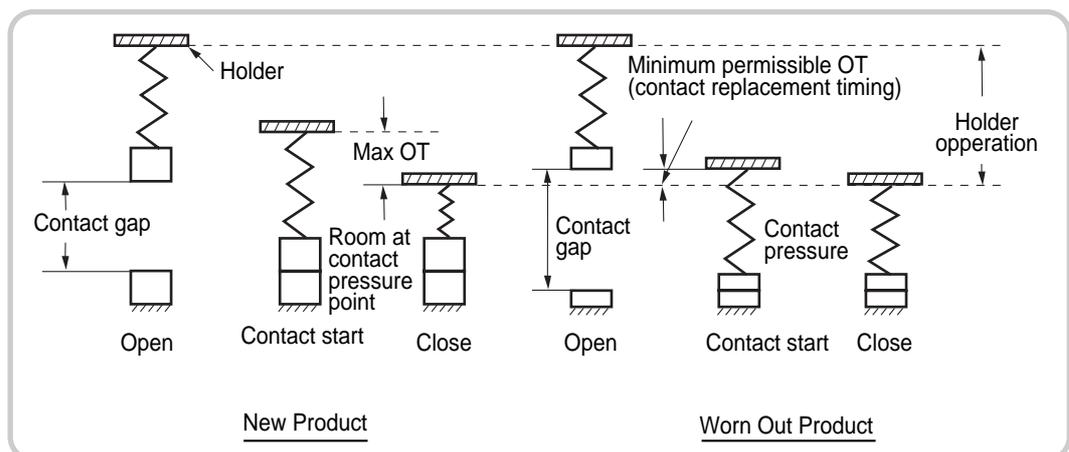

Fig. 20. Pressure change with OT

3. Contact Point Maintenance and Inspection

3.3 Contact Point Replacement Standard and Method

3) Using the naked eye to determine the time to exchange

Determining by OT volume at contact point is restricted to ideal conditions of operation. however, in real situations the form of inter-3phases consumption disparity rises from imbalance by the differences of the 3 phases or form of the switching phase. Sometimes OT can be enlarged in its appearance in case of ruggedness partially. You need to judge exchange time by OT volume and outlook simultaneously.

Description	Category AC-3 (Ordinary start, start finish, stop)	Category AC-4 (Including inching, plugging)
Type of wear	Generally evenly worn out at the end of life. Wear is severe at the end of contact point(much in arc driving direction)	Worn out at the end part is enlarged rather than thickness abrasion of contact point. OT reduction is not revealed when size is reduced even though thickness is enough.
Determining exchange time	You must change thickness of contact point becomes disappeared at the most worn out part or rod material is disclosed at the contact point size from upper side view.	You must change rod material of contact point when it is disclosed certainly.
Consumed appearance		

You can judge average abrasion on the contact point surface because transformation by abrasion of contact point is rarely made evenly. Please replace all the 3 phases with new ones when thickness of the most used contact point L1 reaches under 50% of new product. Actually you can easily read the L dimension including rod material of contact point. Please contact with us on the specification of L dimension. Regarding to the severe ruggedness and abrasion by overuse at the end part, you can change contact point as new one when thickness of curled and ruggedness is close with one of contact point.

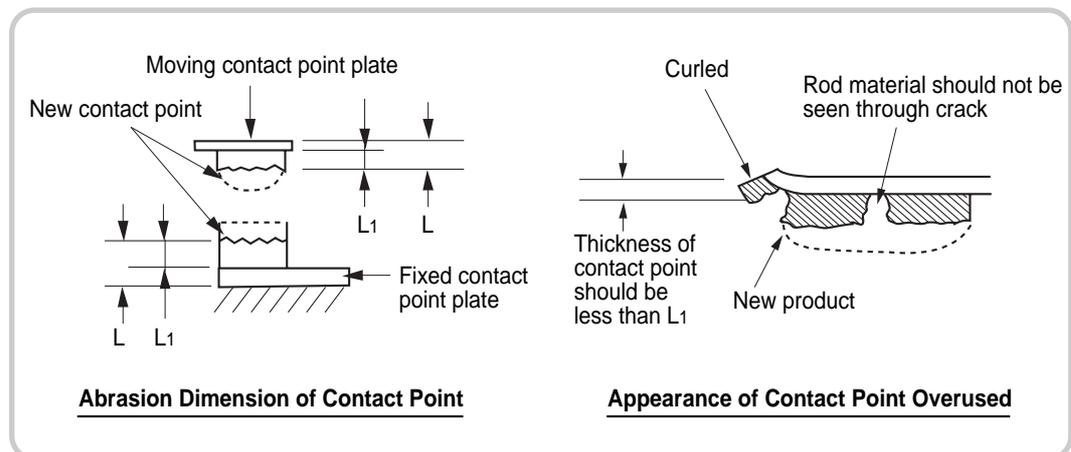

3.4 How to Exchange Contact Point

1) Contact Point(MC-6a~18a)

Order	How to Exchange Contact Point	Diagram
1 1-1	Upper and Lower frame part after opening circled part smoothly using (-) driver. Remove top cover and fixed contact point.	
2 2-1	Pull out holder first. After pulling out moving contact point using tweezers, exchange with new line and main moving contact point	
3 3-1	Assemble fixed contact point after putting back the holder. After assembling the top and bottom, Check whether holder moves smoothly and moving and fixed contact are contacting normally. Then put the top cover back on.	

2) Main Contact Point(MC-32a~40a)

Order	How to Exchange Contact Point	Diagram
1 1-1 1-2	Remove top cover and fixed contact point. Unscrew top and bottom tightening terminal screws. Disassemble top and bottom part.	
2 2-1	Pull out holder. After pulling out moving contact point using tweezers, exchange with a new one.	
3 3-1	Put top and bottom part together and tighten them with terminal screws. After assembling the fixed contact point, please check whether the holder moves smoothly and fixed contact are contacting normally. Then put the top cover back on.	

3. Contact Point Maintenance and Inspection

3.4 How to Exchange Contact Point

3) Main contact point(MC-50a~ 100a)

Steps	How to exchange contact point	Diagram
1	Disassemble lug case and then disassemble top cover and grid. Note) Please be careful not to damage lug case when you disassemble it.	
2	After lifting up contact spring supporter using tweezers, pull out moving contact point then exchange it with a new one.	
3	After exchange of contact point, check whether holder moves smoothly and moving and fixed contact are contacting normally. Then assemble grid and top cover and finally assemble lug case.	

note) After exchange of contact point, please confirm if there is no problem with product's operation (repeat switching several times) and current flow of exchanged contact point.

4) Main contact point(MC-130a,150a)

Steps	How to exchange contact	Diagram
1	Disassemble the lug case and then disassemble the arc box. Note) Please be careful not to damage lug case when you disassemble it.	
2	After lifting up contact spring supporter using tweezers, pull out moving contact then exchange it with a new one.	
3	After exchange of contact, check whether holder moves smoothly and moving contact and fixed contact are working normally. Then assemble the grid and top cover and finally assemble the lug case.	

E

3.5 Contact Point Melting and Fusion

If there are melting and fusion from a short circuit or chattering, please do as follows:

- (a) Light melting and fusion(see P87. diagram 18 “contact point repair method”)

For light melting and fusion, it can be reused by filing contact point. **Please file until ruggedness is almost completely reduced. but do not overdo it.**
- (b) Firm melting and fusion

Please replace with a new contactor when it is tightly melted & fused and you can not detach it. In this case, large arc heat is accompanied most of times so it is necessary to check not only contact point but also insulation of surroundings.
It can not be reused.

3.6 How to Maintain Surroundings of Arc Extinction Room

- There is no problem in the isolation function and life expectancy of contact point even if color fade because we used high anti arc and heat retardant material as insulation at the upper frame in the Metasol series.
- Though Arc runner and grid can be distracted and thin after melted by arc but you need not to change it. (There is no abrasion as much as of giving effect function at normal operational including starting operation.)
- Please remove dust(dissipated metals) and accumulated dust from abrasion.
- Please consider change contactor with large capacity(large rated capacity) because it is presumed damaged by overuse including intercept surge electric current.
 - ① When arc runner is overused and cut down
 - ② When there is hold on the arc box or inter lining on the up frame

3.7 Cautions After Check

- (a) Please install upper frame.

Please install upper frame which was detached as it was. When you would like to operate using operation coil, please start after installing upper frame even if you do or do not apply electric currents on the contact point.
- (b) Please do not push protrusion of motion signal onto the holder when you apply electric currents or not.

You can push protrusion of the motion signal which is shown on the surface of upper frame for check and sequence check. This manipulation is only for check, **and please never do operate while applying electric currents on the main contact point. If you do, it can be the cause of melted & welded contact point.**
- (c) Cleaning of stain, dirt

Please clean up with smooth fabric around insulation barrier inside the upper frame when you change contact point.

3. Contact Point Maintenance and Inspection

3.7 Cautions after checkup



- **Check up should be done at the no power**
Please do check up after verifying the power has been cut.

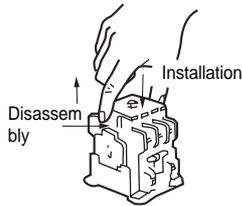

- **Upper frame should be put together surely**
Please assemble upper frame right after disassembling and checking it during checkup or exchange. When you operate with manipulation coil, you should do it after installing upper frame even though you apply or not electric currents on the contact point.

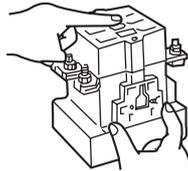

- **Checkup at no load**
Please apply power after doing double check on safety after confirming contactor operating rightly under manual or electric manipulation at no load right after contact point exchange.

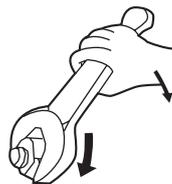

- **Tightening torque should be adequate**
Please use the right amount of torque and fix it tightly when you connect wire to the terminal.

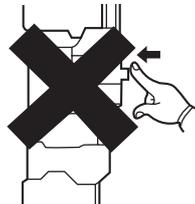

- **Do not touch the main circuit**
It can cause melting & fusion on the contact point when you touch the contactor with your hand.

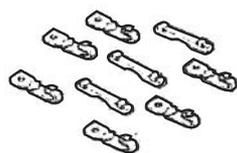

- **Simultaneous exchange of 3 phases when exchanging contact point**
Exchange 1 set of 3 phases moving & 1 pc of fixed contact point simultaneously when the main contact point becomes worn out.

4. Coil Maintenance and Inspection



Please do maintenance and inspection after turning off the power.

- There is a danger of electric shock.
- Do not operate manually while it's live.



- Surroundings of terminal or coil gets hot from switching.
Do not touch with your hand without checking the part's temperature first.
- Because there is coil's life cycle can be reduced by heat,
check for color change periodically.
- If you detach or exchange accessories to inspect or repair,
Please reinstall them as they were carefully and tighten them firmly.

4.1 Alternating Current Electromagnet

1) Electromagnet's stroke and resistibility

Magnetic contactor operates contact point with electromagnet's absorption force. When the moving core is opened, excitation current of coil is very big and absorption force is minimal but after absorbing, it becomes very strong. During that stroke, main contact point starts to contact and resistibility increases suddenly. Then after absorbing, resistibility becomes the maximum and excitation current of coil becomes stable.

And here, there is complete current flow for the first time. Like this all the absorption force parts among all strokes including excursion is operating against resistibility. And if this does not continue even after absorbing, it could cause a lot of problems. The rush current flows during contacting moment of main contact point and it is easy to have voltage decrease. Moreover because contact pressure is low, it is easy moment to occur contact point melting and fusion.

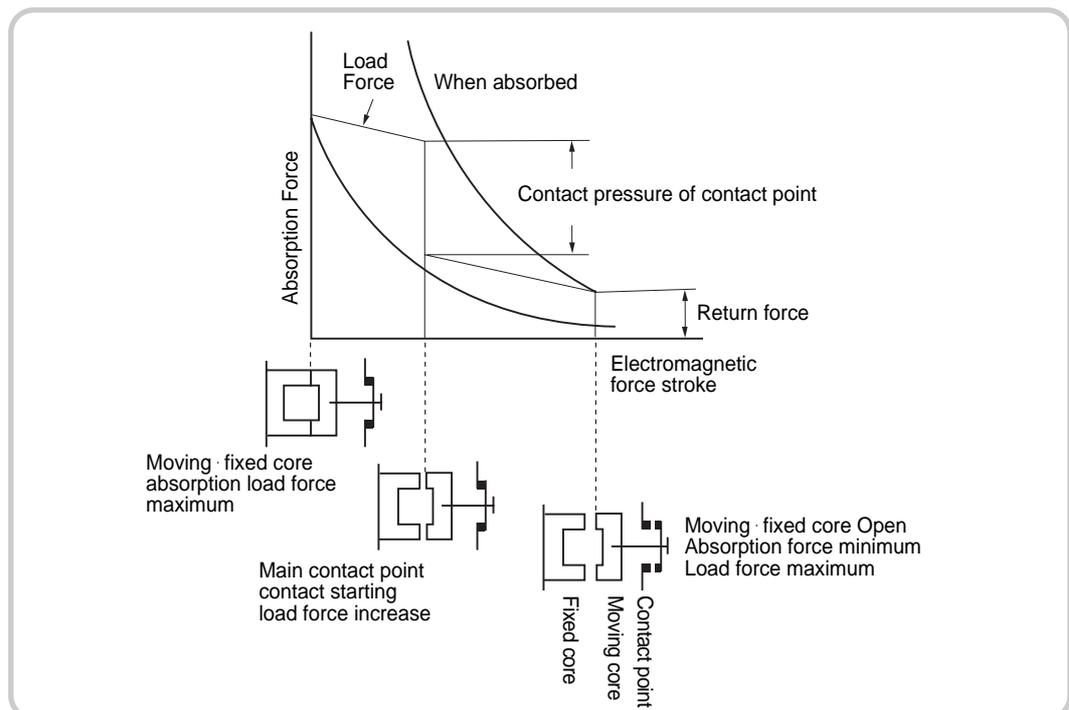

Fig. 21. Alternating current electromagnet absorption characteristic

4. Coil Maintenance and Inspection

4.1 Alternating Current Electromagnet

2) Shading coil

Because absorption force by alternating current transforms by time along with circuit's frequency, with that condition contact resistibility is low and noise occurs then it can't be used. To reduce this noise, shading coil is installed in the core.

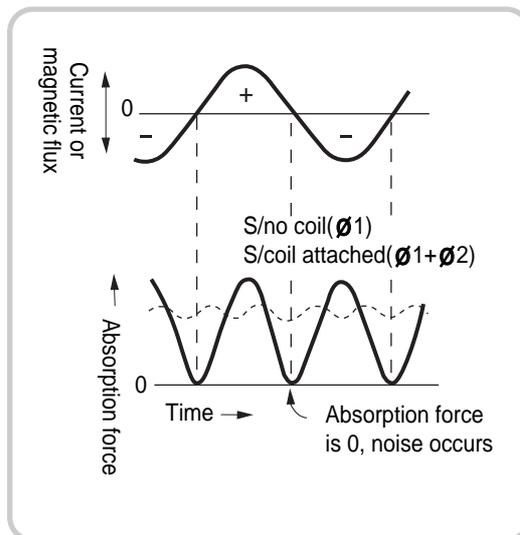

Fig. 22. Alternating current electromagnet absorption

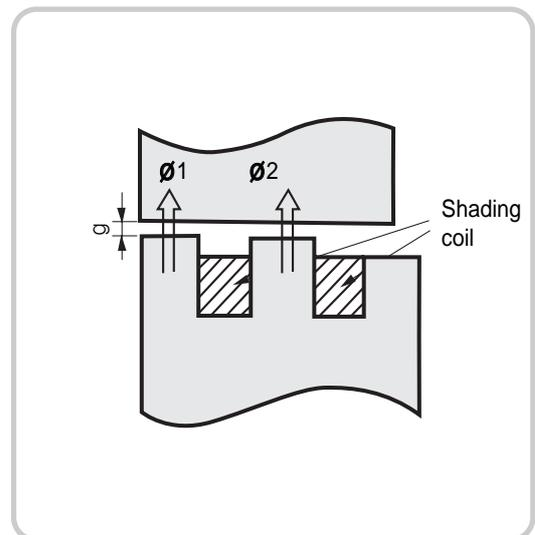

Fig. 23. Shading coil

Because magnetic flux ϕ_2 by shading coil is added to original magnetic flux ϕ_1 , noise becomes very small. Even though it decreases the noise like this, with alternating current, it's not possible to prevent the noise completely. To remove the noise completely, you need to change to direct current operating type machine latch type.

3) Rust and dust on core contact surface

Alternating current electromagnet prevents noise with shading coil but if there is any crack on contact surface of moving and fixed core, the effect of shading coil decrease in half. So we are making contact surface to be smooth and to be rust proofed. But because core is electric steel plate, depending on the operational condition, contact surface can be rusted or dusted during switching. And it cause cause the noise. Especially if the dust contains steam, oil, etc, it has adhesive strength of semisolid and it can cause core opening impossibility. This could be very dangerous.

4) Air gap for residual magnetism prevention

Electric steel plate is used for alternating current electromagnet but after absorbing even if coil power is off, moving core might not move because of residual magnetism. To prevent this opening impossibility, air gap needs to be maintained. The length of air gap is different by size of magnetic contactor but Metasol series are approximately 0.15mm. If the number of magnetic contactor's opening and closing reaches a few million, the length of air gap gets smaller and it causes opening impossibility or noise. This is mechanical switching resistance limit of magnetic contactor.

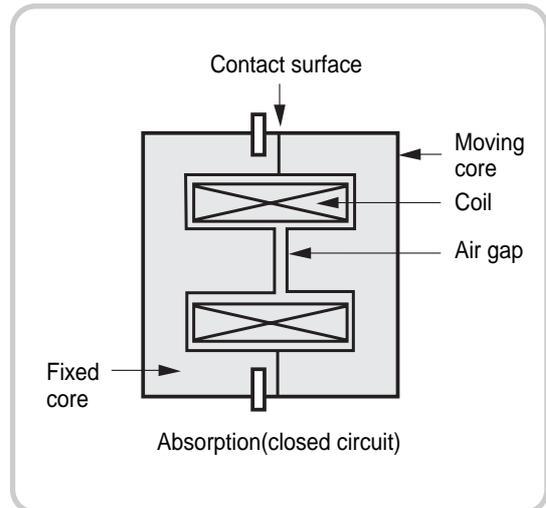
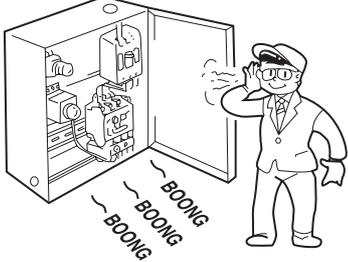
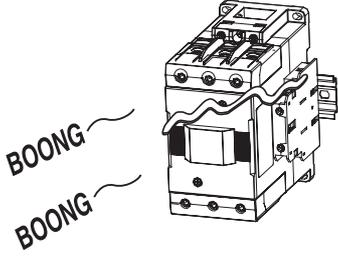

Fig. 24. E Type core

4. Coil Maintenance and Inspection

4.2 Core Maintenance

1) Standard of noise level

Minor noise	Major noise
	
<p>The noise level we can hear 60cm away from the magnetic contactor placed in a quiet room is normal. Coil burnout doesn't happen even in higher level of noise, because excitation current barely increases.</p>	<p>Adequate handling is required when it makes vibration together with same noise level of buzz sound, because excitation current increases.</p>

2) Prevention of noise

It doesn't make a problematic level of noise in general operational, but it sometimes makes noise under operational environments such as high humidity, mote and corrosive gases or condition. Alteration and replacement can be considered when noise easily happens, because direct control type or mechanical latch type is optimal.

Cause of noise	Prevention
<ul style="list-style-type: none"> Abnormal material from the outside such as interposed dust of abnormal material at core absorption side. 	<ul style="list-style-type: none"> Prevents abnormal material, moisture from the outside by the panel. Enclosure of Anti-corrosive, moisture absorbent when it is left for a long time. Maintaining appropriate temperature when temperature change is large and small.
<ul style="list-style-type: none"> Absorption decrease Power voltage decrease Inappropriate operational coil rating 	<ul style="list-style-type: none"> Decrease the voltage variation, use the coil corresponding to voltage at the same time. (85~110% of rated voltage)
<ul style="list-style-type: none"> Break of shading coil Loss of core mid-pole interval Rough biased wear of core absorption side. 	<ul style="list-style-type: none"> Mechanical on/off durability limit of magnetic contactor and replacement
<ul style="list-style-type: none"> Mechanical resonance of same panel installation 	<ul style="list-style-type: none"> Examination of panel structure

3) Cause of noises and prevention

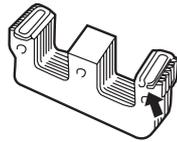

• **Disconnection of S-coil**

When S-coil installed to contact pole for noise prevention is disconnected, please replace with new product, because it reaches the end of endurance.

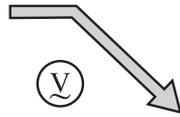

• **Control voltage decrease**

Perfect absorption is not sometimes possible due to lack of absorption force, because voltage of control circuit is too low. Please consider replacing with appropriate coil or increase the power capacity in this case.

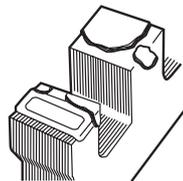

• **Attachment of rust or abnormal material at contact pole plane**

Handle it with the reference of "core restoration and handle" in P83 4.3, in case of imperfect inhalation because of dust, iron particles attachment from rust at contact pole by special operational environment (high humidity, freezing, corrosive gas, dust etc).

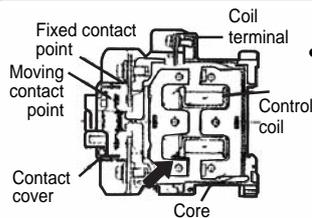

• **Abnormal material in the mechanical part**

When remnants or dregs of molded thing penetrates in the product and cause mechanical wear or bad effect during wire distribution, then remove the remnants or dregs by disassembling upper frame and lower frame.

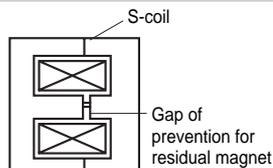

Core before use

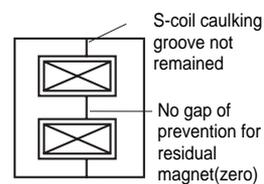

Core after

• **Loss of gap for core residual magnet prevention**

Please replace the main body of magnetic contactor, because it reaches the end of endurance, when moving, fixed core mid-pole contact each other by wear of worked interval for residual magnet for the purpose of on/off fault by residual magnet.

E

4. Coil Maintenance and Inspection

4.3 Core restoration and handling

1) Method of removing rust

- Light rust at contact pole or adhesive adnormal material

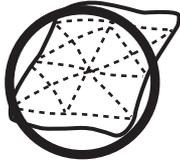

Dry towel

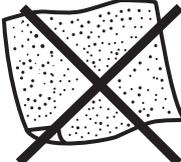

Sand paper



Dry towel



Thinner,
alcohol freon etc.



Wet towel

- Please wipe it with dry towel when rusting occurs at contact pole.
- If using sand paper be careful, it can cause pulsating sounds.
- Please wipe the contact pole with dry towel or towel wet with paint thinner, alcohol, etc. when adhesive adnormal material forms including oil or moisture at the contact pole by the condition or operational environment such as high humidity, condensation, lots of dust, corrosive gas.

• Severe rusting of front of contact pole or material collecting on the device

Please detach it by rubbing with soft wire brush and put on the panel grit 140~300 sandpaper, polish it by pushing hard on the core contact pole. Please be careful with the plane variation of the contact pole, because contact pole is polished with high precision. Please clean it with paint thinner using a clean towel after removal of rust, attached material is over. And please take preventative care to prevent attached material penetration which causes rust. Otherwise, if you don't ensure this fundamental prevention, the corrosion will happen again.

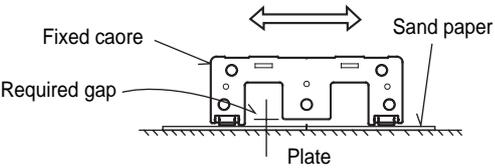
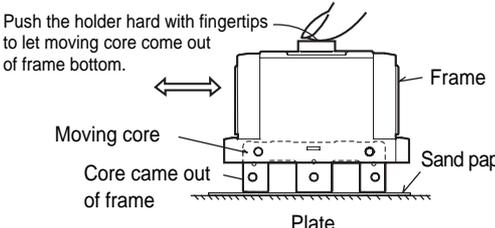
Types	Working method	Judgement
Fixed core		The degree of paper marking at the core contact pole
Moving core		The finish of paper marking at the front

2) Anti-corrosion treatment

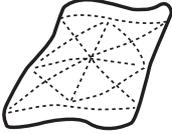
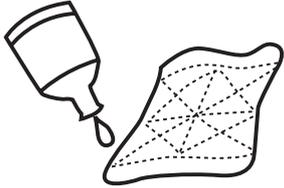
Types	Handling content
Often used	<ul style="list-style-type: none"> • Wiping contact pole is enough without applying anti-corrosion oil when there is often attached material or light rust occurring. • Rust barely happens during use.  <p>Dry towel</p>
Unused for a long time	<ul style="list-style-type: none"> • Wipe the contact pole many times with a towel which has been wet and rung out in case of long term non-use or light rust because of intermittent use. • Please handle it in the same as mentioned above when it is often used (temporary bad condition such as long term non-use) by severe rust occur material.  <p>Low viscosity Trans oil(Trans #2 Oil)</p> <ul style="list-style-type: none"> • Please keep it away from environments where there is a high likelihood of rust or corrosion by putting in the panel which has moisture resistance when it is under possibility of corrosion/rust due to severe rust occur material. • Otherwise, if you don't ensure this fundamental prevention of anti-corrosion, the corrosion will happen again.
 <p>Warning</p> <p>Caution</p>	<ul style="list-style-type: none"> • There are many kinds of sold anti-corrosion oil if you apply to core side, there is an anti-corrosion oil which can easily generate attached material at the contact, be careful because it can cause danger of on/off fault by this.

4.4 Core replacement



There is a danger of fatality or fire because the original function of each part cannot be guaranteed by the mechanical wear of other related parts, in case of replacing only the core. Please definitely replace main body of magnetic contactor when you need to replace only the core.

E

5. Coil Maintenance



- The voltage variation range of the coil is 85~110% but if you use it outside of this range for a long time it may cause burnout, fire by current increase and insulation decrease.

Please use at 95~100% of rated voltage with considering durability endurance.

- It may cause coil burnout, fire in a short time by running more than the designated current rating at coil.
- Although under the permission of low voltage it can not run magnetic contactor.
- There is a danger of coil burnout, fire when it is used in the circuit which has surges and higher harmonic waves.

There is a possibility of noxious gas, when smoke appears resulting from a disconnection accident.

5.1 Coil Maintenance



Please use the designated coil to circuit voltage and frequency and control within permitted voltage variation range (85~110% of designated voltage), there is a danger of coil burnout, fire when the voltage is too low or high.

1) Classification of coil voltages

Rated voltage, frequency are represented by numbers on the coil.

2) Coil variation range

The action range of voltage variation is 85~110% in both cases of AC control/DC control.

- For example, it can be used at 85~110% in case of standard AC220V coil, but it is recommended to use in 95~100% voltage range as much as possible. The insulation durability of the coil is degraded when voltage is over 100%. especially when it is often used for continuous current flow operational be careful, not to exceed the voltage more than 100%



3) Temperature rise of coil

Coil insulation is E-type insulation but temperature rise is restrained as A-type.

Temperature Rise Standard KS C4504
E-Type 100°C[K] A Type 85°C[K]
(surrounding temperature 40°C,
according to the resistance law)

It is not break down within temperature rise written above, although you feel it is hot when you touch the coil. On the other hand, temperature rise according to etype thermal meter law is 80 deg. celcius (reference).

5.2 Coil Durability (Heating endurance) Under Normal Conditions

The coil durability under normal use is mostly determined with winding insulation material and driving temperature. Generally heating aging of insulation material is influence by temperature, durability (endurance) is reduced in half when the temperature rises by 8deg. C .

1) Coil insulation types

E type or B type is taken in control coil insulation, but please refrain from temperature rise level less than 70deg(resistance law) when designated voltage is permitted.

• Coil temperature rise limits(deg) Unit : °C

A type insulation	85
E type insulation	100
B type insulation	110

Note) Surrounding temperature 40°C(resistance law)

2) Coil Durability (heating endurance)

Durability(heating endurance) about continuous excitation of control coil can be estimated as shown in the following figure with the operational surrounding temperature average or harmonization with control coil temperature rise. Decreasing surrounding temperature is effective in extension of coil endurance.

Inside the endurance graph below, IEC, Pub, 172 enamel wire represent the characteristic of heating resistant endurance of coil wire tested by heating resistance endurance evaluation method.

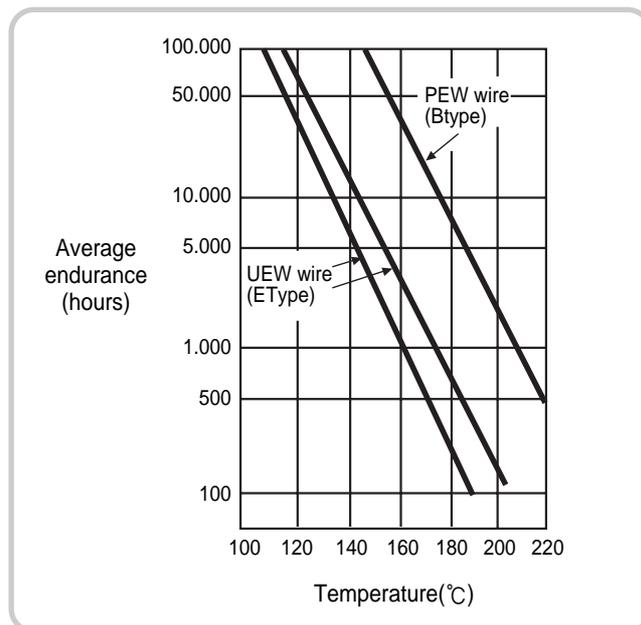

Fig. 25. Heating resistance endurance graph of coil wire

5. Coil Maintenance

5.3 Coil Durability (endurance) Resulting from Misuse



Aging is accelerated when operational condition environment stress etc. is more than normal operational condition. Endurance decrease of coil or main cause of burnout are shown below.

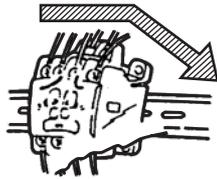

- **Insertion fault**

Coil is burned out by excitation rush current (10~15 times of holding current) flowing into the coil, if you operate it continuously without perfect inhalation after the power voltage decrease abnormal material penetrates into magnetic contact pole.



- **Overcurrent**

Excitation current increases when permitted voltage is too high for coil and, the coil endurance is reduced. In case of high current, coil will sometimes burn out.

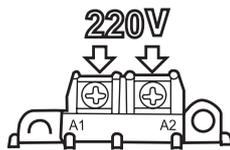

- **Application mistake of voltage and frequency**

It can be cause of coil burnout when coil rated voltage is higher or lower than the power voltage. Coil is burnt out when frequency application is wrong in case of coil which has middle tap of terminal three or terminal four.



- **Excessive switching frequency**

It can be the cause of burnout when it is used more than designated on/off frequency.



- **Closing installation**

Heating emittance installation is accelerated for heating aging by the central coil is the highest temperature when magnetic switch is used at continuous flow current.



- **Chattering**

If contact point has severe chattering by control voltage variation or coil terminal release, it causes coil burnout by drive current flowing into the coil.

5.4 Visual Determination of Coil Burnout

Coil burnout can happen not by simple cause, but by many different mixes of causes, visual determination is difficult after coil is burnt out. In this case detailed situation records, site investigation are required.

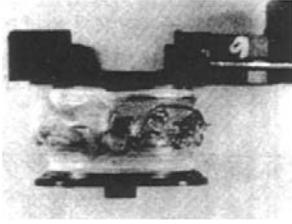
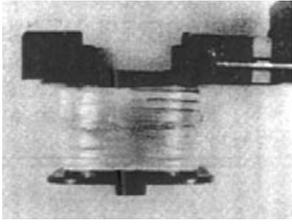
Judgement	Condition	Burnout results
Short-term burnout (a few minutes)		<ul style="list-style-type: none"> • The surface of the coil is entirely swollen up. • It makes brown and black small melted particles on the surface. • It can be seen at the edge of bobbin by burned surface of insulation tape. • Layer short inside coil doesn't generally influence on color variation up to the exterior.
Long-term burnout (more than 10 minutes)		<ul style="list-style-type: none"> • The surface of the coil is entirely swollen up and black. • Insulation tape is burned entirely, compressed. • Many small black particles can be seen out of the surface.

The burned coil for a long time has color change by swelling entirely, but short- and long- burnout conditions can be distinguished by this because short term ones have partial color change.

5.5 Causes and Prevention of Coil Burnout

Cause	Result	Solution
• Use overvoltage 110V coil at 220V	• Short-term burnout	• Replacement
• Inhalation fault by voltage decrease, voltage less than 85% of voltage or use 220Vcoil at 110V	• Short-term burnout • Loud noise	• 100% voltage is recommended • Use DC control type (burnout is difficult because DC coil has no rush current)
• Shortage of chattering power capacity, control contact point(bouncing)	• Short-term burnout (depending on situation) • Contact point burnout	• Increase power capacity • Prevention of bouncing
• Large abnormal material penetration at contact pole	• Loud noise, (burnout time change by the size of abnormal material)	• Prevention of abnormal material by external repairs
• Lair short by penetration such as cutting oil	• Alkalinity cutting oil operational on tooling machinery	• Prevention of cutting oil penetration

5. Coil Maintenance

5.6 Coil Replacing Directions

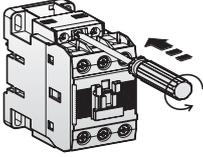
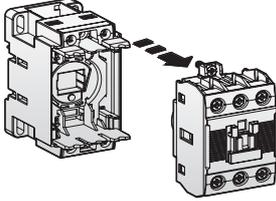
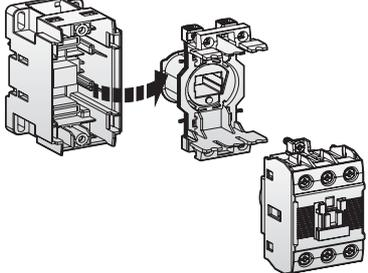
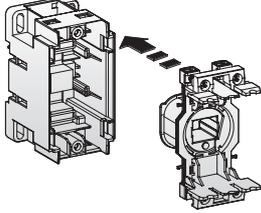
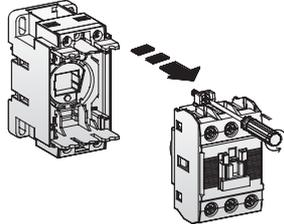
Order	Coil replacing direction	Diagram
1	Release the terminal screw by using a screwdriver between the mid-front and back of magnetic contactor.	
2	Remove the upper frame	
3	Remove the target coil to replace which is installed in the lower frame.	
4	Insert the new coil.	
5	Fix the position slowly with two screws at the front and back of contactor	

6. Thermal Relay Maintenance Check

6.1 Types of TORs(Thermal Overload Relays)

1) Standard type (2P, 3P)

Generally, It is the most frequently used product, it is classified "2element" product and "3 element" products according to the number of installed over current element detecting heater in each phase of internal Bimetal. Fig 26 shows the internal structure of product as below. "2 element" products are normally used in Korea and some Asian countries, it have no over current detecting element structure at "S phase". Operational of "3 element" products are more recommended for more precise load protection. It is also the reason that leading overseas companies use "3 element" products as a standard.

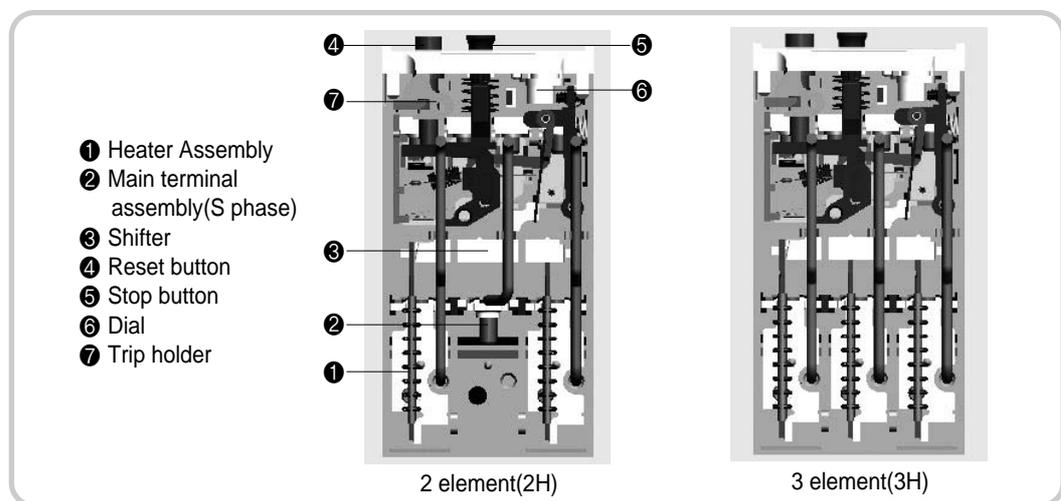

Fig. 26. 2P, 3P TOR

2) For use of open phase protection

This product has the function of "standard type" plus "detecting open phase protection", it is used for prevention of "open phase protection" which is the most major cause of motor burnout. "open phase protection" means the power supplying condition with that 1 phase is disconnected from 3 phases line, about 1.5 times current of rated current on the other phases, internal winding is heated (it causes motor burnout by 6~8 times start current of rated current when start insertion with open phase protection) and it can be extremely dangerous with causing motor burnout. "open phase protection" type product is strongly recommended to use, because it has function of detecting open phase protection differently with other products by the rapid overload current rise when open phase protection.

The mechanical part of the open phase protection product is shown in Fig.27. Open phase protection product which has "ADL(Amplified Differential Lever)" mechanical structure curves 3 Bimetal with a-dimension under rated load driving condition, Shifter-A, Shifter-B, release lever are transferred to the right with a, but contact is not opened. Open the contact with Bimetal curving by b rather than rated load driving condition when overload condition.

6. Thermal Relay Maintenance Check

6.1 Types of TORs(Thermal Overload Relays)

In case of open phase protection, Bimetal of R-phase doesn't curve, but Bimetal of S,T phase curves, so that release lever rotates to the right with the center of connected point by shifter-A, contact open is faster than overload condition, because transfer quantity of release lever expands to lever rate.

namely, motor can be protected with faster open than curving characteristic of bimetal. generally, it's the best way to use protection type of open phase protection among TOR products for motor protection.

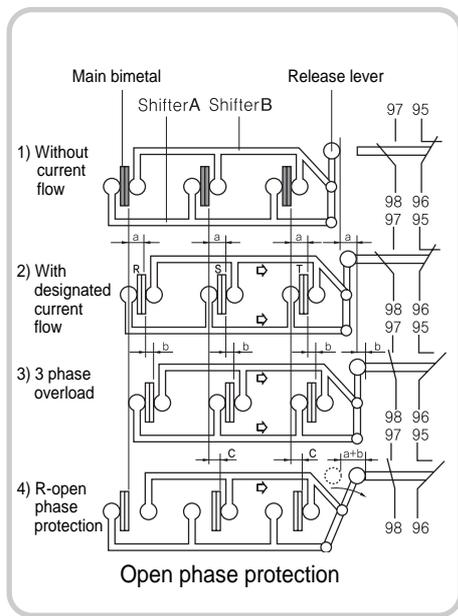

Fig. 27. ADL mechanism

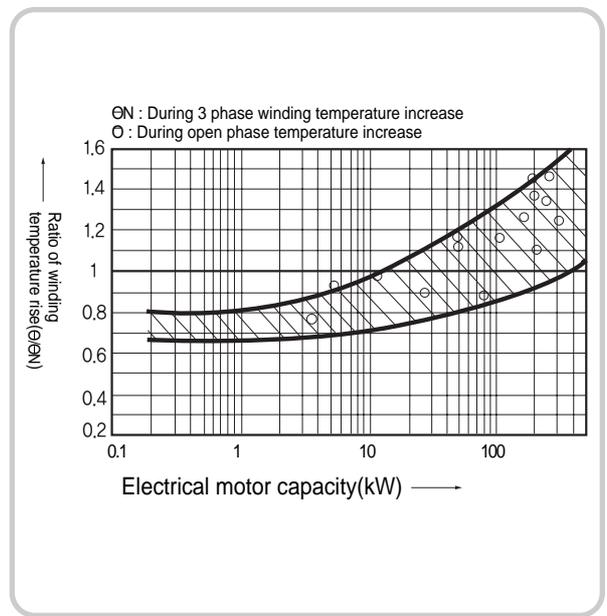

Fig. 28. Temperature rise when driving with open phase protection

3) Time-Lagged Type

It's used for large load inertia such as Blower, Fan, centrifuge which have a long operating time; the characteristic of operation is different from general products. Normal operation becomes difficult by trip while operating, when general type product is used, because operating time is long in case of large overload inertia, Normal operation becomes possible with time-lagged type product. Fig 29 shows the characteristic of general type and time-lagged type products, trip time elapse (when 720% permitted of rated current) is within 10 sec in general type, meanwhile it is somewhat longer within 20sec in time-lagged type.

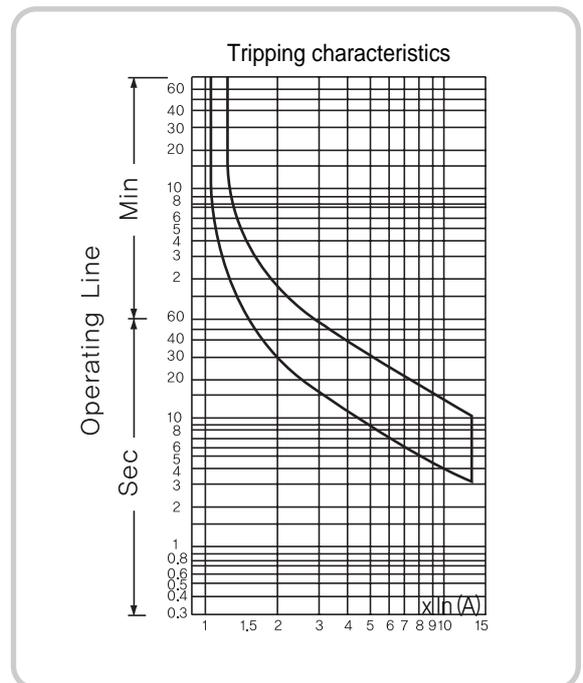
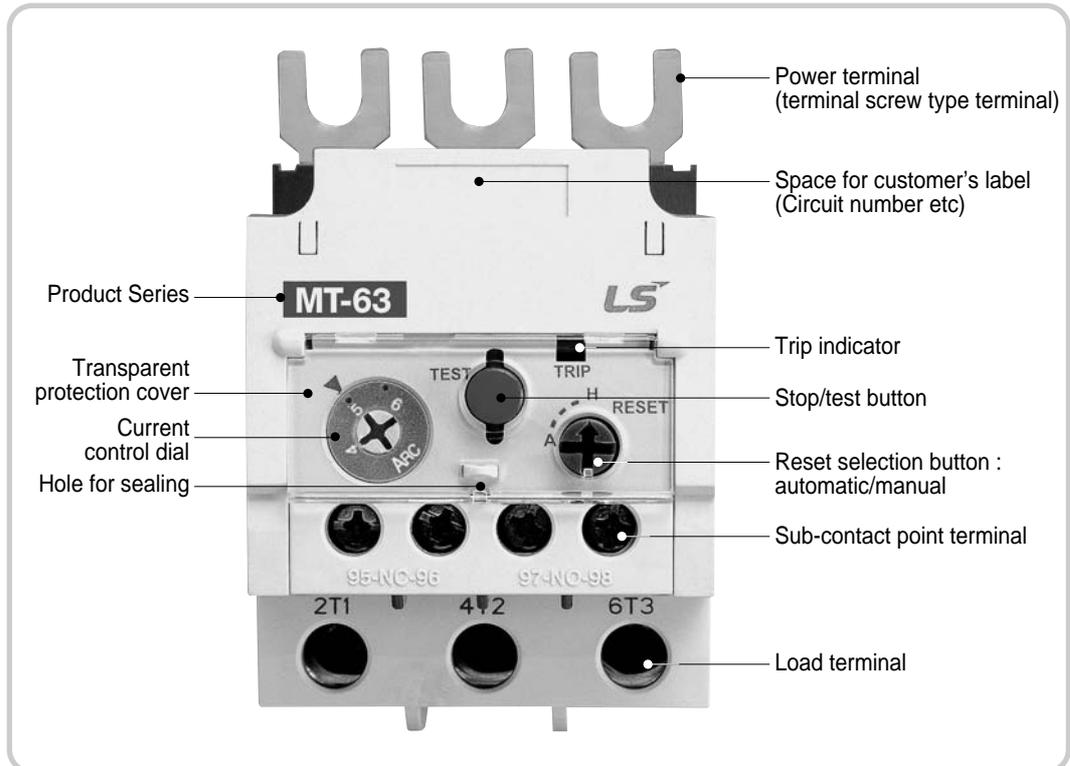

Fig. 29. TRIP characteristic graph of time-lagged type

6.2 Structure or Operation Order

1) Part Names



2) Structure

Set the settling current of dial at the entire load current of motor. Then open up the transparent safety cover, set the settling current value of dial at (▼) by moving settling dial of rated current by driver.

(1) Trip

Tripping is possible without flowing current through the main circuit, because there is a manual trip device is installed at the TOR. Tripping is done by pulling up the red button with transparent cover open.

Operation condition is displayed at trip indicator, a tripped circuit is shown in orange color at indicator, otherwise it displays that the trip is not operating.

(2) Reset

Solve the cause of overload after TOR operation.

Push the green reset button lightly after solving the cause of overload after TOR operation.

3) Terminal

Please be careful with U, V, W, because main circuit terminal is installed at the bottom of product.

4) Contact point structure

Structure of TOR contact point is as shown in the figure, 1a/b is attached. contact point a, b can be used as independent contact, it can be applied with other voltage.

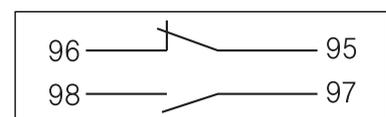

6. Thermal Relay Maintenance Check

6.2 Structure or Operation Order

5) Operation order

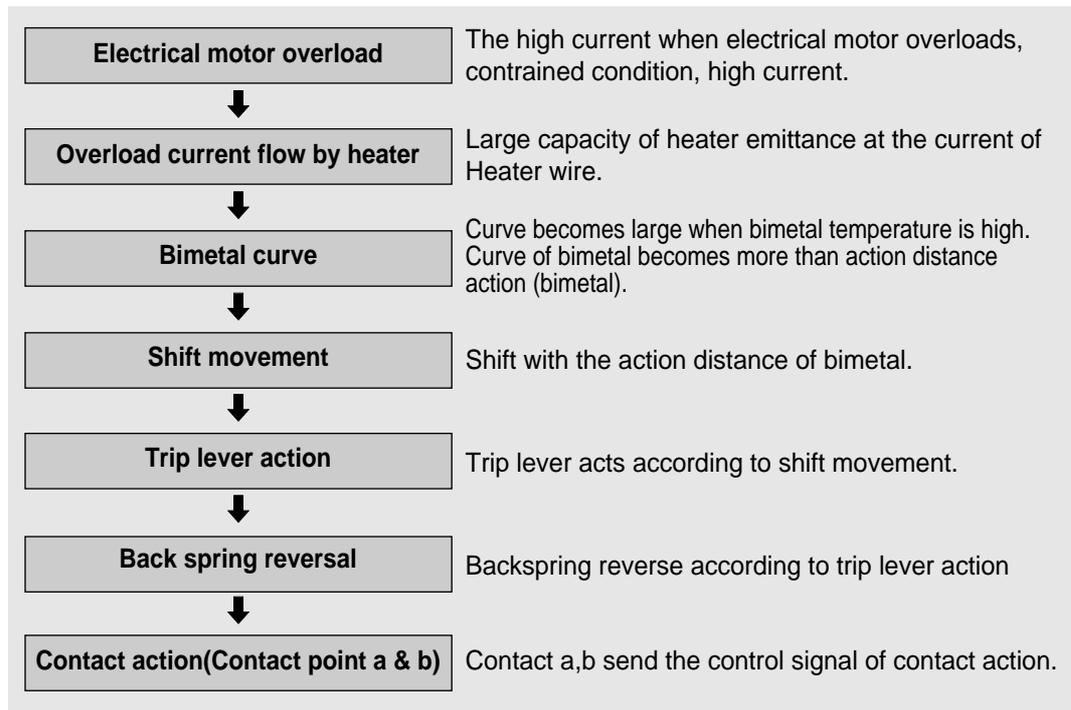

6) Function of each part

- (1) Heat element : Detecting constraint condition when circuit current flows to electrical motor.
 - Heater : Temperature changes when flowing current(I^2R) changes.
 - Bimetal : Curve changes with temperature variation of heater.
- (2) Shifter : It transfers bimetal curve to backspring equipment.
- (3) Release lever : It reverses backspring when bimetal curve is over designated value.
 - bimetal compensating surrounding temperature : It is compensating bimetal so that heater emittance capacity(I^2R) is operating at a constant value even when temperatures change.
- (4) Control dial : It sets the operating current of Thermal Overload Relay. Please use with entire load current of electrical motor when used.
 - Control link : It changes action point (reverse point) of TOR action by the control dial link and bimetal curve.
- (5) Backspring equipment : Backspring reverses by pushing release lever when bimetal curves over designated value, it moves slider to make contact b off and contact a on.
 - Slider, - contact a, - contact b
- (6) Reset stick : It resets by returning backspring equipment by pushing with external force.
- (7) Trip bar : It manually operates the backspring equipment. It is used for checking the control circuit.

6.3 TOR Handling Method



Do not disassemble it. Never contact to inside of the TOR.
It is sold after precise calibration.

1) Current control dial

Control current of TOR is set by turning the dial, selecting the current value corresponding to entire overload current of electrical motor.
For example, use 6A of TOR when entire overload current of electrical motor is 4.8A, and turn the dial, set to 4.8A by opening safety cover as shown in the following figure.
There is a possibility of mis-trip by surrounding temperature, wire size, setting fault, aging variation. Please set it at (▼) by turning dial, and use it.

- ① Current control dial
- ② Stop / Test button
- ③ Operation indication, manual trip
- ④ Reset method
manual reset → Alteration method of automatic reset

Dial control (at 4.8A)

2) Stop / Test button

- (1) Push the test button when emergency stop is needed. In this case, contact “b” is operating only while the button is being pushed (after pressing and releasing the button it will return automatically)
- (2) Pull test button when operation condition check is needed. Point a, “b” operate simultaneously, press reset button for return of normal conditions (will not return to normal conditions if not pressed)
Note 1) Product doesn't have stop mark, but it is distinguished with test button(push is stop, pull is test).
Note 2) Please refer to P116 with contact point conditions.

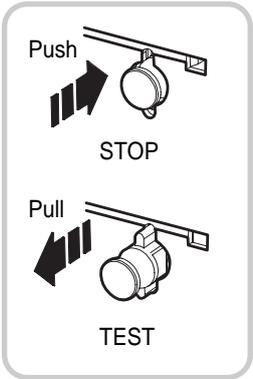

3) Operation indication, manual trip

Trip is possible without flowing current to main circuit, because TOR has manual trip equipped device.

Types	Operation indication		Manual trip
	Reset	Tripped	
MT- 32, 63, 95	No color on trip indicator. No color 	Trip indicator is orange. orange color 	You can cause a trip by pulling the red test button. In this case contact b is off, contact a is on.

6. Thermal Relay Maintenance Check

6.3 TOR Handling Method

4) Reset method

- (1) There are two different reset types, our company's TOR is based on the manual reset type.
- (2) TOR is tripped when there is an over current to the electrical motor. Please reset by pressing the reset bar, after discovering the cause of over current and take preventative measures. You can't reset right after a trip, in this case you can reset when bimetal has cooled. This automatic reset type resets automatically after a short time (10sec. ~ 10min. depending on heating temperature of bimetal).
- (3) Press the green reset button lightly

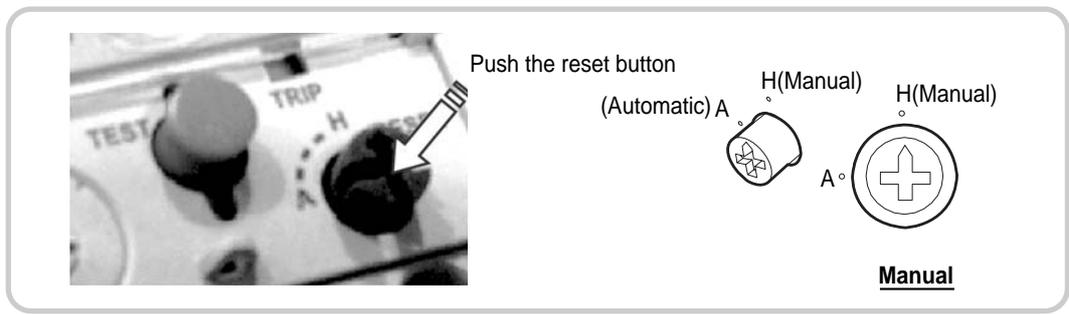

5) Alteration method manual reset->automatic reset

Please confirm the safety with the assumption of an accident with a restart of the mechanical equipment when output contact point is returned to TOR by automatic reset or when recovering from a temporary blackout.

Depress the green reset button with a screw driver and turn it counter-clockwise from H to A.

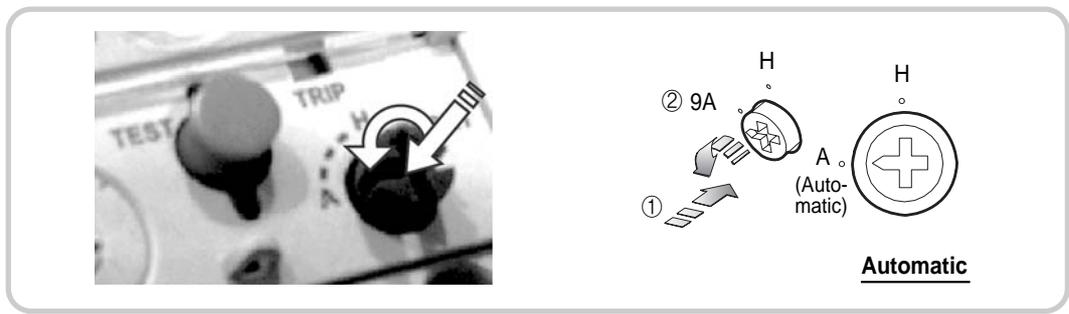

6) Aux-contact condition by operation condition

Terminal number	Standard(Constant)	STOP	TEST/TRIP	RESET
NC 95-96	┆	┆	┆	┆
NO 97-98	┆	┆	┆	┆

6.4 Maintenance Check

1) Fusing of TOR

The TOR is used for the electric motor's burnout protection. When you have a disconnection, replace it. Heater of TOR fused before operation when the current flow is over heater fusing at the disconnection. To prevent heater fusing, please take prevention of the designated capacity of MCCB which is connected to power of magnetic switch.

2) In Case of trip

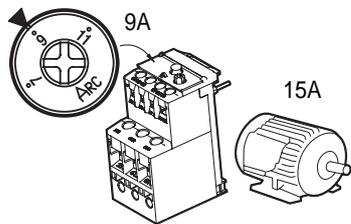

• Mistake of current control
Please set the electrical motor rated current with the TOR dial. It has a trip when normal driving conditions, if it is operated under designated current of electrical motor.

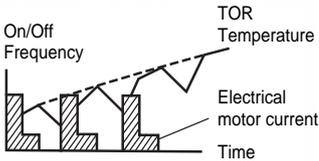

• Switching frequency is too high.
It is not operated at the initial period when on/off frequency of magnetic switch is too high so there is sometimes a trip of TOR after some repetition.

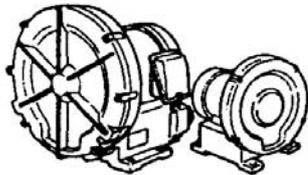

• Driving time of electrical motor is too long
There is a trip when standard is installed for protection of electrical motor which has a long driving time such as a blower or winder, fan, etc. with large load inertia moment. Please install time lag type TOR for mid-level load driving.

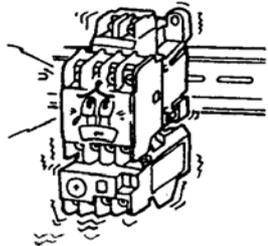

• Vibration of attached panel
The magnetic contactor can be opened by bouncing of TOR Aux contact due to shock resulting from magnetic contactor insertion by panel structure.

E

6. Thermal relay maintenance

6.4 Maintenance Check

3) Cause of Mis-operation and Prevention

It may cause burnout of magnetic switch or electrical motor without TOR trip, when the current is over rated current to electrical motor.

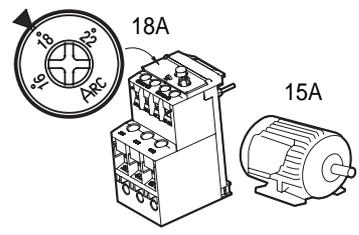

• Current control mistake

It cannot be tripped with motor overload when it is controlled over rated current, because TOR is frequently tripped.

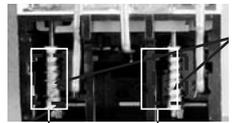

Fusing part



Magnified photo of heater fusing part

• Heater fusing

Heater can be fused instantly when the large current such as disconnection current. For the prevention of heater fusing, you need to have proper prevention over current breaker which is connected to the power of the magnetic switch.

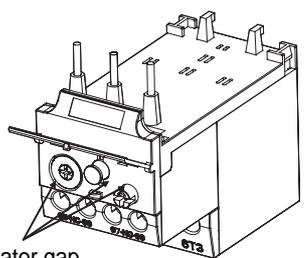

Indicator gap

• Abnormal material penetration prevention of indicator

Please be careful because it cannot be tripped when abnormal material like wire distribution remnant penetrates from indicator. Please use with closing penetration protection cover.



4) Warning

(1) Heater exchange is not possible.

Please replace the TOR main body because TOR is shipped after precise calibration with one in this plant. Exchange of single heater product is impossible.

(2) Internal control is not possible.

Never touch the inside of the TOR because it is sealed after precise calibration.

(3) Terminal position

Please be careful with terminal position when wire distribution because upper terminal is for control circuit distribution, lower terminal is for main circuit wire distribution.

E

F. Accessories

1. Product Introduction 120
2. Interlock Unit, UR 122
3. Surge Unit, US 124
4. Delayed Opening Units, AD 125
5. Terminal Cover, AP 126
6. Insulation Barrier Unit, AI 127
7. Separate Mounting Units, UZ 128
8. TOR Approaching Reset Device, UM ... 129

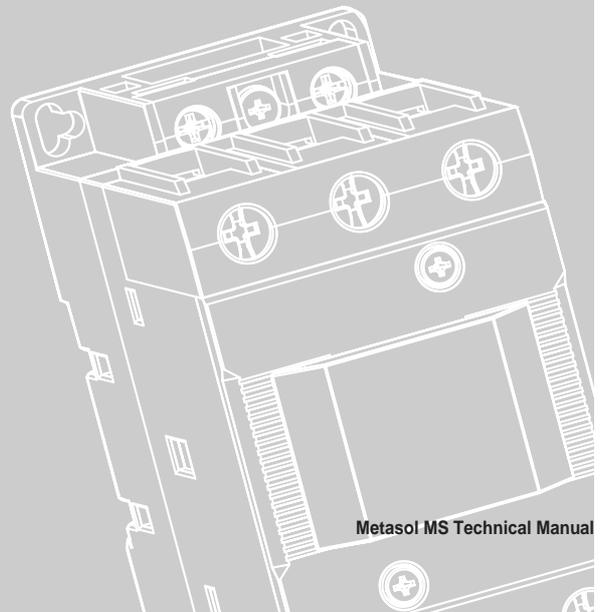

Accessories

1. Product Introduction

It is possible for magnetic switch to be installed with cassette attachment of various option units like additional auxiliary contact unit, mechanical interlock unit, surge unit, thermal overload relay approaching reset device etc. They can be used for circuit alteration, handling improvement and auxiliary accessories.

1. Basic Features

- They are divided by side and front attach to contactor.
- They are used for the common use of every model of Metasol magnetic contactor.

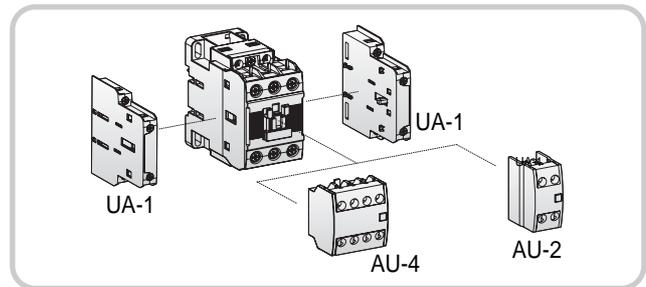

2. Model Name and Description

Type	Diagram	Contact Points / Poles	Composition		Composition	Installation Type	Weight (g)	Apply
			NO	NC				
UA-1		2	1	1		Side	53	18A~150AF
AU-2		2	2	—		Front	28	18AF~150AF
AU-4		4	4	—		Front	50	
AU-100		2	1	1		Side	53	
AU-100E		2	1	1		Side	53	

Note) AU-2, AU-4 are Susol, Metasol accessories and for the common use.

3. Installation Method

UA-1

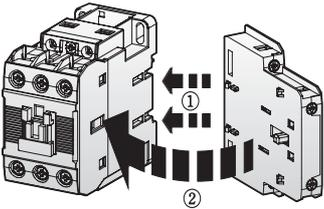

1. Put it very closely and assemble correctly to the notch of holder.
2. Lift it up to the top and take it out to separate.

Note) You can assemble auxiliary contact unit of Metasol MC without pressing holder. But, for Meta-MEC(GMC), you need to press the holder and assemble.

AU-2, 4

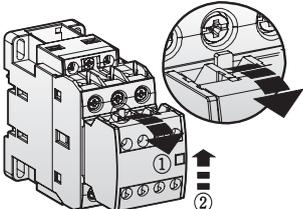

1. Install it while taking it down from contactor's power part to load part.
2. Lift lever up to the top and separate in the direction of number two.

2) MC-130a~800a



AU-100
AU-100E

MC-185a ~ MC-800a

AU-100
AU-100E

F

Accessories

2. Interlock Unit, UR



If you use more than 2 magnetic contactors and make power at the same time, there is concern about short circuit so please be careful.

1. Basic Features

- Mechanical interlock Kit
 - It is a mechanical interlock device for assembling reversible type magnetic contactor and it can be assembled between two magnetic contactor.
 - 2b contact for electric interlock connection is installed inside interlock unit.
 - It is for common use of every model of Metasol magnetic contactor. It is used regardless of capacity and terminal (terminal screw, lug).
- Wire Kit
 - This is a cable set for main circuit connection of reversible type magnetic contactor.
 - Power side and load side are divided.
 - It is divided by capacity of magnetic contactor.

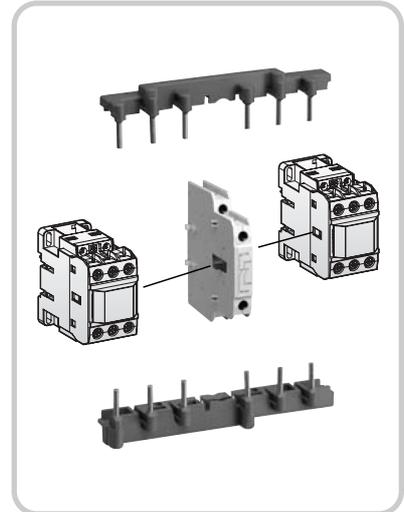

2. Model Name and Description

Applied magnetic contactor	Reversible wire set		Interlock unit	
	Type	Weight (g)	Type	Weight (g)
MC-6a~18a, 9b~22b	UW-18	45	UR-02	64
MC-32a~40a	UW-32	45		
MC-50a~65a	UW-63	120		
MC-75a~100a	UW-95	325		
MC-180a~400a	-	-	AR-180	90
MC-500a~800a	-	-	AR-600	1,520

3. Installation Method

1) UW-18~95

Step	Diagram	Assembly method
1		<ul style="list-style-type: none"> • First, assemble interlock unit on the side of one magnetic contactor. As shown on the diagram, if you connect it while it is aligned with notch 1, you will hear click sound.
2		<ul style="list-style-type: none"> • As shown on the diagram, you can also assemble another magnetic contactor on the other side of interlock unit aligning with notch.
3		<ul style="list-style-type: none"> • Assemble reversible wire set. Loosen the main circuit terminal screw of magnetic contactor by an appropriate amount, put the wire in and then tighten it. At this moment, you should assemble with power side and load side of wire set separated.
4		<ul style="list-style-type: none"> • Please check if assemble of interlock unit and magnetic contactor is correct. • After you finish assemble of mechanical interlock unit, when you press the top part of one magnetic contactor's holder, it should go in smoothly and at this moment, the other magnetic contactor should not be moved. This is a normal condition so please check this repeatedly in turn.

2) AR-180

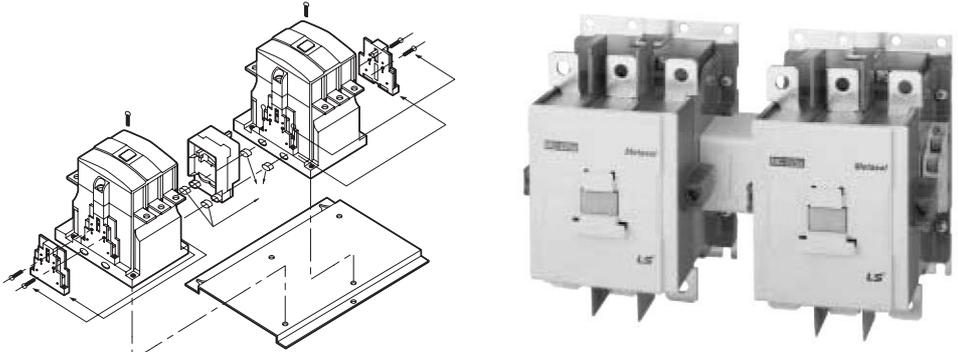

• First detach the auxiliary switch located on the side where interlock is to be assembled and attach it to the opposite side. Accordingly, the number of auxiliary switches is unchanged at 2a2b.



Use precautions

The electric interlock must go side by side by side the b contact of the magnetic contactors on left and right sides. Do not attach the product horizontally.

3) AR-600

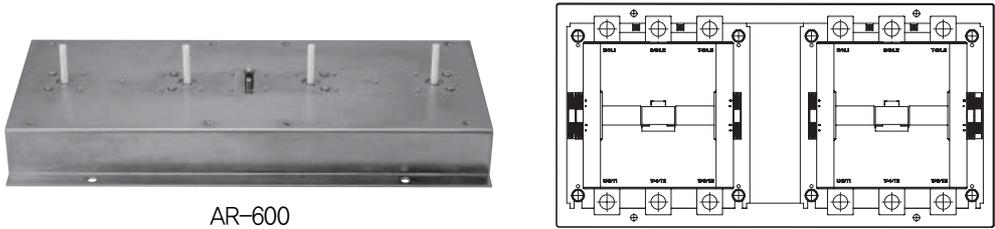

AR-600

F

Accessories

3. Surge Unit, US



- There is a danger of Varistor(used by coil, surge absorber etc.) burn out by heat. **While it is being operated, please don't let it be close to the product or use after assembling short circuit protect device like a fuse etc. on operation circuit.**
- During on and off switching, surge occurs on contact and coil. **By connecting surge absorber, please avoid fault operation or breakdown of electron devices.**
- If surge absorber is used exceeding rated voltage, there is a danger of explosion and fire.

1. Basic Features

- It absorbs surge which occurs from coil during on and off switching.
- It can be attached simply by connecting with coil terminal.
- It is commonly used for every model of Metasol magnetic contactor.



2. Comparison of characteristics

Without surge unit	With Varistor unit	With CR + Varistor unit
Surge voltage, anse when the coil is off, may provoke mis-operation and damage in the circuit	Vanistor has an effect to cut down the peak voltage	Vanistor has aneffect to cut down the peak voltage and high fifth frequency wave
		

3. Model Name and Description

Surge Unit		Rated operating Voltage	Specification			Weight	
Type	Internal element		V	R	C		
US-1	Varistor + RC	AC	24~48V	120V	100Ω	0.1μF	29g
US-2	Varistor + RC		100~125V	270V	100Ω	0.1μF	
US-3	Varistor + RC		200~240V	470V	100Ω	0.1μF	
US-4	Varistor + RC	DC	24~48V	120V	100Ω	0.47μF	
US-5	Varistor + RC		100~125V	270V	100Ω	0.47μF	
US-6	Varistor + RC		200~240V	470V	100Ω	0.47μF	
US-11	Varistor	AC/DC	24~48V	120V	-	-	
US-12	Varistor		100~125V	270V	-	-	
US-13	Varistor		200~240V	470V	-	-	
US-14	Varistor		380~440V	1000V	-	-	
US-22	RC	AC	100~125V	-	56Ω	1μF	

4. Method for installation

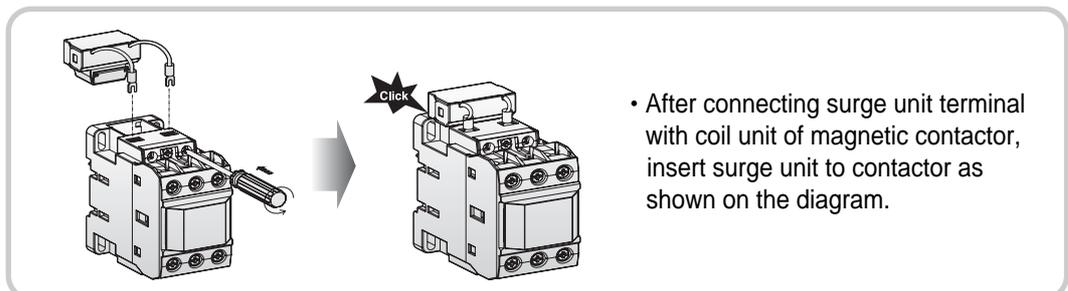

- After connecting surge unit terminal with coil unit of magnetic contactor, insert surge unit to contactor as shown on the diagram.

4. Delayed Opening Units, AD

The delayed release unit combines with the magnetic contactor, and used in important circuits where even in the case of momentary blackout and fall in voltage levels, the contactor doesn't operate. The delayed release unit (AD-) maintains the connection of the mains when a momentary blackout or voltage drops occur due to lightning and such, by means of the capacitor connected in parallel to the coil, for the duration of about 1 to 4 seconds.

1. Basic Features

When changes in voltage is great or for regions where momentary blackouts are frequent, due to the unbalanced power to the coil of the magnetic contactor, chattering may occur even when the contactor is operating normally, which may cause a problem in supplying stable power. Although a design should receive regular power without power interruptions as a rule, like mentioned above when the power source itself is unstable, it is best to use delayed-release or latch magnetic contactors. First, on the delayed release product, it is a product that is used in regions with frequent momentary power interruptions. A separate delayed release unit is purchased for the general type/ magnetic contactor (direct current coil product) and connected to the coil. The delayed release unit supplies power to the operating coil of contactor even if there is a momentary power interruption (1-4s) as a capacitor, installed inside, is charged with some amount of power. Therefore, as power is supplied even if there are momentary power interruptions or voltage drops, contactors don't turn off and there is no chattering.

2. Model Name and Description

Applied magnetic contactor	Type	Control Voltage	
		Delayed opening units	Magnetic Contactor
MC-185a, 225a(225AF)	AD-100	AC 100~110V	DC 100/110V
MC-265a, 330a, 400a(400AF)	AD-300	AC 200~220V	DC 200/220V
MC-500a, 630a, 800a(800AF)	AD-600		

3. Assembly Method

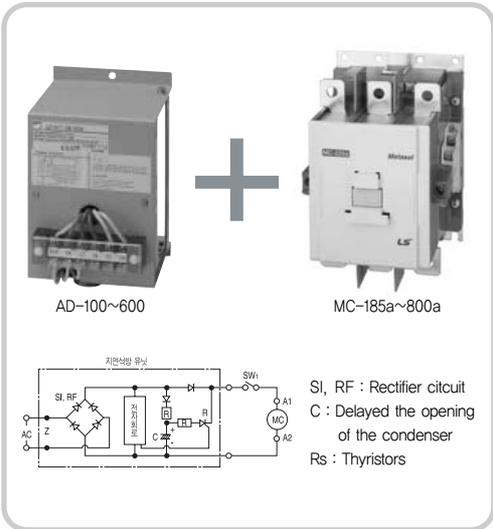

AC power is rectified by rectification circuits SI and RF, charging condenser C, connected in parallel to M C, the coil of the magnetic contactor. When SW1 is turned on, the rectified direct current directly flows through the coil of the magnetic contactor, activating the magnetic contactor. When there are momentary power interruptions, Thyristor Q is turned on (current flows) by the electric circuit in the delayed release unit, and discharged current from the condenser flows to the electric coil through Thyristor Q, delaying the release of the contactor for a specified time. Also, when contact is made open artificially (operating the push button) or when thermal overload relay is becomes operational, the contactor is released regardless of the delayed release unit.



On-off signal of this product should be installed in the DC side, as shown in the figure.

Accessories

5. Terminal Cover, AP

It is an attachment for prevention of electrical shock and foreign substances entering the terminal part

It is an option for those who ordered terminal cover for magnetic contactors or thermal overload relays. (Protection class : IP20)

1. Basic Features

Functions of terminal cover are as below.

- Prevention for front side of arc
- Protection from pollutants like dust
- Prevention from malfunction and safety failures due to any mistake

2. Model Name and Description

Dividing	Type	Applied MC	Quantity	Remark
Magnetic Contactor	AP-9	Metasol	1	
	AP-220	MC-185a, 225a	2	
	AP-400	MC-265a, 330a, 400a	2	
	AP-800	MC-500a, 630a, 800a	2	
Thermal Relay	APT-225	MT-225	1	
	APT-400	MT-400	1	
	APT-800	MT-800	1	

3. Installation Method

- AP-9 is installed at front side of Metasol series MC.
- AP-220~800 are installed at terminal side of power and load side of large capacity Metasol series MC.
- APT-225~800 are installed load terminal side of large capacity thermal overload relays.

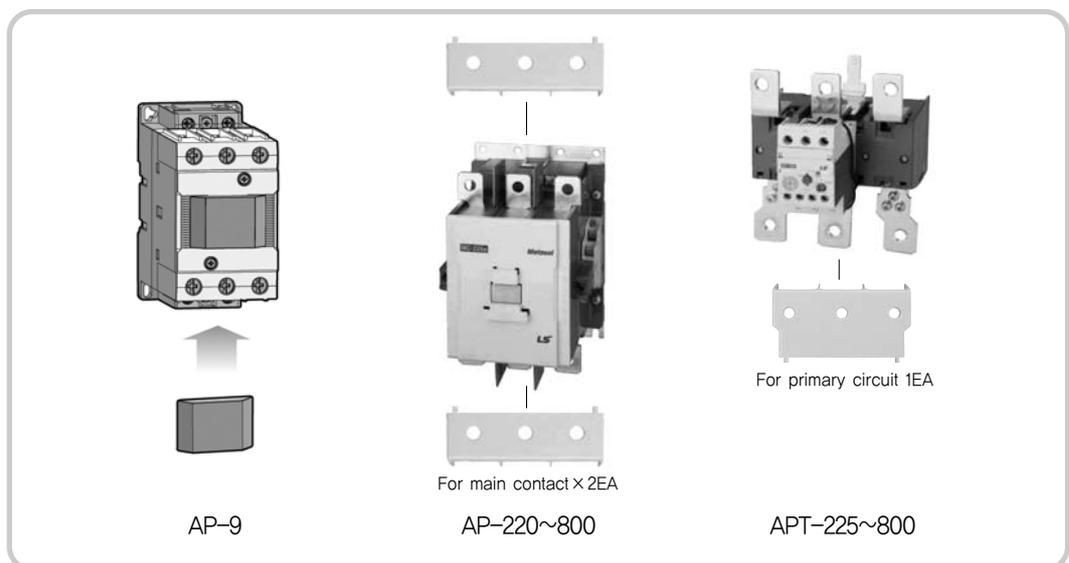

6. Insulation Barrier Unit, AI



Used for isolation from the main circuit of magnetic contactors

Applied magnetic contactor	Type	Remark
MC-185a, 225a(225AF)	AI-180	Quantity per 1magnetic contactor : 4ea
MC-265a, 330a, 400a(400AF)		
MC-500a, 630a, 800a(800AF)	AI-600	

Accessories

7. Separate Mounting Units, UZ

For Y-D configuration, there is a need to install thermal overload relays independently. For small capacity products (below 80A rated current), they can't normally be installed independently, but it is possible to do so using an attachment. The below figure shows combining with independent installation unit. For large-capacity products of over 100 AF, independent installation units are not used like for small capacity units, but they are designed so that they can be directly attached to the panel. (For large capacity of over 600AF, sometimes installation is done on a separate attachment panel as external CT, etc, are used.)

1. Basic Features

- Used when thermal relays are installed independently.
- Installation can be done by screws or on the DIN rail.
- Connection is simple with Meta-MEC contactor.

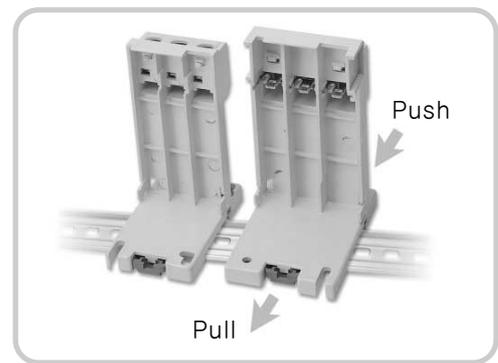

2. Model Name and Description

Type	Separate mounting unit		Remark
	Overload relay	Weight (g)	
UZ-32	MT-32/2H, 3H, 3K, 3D	68	
UZ-63/S	MT-63/2H, 3H, 3K, 3D	134	
UZ-95/S	MT-95/2H, 3H, 3K, 3D	230	
UZ-150/S	MT-150/2H, 3H, 3K, 3D	234	

3. Installation Method

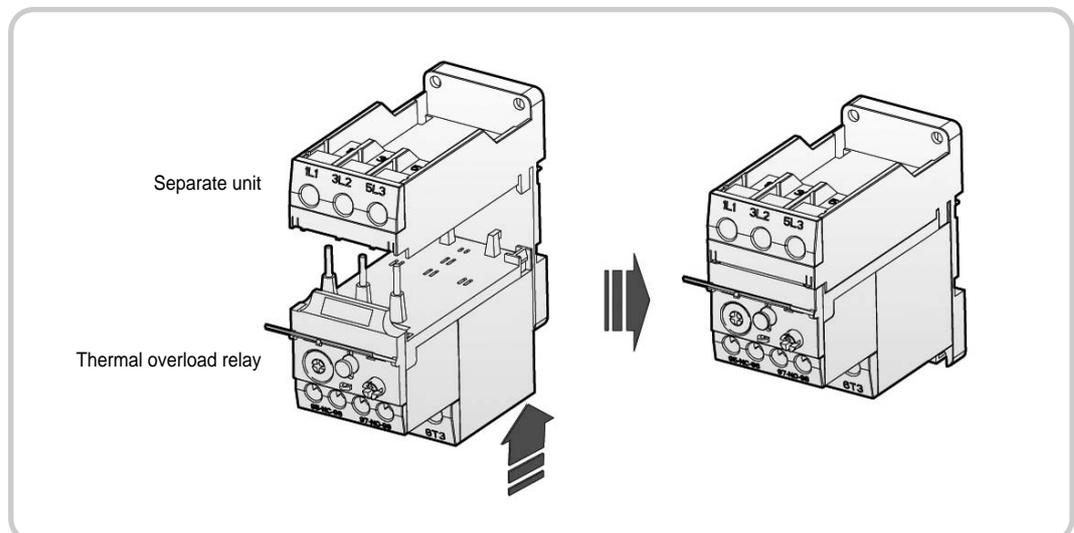

8. TOR Approaching Reset Device, UM

In the case of attaching reset release additionally, TOR reset is possible for approaching control. The length of release indicates the length between surface of installation point and fixing tool, so please select from table 6.

1. Approaching Reset Device

In the case of overload relay is being tripped, it makes the panel door reset without operating reset button of relay. It is for common use of every frame.

Table 6. Cable length by type

Type	Cable Length (L)
UM-4R	400 mm
UM-5R	500 mm
UM-6R	600 mm

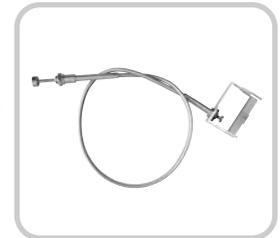

- ① When you install it, please make sure lead unit of reset bar doesn't bend within 55mm from panel and 35mm from installation support frame.
- ② Please set the radius of the bent part of reset bar's lead unit above 15mm.

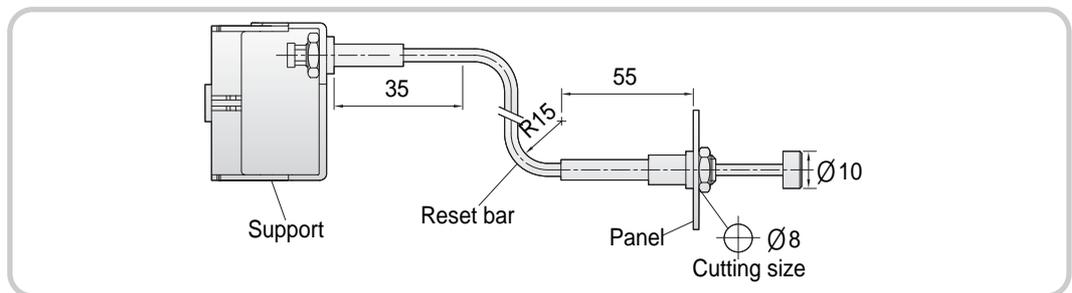

2. Installation

- 1) Please insert projection (*1) of support frame into the edge and hole of thermal type overload relay.
- 2) Please separate the nut(*3) and the head cap(*4) from reset bar and insert the reset bar into the back of panel, then fix the nut(*3) and the head cap(*4) from the front of the panel to the reset bar.
- 3) When you separate the support frame from thermal type overload relay, please lift up *2 part and then separate.

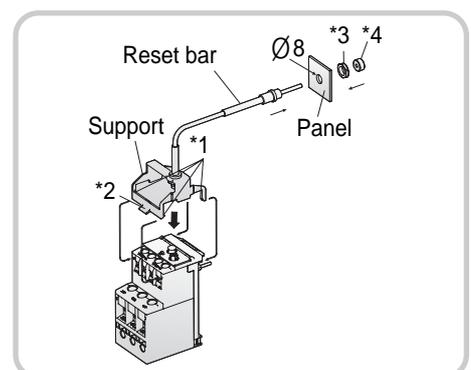
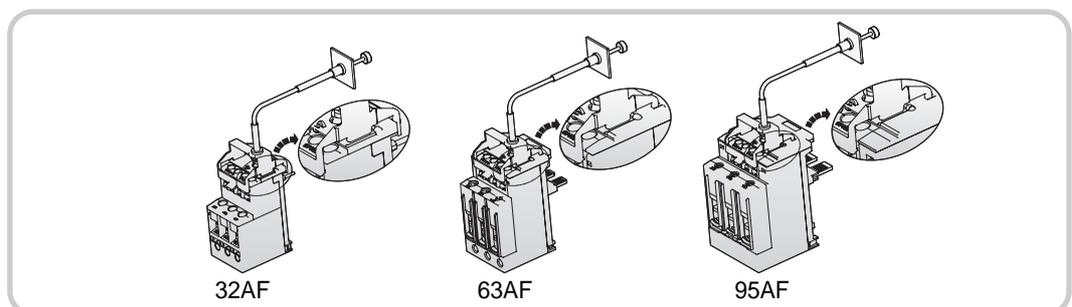
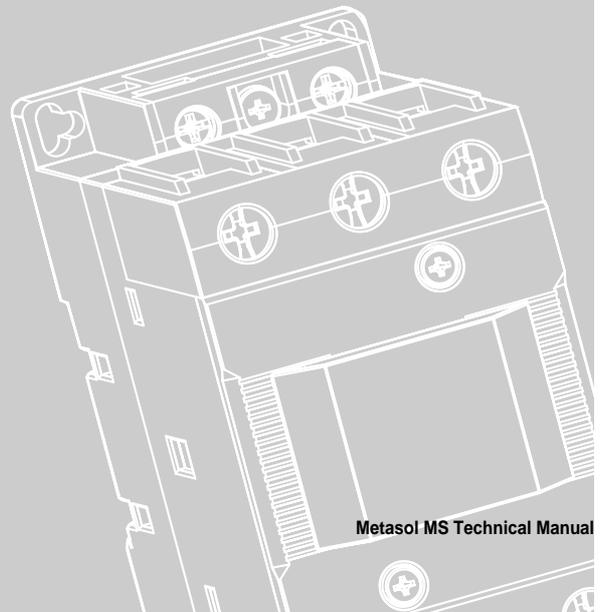

Fig. 30. Approaching reset device installation



G Maintenance and Inspection

1. Type of Maintenance and Checklist 131
2. Faults Caused by Abnormal Operational 132
3. The Cause of Fault and Prevention 139



Maintenance Inspection Management

1. Types of Maintenance and Checklist



Because there is a danger of electric shock during maintenance and inspection, it should only be done by an expert. Be sure to check there is no current flowing on the line by breaking the main circuit breaker before any maintenance and inspection.

1. Everyday Inspection

- 1) Please perform everyday inspection according to the checklist of inspection. If there is a strange sound, strange smell, damage etc. without opening or separating the door or cover.
- 2) If you find anything strange, you need to check strange spot and level by opening a door of metal enclosed switch gear etc.
- 3) Except when the strange matter goes right away before it causes malfunction, please record it and use it for periodical inspection or temporary close inspection.

2. Periodical Inspection

- 1) Under whole power interruption and non voltage condition, please inspect from outside with the naked eye without separating inside if there is anything strange or not by the inspection checklist.
- 2) If you inspect without bus power interruption, please be careful about safety checking.

3. Close Inspection (Temporary Inspection)

Please do the close inspection if it is needed from everyday and periodical inspection or if there is any fault.

4. Maintenance Inspection Checklist

Magnetic switch, protective relay

Type	Check list		Symptoms to check for		Remark	Result
Everyday inspection	Abnormal sound	Hear	Abnormal	Abnormal sound(by abnormal electromagnet, damage etc.)	Switchboard (total quantity)	
	Abnormal smell	Smell	Abnormal	Abnormal smell		
	Cover	Sight	Dirty	Water, oil or dust		
Periodical inspection every six months	Coil	Sight	Color change	Color change	Total quantity	
	Assembly screw	Sight	Loosening	Loose screw	Total quantity	
	Metal unit	Sight	Rust and corrosion	Rust and corrosion	Total quantity	
	Moving parts movement	man/auto	Faulty operation	Smoothly operating moving parts (manually/automatically)	Total quantity	
	Magnetic unit	Abnormal sound	Abnormal sound	Abnormal sound in electromagnet unit	Total quantity	
Close inspection	endurance function aging	Test (tested by our company)	Contact point damage	(1) Contact resistance measurement-contact resistance abnormality		
			Mechanical wear	(2) Operating test-operating voltage abnormality		
			Switching function decrease	(3) Coil characteristic test-resistance, current value of abnormality	Sampling	
			Contact point wear	(4) Over-trouble measure-within permitted amount		
			Contact operation	(5) Contact reliability test-within permitted amount	Sampling	
			endurance	(6) Coil endurance test(high temperature current flow, surge test)	Sampling	

2. Faults Caused by Abnormal Operational

Operational method		Fault mode	Steps to fault	Cause
1	Voltage applied to coil			
1-1	Voltage is higher than the rated value (about 110%)	<p>Coil burnout</p> <p>Opening impossible</p> <p>Electric opening and closing durability decrease</p> <p>Mechanical opening and closing durability decrease</p> <p>Mechanical part damage</p>	<ul style="list-style-type: none"> • If applied voltage is big, the temperature of coil will rise because of power loss increase by excitation current. The durability of coil against heat is influenced by aging insulation coating and if coil temperature goes up 6~10°C, durability decreases in half. With this result, coil heat insulating durability decrease a lot more than normal operating condition. For example, if applied voltage is 5% higher, then coil heat insulating durability will decrease in 50%. • Because bobbin is transformed, hardened and cracked with no elastic force by heat, it causes burn out of coil. • The coil temperature also influences on bobbin, it causes burn out with gradual heat and depending on core structure(structure as moving core inside of bobbin), there is a case that bobbin shrinks and being locked. • By the buffer below the fixed core is transformed by heat gradually, it is hardened and loses impact absorption capability. Then the vibration is increased and it causes decrease of electric switching durability. • If the voltage applied to coil is bigger than the rated value, slow absorption force energy increases. Then mechanical switching durability is reduced in inverse proportion to applied voltage by a multiple of 4~5² which was found from testing. Also damage of normal wear etc. occurs from mechanical parts abnormal stress. For example, if voltage is increased 10% mechanical durability decreases about 50%. 	<ul style="list-style-type: none"> • Use big capacity operating trans under almost no load conditions • Incorrect tap connection of operating trans • Incorrect selection of coil rating for voltage and/or frequency • Power voltage change

G

Maintenance Inspection Management

2. Faults Caused by Abnormal Operational

Operational method		Fault mode	Steps to fault	Cause
1-2	In case of higher than rated value (200% of designated value)	Coil burnout Discolored contact point abnormal burnout	<ul style="list-style-type: none"> Coil is burned out after a few hours because abnormal overheating is caused by excessive excitement current when high voltage is substantially permitted above coil rating. Also before reaching coil burnout, contact overheating by arc heating, abnormal burnout are generated because wobbling is increased due to overabsorption force. 	Mis-selection of coil
1-3	Large voltage decrease	1) Holder insulation part supporting contact region is heating deformed (soot) by arc ↓ 2) Escaping of contact welding point ↓ 3) Contact elimination (there is melting and fusion in this stage.) ↓ 4) Melting damage of contact terminal ↓ 5) Mutual disconnection by procedure of insulation part carbonization	<ul style="list-style-type: none"> The driving current of electrical motor flows by insertion of magnetic contactor, when the voltage decrease of circuit decreases under the large maintenance voltage, magnetic contactor repeat insertion-voltage-decrease-open-voltage-recovery-reinsertion-voltage-decrease then it continues frequent chattering with 10~20times/second. In this case because of repeating insertion cutoff of current at high-frequency, the stored amount is much more than the emittance amount of arc heating, and the contact reaches high temperature causing the welding part to melt for a short time, it processes to a disconnection through failure mode on the left hand side. 	<ul style="list-style-type: none"> Shortage of power capacity Improper driving method (simultaneous driving with multiple motor etc.) Too long wire distribution. Too thin wire gauge.

Operational method		Fault mode	Steps to fault	Cause
1-4	Lower than rated value	It sometimes reaches melting and fusion with a driving current without contact pressure or the breakdown such as 1-3.	<ul style="list-style-type: none"> When the permitted voltage to coil is low initially (voltage is permitted from less than 85% of rated voltage to the range of machine core can be moved) or the permitted voltage of 2 coil decreases(voltage is permitted from less than 85% of rated voltage to the range of machine core can be moved) by the rush current (8~15 times of excitement current), core generates lack of absorption force around the contact and it makes chattering such as 1-3 by repeating insertion-contact connection. In this case it reaches contact melting and fusion or disconnection such as 1-3 	Mis-selection of control trans(lack of capacity)
1-5	Substantially lower than rated value	Coil burnout	<ul style="list-style-type: none"> When the permitted voltage to the coil is initially decreased(the voltage is permitted, which cannot move moving core), there is a rush current to the coil, but it cannot be inserted, so coil is abnormal heated. In this condition it reaches coil burnout in a few hours. 	Mis-selection of coil
2	In case of high on/off frequency	Breakdown is generated such as in 1-3.	<ul style="list-style-type: none"> Contact temperature of main circuit is getting the influence of arc heating by load current on/off and joule heating from current flow. It causes arc heating when it is on/off at the frequency more than the capacity of the magnetic contactor. 	Mis-selection of magnetic contactor

G

Maintenance Inspection Management

2. Faults Caused by Abnormal Usage

Operational method		Fault mode	Steps to fault	Cause
3	Inching antiphase braking	Failure like 1-3 will occur	<ul style="list-style-type: none"> Depending on the ratio of operating inching and plugging control during opening and closing recovery, contact point's abnormal heating will be caused by arc heat. 	Wrong selection of magnetic switch
4	Rapid phase alteration	Contact Melting and Fusion Contact Burnout Shortcircuit between phases	<ul style="list-style-type: none"> Short circuit between phases by rapid phase transfer on motor's reverse and Y-Δ operation 	<ul style="list-style-type: none"> Unstable operating circuit - Electron interlock -Shortage of alteration time
5	Operation circuit causing chattering	Failure like 1-3 will occur	<ul style="list-style-type: none"> If there is chattering on the operation circuit's contact point by impact, vibration, etc. from outside, magnetic contactor's voltage applied to coil keeps flowing even during chattering. Contact point will then repeat closing-breaking-closing and abnormal heating. Wearing out, melting and fusion will occur. 	<ul style="list-style-type: none"> With installing relay close by magnetic contactor, contact point of relay causes chattering by closing collision of magnetic contactor. The contact point of pressure S/W and Limit S/W is doing intermittent operation under unstable operating condition. Because of control board structure or wrong installation, contact point of magnetic contactor causes chattering.

Operational method		Fault mode	Steps to fault	Cause
6	Much vibration impact	Contact point melting and fusion Contact point burnout Short circuit between phases	<ul style="list-style-type: none"> Short circuit from magnetic contactor's concurrent closing by vibration or impact from outside 	<ul style="list-style-type: none"> Mechanical interlock unstable -Operation faulty -Not using
		Terminal unit burnout Short circuit between phases	<ul style="list-style-type: none"> Loosen main circuit terminal screw, there can be heating or burn out on the loose part so in this case maybe arc short circuit will occur. 	Main circuit terminal installation shortage of torque
7	Installation type			
7-1	Parallel installation	Mechanical durability decrease Electrical durability decrease opening impossible	<ul style="list-style-type: none"> Because acceleration of gravity occurs in the direction of core's moving, closing speed of moving core becomes faster and on the core unit and structure unit would have big impulsive force. Mechanical opening and closing durability will be reduced. Closing speed of moving contact point gets faster with same reason, bounce becomes longer and wear of contact point also is increased. If it's not fixed on parallel installation, damage or loss as below can occur. <ul style="list-style-type: none"> -Because vibrating screen which absorbs fixed core's impact transforms, contact bounce continues abnormally. As a result, contact point opens and closes starting current, abnormal wear, melting and fusion will occur. 	Incorrect installation method

G

Maintenance Inspection Management

2. Faults Caused by Abnormal Usage

Operational method		Fault mode	Steps to fault	Cause
7-1	Parallel installation	Mechanical durability decrease Electrical durability decrease opening impossible	<p>-Because magnetic contactor moves at any direction during opening and closing, charging unit contacts other accessories and it causes short circuit fault or overheating of connection wire by vibration.</p> <ul style="list-style-type: none"> • By the weight of moving units, there is a chance of impossibility of opening and closing. 	<ul style="list-style-type: none"> • Improper installation
7-2	Ceiling installation	Operation faulty Contact point detached Contact point melting and fusion	<ul style="list-style-type: none"> • Because moving core acts reverse direction of acceleration of gravity, operation voltage increases. As a result, if the voltage applied to coil decreases, it can cause (within rating value) impossibility of opening and closing, chattering around contacting points by shortage of absorption force (similar condition as 1-4), or big damage on contact points. 	<ul style="list-style-type: none"> • Improper installation
7-3	Crossway installation	Mechanical switching resistance decrease Device damage Operatoin impossibility	<ul style="list-style-type: none"> • Because moving units and sliding position change during opening and closing with influence of gravity, moving units operate opening and closing differently from normal condition. As a result, it causes abnormal sliding worn out and mechanical opening and closing durability decreases. Also interference of accessories or connecting pin, etc. occurs and causes device's damage or impossibility of operation. 	<ul style="list-style-type: none"> • Improper installation

Operational method		Fault mode	Steps to fault	Cause
8	Artificial mistake	<ul style="list-style-type: none"> • Unexpected operation • Melting and fusion • Short circuit 	<ul style="list-style-type: none"> • If moving units are to be operated intentionally or pressed by accident from outside, magnetic contactor will be operated suddenly and this will cause harm to humans or load (machinery unit) damage. And because starting current of motor flows on magnetic contactor without enough contact point's contacting pressure, it is likely to have melting and fusion on contact point. • When the moving unit of reversible magnetic contactor is to be pressed by accident, two magnetic contactor becomes tripped at the same time and it can cause a short circuit. • After separating and inspecting arc extinguish chamber, if you forget to assemble it back when you install or intentionally separate magnetic contactor while arc extinguish chamber is separated, short circuit between phases will be occurred by arc during opening and closing. 	<ul style="list-style-type: none"> • Moving unit was operated by artificial mistake. • After inspection, improper installation

G

Maintenance Inspection Management

3. The Cause of Fault and Prevention

Fault	Conditions	Cause	Prevention		
No closing	Chattering sound and no closing	Rated voltage of coil is not correct.	Choose correct rating again.		
		Terminal voltage is low. (below 85%)	Adjust to designated voltage.		
		Voltage drop is big. (shortage of power and wiring capacity)	Make power capacity higher and wiring thicker.		
		There is foreign substance in moving units.	Disassemble and remove it.		
		Coil burnout	Exchange coil.		
		It's damaged.	Exchange main body.		
	No sound (It does not operate.)	Wiring faulty	Repair faulty spot.		
		Operating switch malfunction	Exchange switch.		
Fuse is broken.		Exchange fuse.			
Operating coil disconnection and operating circuit's short circuit		Exchange coil.			
No opening and closing (no returning)	Coil's excitation is not broken.	Coil voltage is flowing.	Check the circuit and adjust.		
		Capacity between wires of long distance wiring	Direct current operation type		
		Induced voltage from different wire	Disconnect from other wire.		
		Operating switch malfunction (melting, fusion and damage)	Check capacity properly and exchange. Exchange the product.		
	It's not excited.	Contact point is melted and fused.	Exchange contact point and check the cause.		
		Oil or dust is attached on core surface.	Disassemble and handle it. Prevent absorption.		
		Dew on core surface	Make the temperature difference small. Disassemble and handle it.		
		It's absorbed by residual current.	Exchange main body because of wornout.		
		There is foreign substance in moving units.	Disassemble and handle it.		
		The main body is transformed by heat or bent installation	Exchange main body.		
		Coil burnout	Burnout in a short time	It's damaged.	Exchange main body.
				Wrong selection of coil rated voltage	Change to correct rating.
Applied voltage is wrong(too high).	Coil exchange, change voltage.				
Absorption impossibility from low operating voltage	Coil exchange, change voltage.				

Fault	Conditions	Cause	Prevention
Coil burnout	It's burnt out after a short period.	Occasionally absorption faulty is occurred. voltage(below 95%, etc.)	Coil exchange and check the cause.
		Burnout by environmental heat.	Coil exchange and chck the cause of heating.
		Applied voltage is too high.	Coil exchange and voltage adjustment
		Switchboard temperature is too high.(above 55℃)	Coil exchange, coil temperature below140℃ (temperature increase below100℃)
Contact point melting and fusion	MCCB breaking or fuse is disconnected.	Load side short circuit insulation decrease, wiring faulty, wrong handling(reversible type or during operational concurrent closing)	Check the cause and adjust. If the main body does not have any problem, exchange contact point but if there is, exchange the main body.
		There was light melting and fusion during operational.	Chattering
	Frequency of switching is too high.		Lower the frequency and increase capacity
	Semi absorption condition by voltage decrease		Remove the cause of voltage drop.
	Electrical endurance		If the main body does not have any problem, exchange contact point
	Load is too big.	Exchange contactor with proper capacity.	
Contact point abnormal wear	Arc is big during opening and closing.	Load is too big.	Exchange with bigger capacity one.
		Frequency of switching is too high.	Choose the right capacity for frequency.
		During closing, big vibration	Check the cause and adjust.
	Contact point's welded part is excluded.	Contact point chattering is big.	Check the cause and adjust.
		Frequency of switching is too high.	Lower the frequency or exchange with bigger capacity.
	Fast wear	Oil, etc. are attached to contact point surface.	Repair and prevent adhesion.
		Cossive gas, etc.	Improve installation spot.
		Capacity is low.	Exchange with proper capacity.
	Coil burnout	It happens sometimes.	A lot of dust
Oxidized contact point surface			Clean contact point surface and to the inhibition of oxidization/Exchange
Foreign substance on contact point surface			Repair contact point.
Foreign substance in moving unit			Disassemble and repair.
It happens continuously.		Oil dust is attached on contact point surface.	Disassemble, repair, and prevent adhesion.
		Carbonized contact point surface	Exchange contact point, enclosed type and installation spot exchange
		Low voltage and current	If possible, use over 110V 50mA.
		Foreign substance on contact point surface	Disassemble and repair.
		Contact point is detached.	Contact point repair, Remove detachment cause, prevent adhesion processing
		Structure unit is damaged.	Exchange main body.

G

Maintenance Inspection Management

3. The Cause of Fault and Prevention

Fault	Conditions	Cause	Prevention
Terminal burnout	Terminal and wire burnout	Terminal screw is twisted.	Exchange main body.
		Torque shortage of terminal screw	Adjust screw tightening torque.
		Loose screw by vibration and impact	Prevent vibration and impact.
		Wire is too thin.	Exchange wire and main body.
		Contact point melting and fusion, wear(endurance)	Exchange main body.
Chattering	Chattering occasionally	Foreign substance between core	Disassemble and repair.
		Small amount of rust on core	Disassemble and clean core surface.
		Core wornout	Exchange main body.
		Power voltage is low.	Check the cause and adjust.
		High corrosive gas and humidity	Prevent penetration from outside.
	Frequent chattering	Foreign substance between core	Disassemble and repair.
		Core is rusted.	Disassemble and clean core surface.
		S-coil short circuit(endurance)	Exchange main body.
		Improper installation, installation surface is twisted.	AD just for proper installation.
		Incorrect coil voltage (low voltage)	Exchange with proper coil.
		Core wornout	Exchange main body.
		During switchboard installation, resonance	Change installation structure.
		Reversible mechanical interlock	Mechanical interlock readjustment
Chattering	It occurs on main circuit part(abnormal sound)	Large current is flowing.	Measure current and remove the cause.
		Wires inside of panel are seperated by each strand	Wiring through same hole for input and output wires
TOR is operated.	It occurs frequently.	Load is too big.	Use proper load.
		Switching frequency is too high.	Reselect suitable for switching frequency.
		Vibration impact is big during operational.	Change installation method and place.
		Incorrect regulating current of TOR	Choose proper regulating current.
		Improper selection of TOR current capacity	Exchange with proper current capacity.
	It occurs during starring.	Long starting time(over 10 sec.)	Reselect TOR.
		Starting current is big.	Install saturation reactor.
		Incorrect application(Y- Δ , pole conversion, etc.)	Reselect properly.
		High surrounding temperature	Temperature adjustment or installation place change.
		Different load	Adjust load or rechoose motor.



Fault	Conditions	Cause	Prevention
Inactive TOR	-	Incorrect TOR capacity	Reselect properly.
		Incorrect TOR regulating current setting	Select properly.
		TOR damage	Exchange TOR.
		Special structure of motor	Choose special typeTOR.
		Reset bar was pressed.	Remove obstacles.
		Reset is repeated within short time.	Recheck motor capacity.
		Contact point melting and fusion(short circuit)	Exchange TOR.
		Malfunction of magnetic contactor	Exchange magnetic contactor.
		Wiring faulty	Adjust cause of faulty.
	Heater fusing	There was short circuit current.	TOR exchange, improve protection cooperation.
Wiring faulty		TOR exchange, adjust cause of faulty.	
TOR is not reset.	-	Resetting too fast	Cooling and reset.
		Contact faulty of contact point	Exchange TOR .
		Wiring faulty	Check the cause of faulty and adjust.



H. Selection and Application

1. Selection	144
2. Application	152

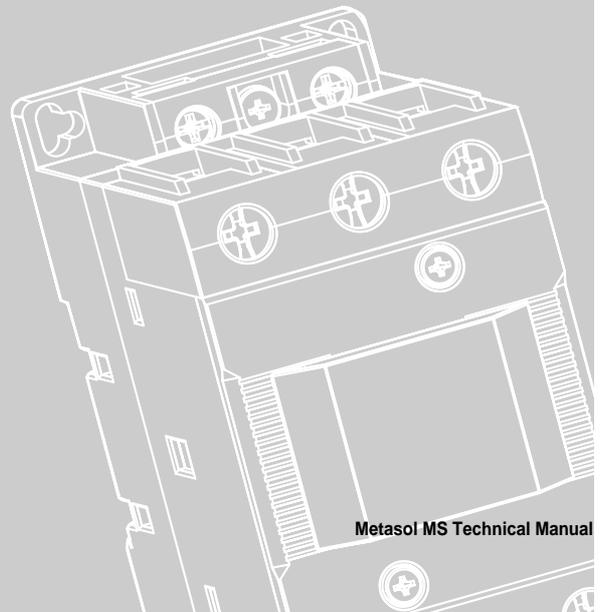

Selection and Application

1. Selection

1.1 General Selection

- | | |
|--|---|
| ■ Consideration of operational location | An assembled type magnetic switch has a protective structure but closed type is recommended in the case of an indoor facility, because installation place, and operational environment need to be considered. Anti-vibration type is good for dusty places, anti-corrosion type is good for chemical plants, a switch is good for a general device plant, as it's important to be careful to avoid oil penetration inside of the control unit. Holes should be considered, because this is a cause of connection fault, contactor's contact abnormal wear, and mis-operation. |
| ■ Selection of rated capacity | Rated capacity is selected by applied load type, voltage, frequency, capacity. The capacity of the magnetic switch is selected by output power, voltage, frequency, entire load current of electrical motor in the case of motor load, and control circuit is selected by the coil which has aligned with operational voltage, frequency, and also overload thermal relay for motor protection is selected by the standard of the entire load current. |
| ■ Consideration of operational location | <p>Magnetic switch is regulated in KSC or IEC with the class depending on close circuit or breaking capacity, type by switching frequency and each number endurance. For example, A4 class, number 1, type 1 indicates 10 times breaking current, 1200 cycles per hour switching frequency, electrical 500,000 cycles and mechanical 5,000,000 cycles. Normally the performance is determined under general driving conditions, but endurance changes drastically by inching movement or negative phase suspension of switching frequency, motor driving in real operational conditions, therefore thorough investigation such as the following is necessary.</p> <ol style="list-style-type: none">1. Switching frequency per hour, maximum switching frequency2. Input current, breaking current3. Implementation of inching, negative phase suspension4. Amount of time required for replacement5. Circuit composition |
| ■ Consideration of circuit composition | Electrical motor overload should be protected as long as using switch, but using breaker for circuit protection wiring is necessary when there is no ability to break the short circuit or heating element of overload thermal relay is possible for fusing. Especially protection cooperation should be considered when selecting the rating. |

1.2 Basic Performance of the Switch

There are four basic element functions shown in the table below in the switch of electrical circuits, the contents in the following table and economical efficiency need to be examined at the same time when the switch is being selected.

Item	Function	Product rated performance (element determining performance)	Important examination during selection of type
Switching performance	<ul style="list-style-type: none"> Closed circuit function Breaking function Insulation voltage 	<ul style="list-style-type: none"> Closed circuit current Breaking Current (Here current capacity is electric energy according to voltage X current X power factor.) 	<ul style="list-style-type: none"> Circuit current ≤ closed circuit breaking capacity
Current flow performance	<ul style="list-style-type: none"> Continuous Current Flow Short-term current flow 	<ul style="list-style-type: none"> Flowing current(Joule heat) Over current limit quantity (Fleming's left-hand law) 	<ul style="list-style-type: none"> Load current ≤ Conventional free air thermal current (Ith) inrush current or starting Current ≤ Over current limit quantity
Switching durability	<ul style="list-style-type: none"> Mechanical endurance Electrical endurance 	<ul style="list-style-type: none"> Control Voltage, type (AC/DC), load capacity Switching voltage, current, power factor Switching frequency Operational rate Number of switching 	<ul style="list-style-type: none"> Demanding electrical durability ≤ electrical durability Repetitive switching frequency ≤ switching frequency Switching voltage ≤ rated operational voltage Load Load current ≤ rated operational current Demanding electrical durability ≤ electrical durability
Overcurrent detection		<ul style="list-style-type: none"> Over current detection element and performance characteristic (current and time characteristic) 	<ul style="list-style-type: none"> Load rated current = setting current of overload protection device (load current is selected within rated current range of detection element)

Note1) Arc Energy becomes the smallest when the current and voltage are in the same phase.

Note 2) Energy quantity when switching varies alot, depends on the

$$\text{value of the power factor} \left(\cos\phi = \frac{R}{\sqrt{R^2 + X^2}} \right)$$

Note 3) Joule's law is explained in the following formula:

$$H = 0.24 \times I^2 \times R \times t (\text{cal})$$

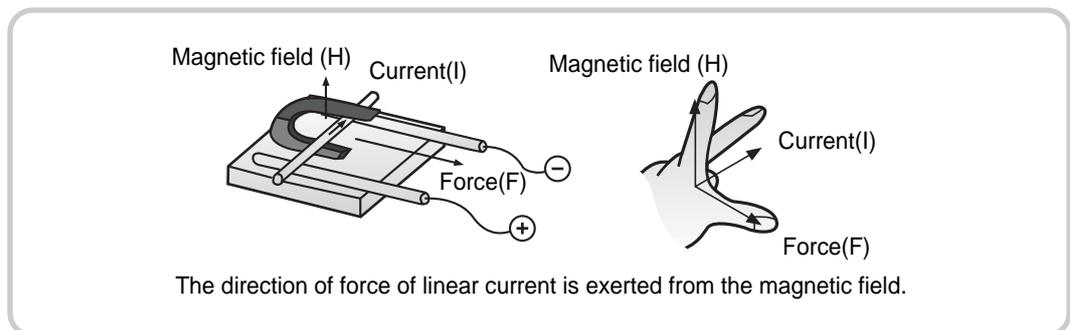

Fig. 31. Fleming's left hand law

The force exerted on the conductor varies depends on the amount of current and magnetic flux. Moreover, the amount is proportional to the amount of current. But, the force is not exerted when current and direction of magnetic field are parallel.

Selection and Application

1. Selection

1.3 Selection Process

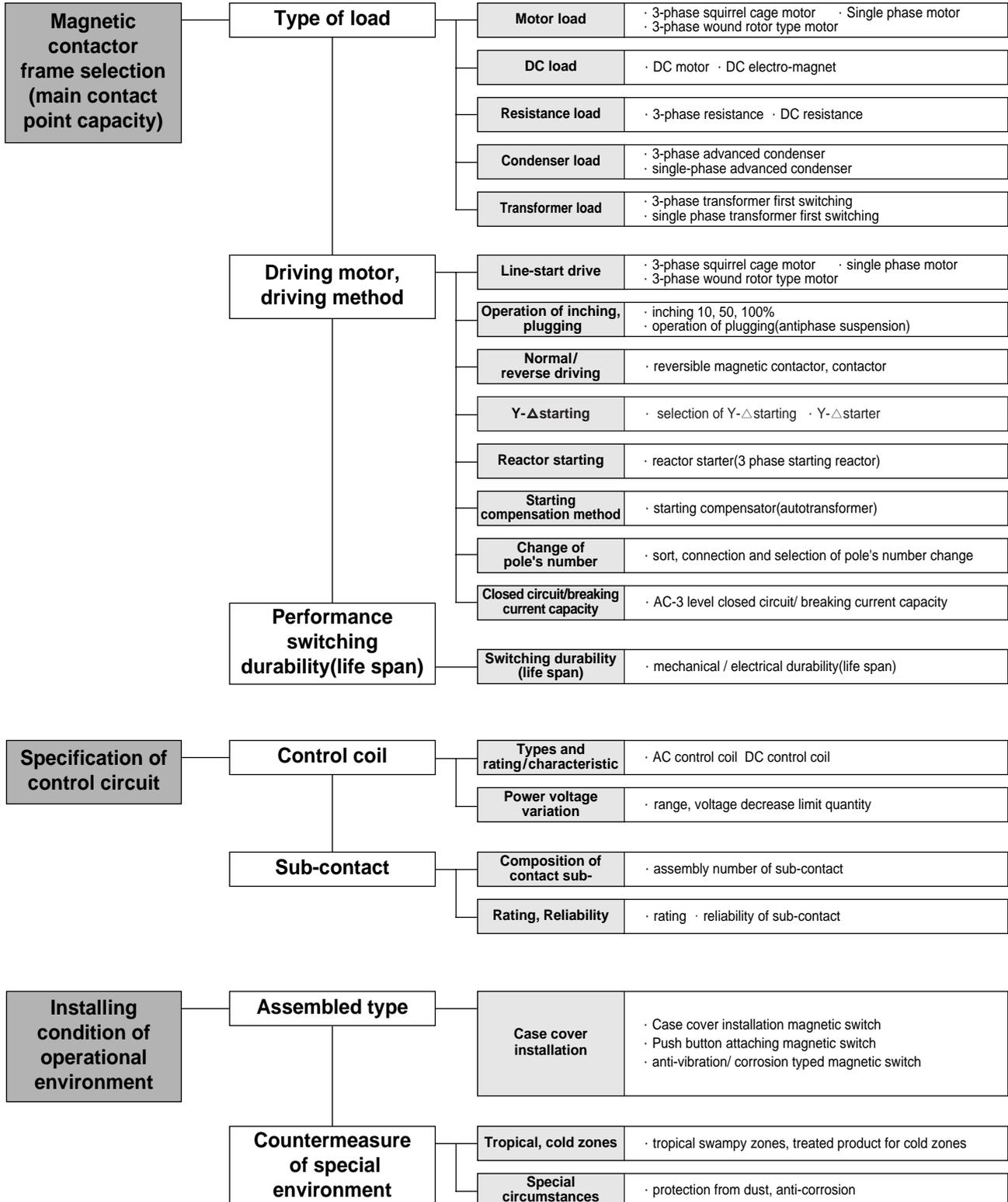

H

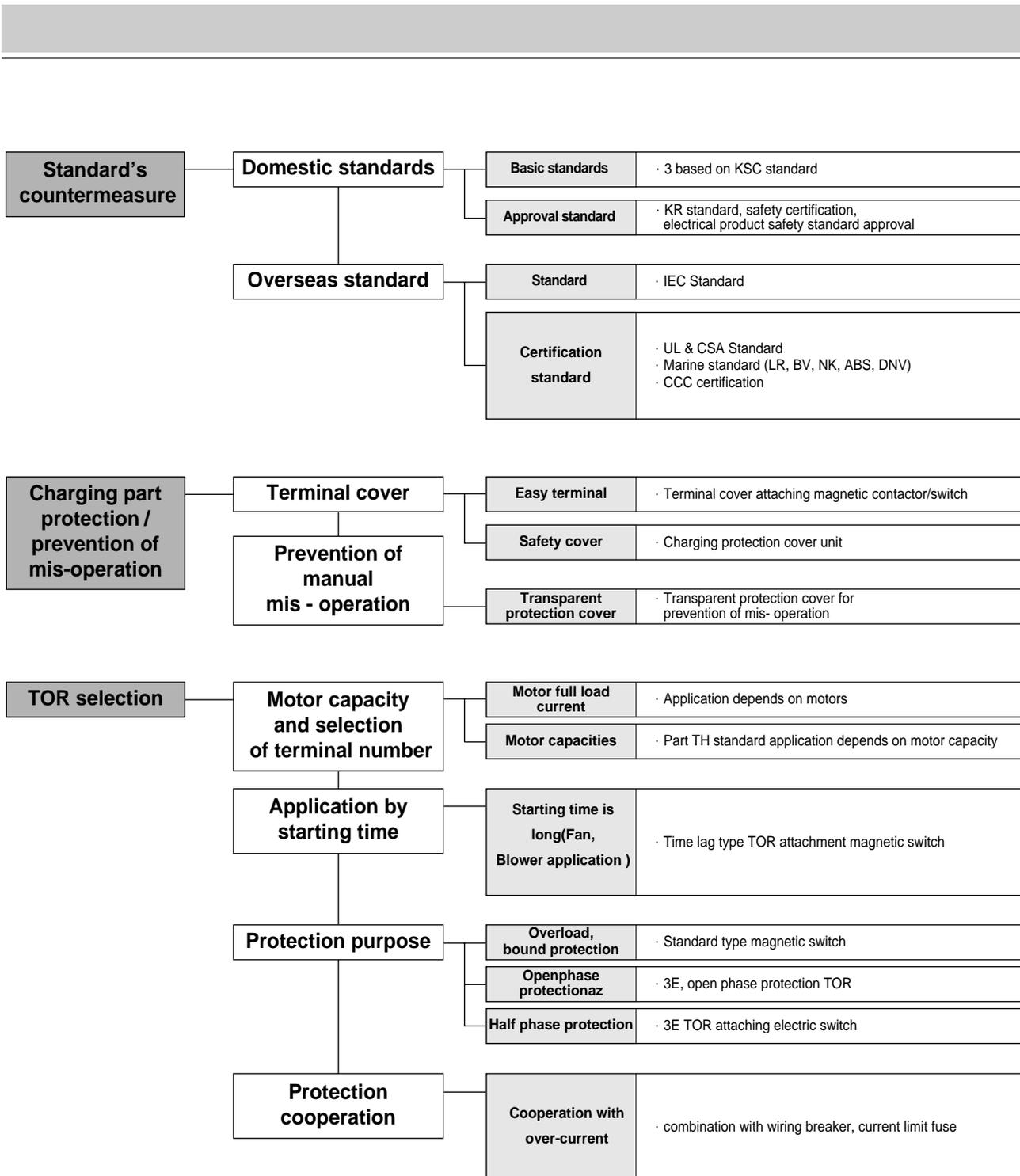

Selection and Application

1. Selection

1.4 Terminology Definitions

■ Circuit

1. Main circuit

Current flowing part of magnetic contactor which can be inserted into circuit, it is a circuit connected to electric machines which convert electricity into mechanical force

- Motor (Electrical energy → Mechanical Energy)
- (Electrical energy → Thermal Energy)
- Circuit connected to electric lamp (Electrial energy → optical energy)

2. Control circuit

It is a circuit sending electrical signals to the coil in order to activate magnetic switch, contactor solenoid which opens the main circuit of magnetic contactor's conductor part for controlling magnetic contactor's insertion or breaking action.

3. Sub-circuit

Every conductor part of magnetic contactor inserted into main circuit and other circuit's from magnetic contactor's control circuit.

■ Overload thermal relay tripping class

Tripping class of IEC 947-4-1 is defined with 10A, 10, 20 and 30. Types 10A, 10 etc. are suitable for the maximum tripping time for insertion current of 720% of setting current. Moreover, the standard of each class indicate the basic tripping time of 150% of the setting current, set the condition of no tripping at 105% of setting current. All this data is summarized in the following table.

IEC947-4-1 citation

Tripping class	10A	10	20	30
setting current' s 1.5 times (Hot state) (s)	120	240	480	720
setting current' s 7.2 times(cold state) (s)	2-10	4-10	6-20	9-30
setting current' s 1.05 times	No tripping			

■ Insulation class

This characterizes the application of device depends on surrounding temperature and operating conditions. The equipment has an alternative insulation voltage depending on insulation class A,B,C,or D depending on the given space and creeping distance, class C is mostly suitable for industrial applications.

■ Equipment protection cooperation during short circuit.

This is a priority of thermal overload relay of SCPD and negative contactor such as fuse, breaker which have high breaking capacity, or other fuse.

- IEC publication 947-4-1 defines Type "1" and "2"

1) Type "1" cooperation

Magnetic contactor or switch is not dangerous to humans or installer during short circuit, it is required not to operate without repairs or part replacement

2) Type "2" cooperation

Magnetic contactor or switch is not dangerous to humans or installer with short circuit, it is required to operate later. Contact is allowed for a little amount of melting and fusion. Manufacturer should make some proper preparations related to maintenance of equipment in this case.

- **Rated operational current(Ie)** | Rated operational current is the usable current value from the manufacturer. This current is defined by rated operational voltage(Ue), rated operational frequency, application range of standard or rating duty. The current which is sending rated voltage to motor resistance is called the entire load current, but the maximum entire load current encompassing breaking closed circuit capacity, switching frequency, endurance is called rated operational current.
- **Electrical motor's case (case of Metasol series)**
The AC3 class current shows rated operational current at 1800 switching cycles/hour, 2,000,000~2,500,000 cycles electrical endurance an
- **Conventional free air thermal current(Ith)** | Contactor can last for 8 hours without any temperature increase of partial component at the condition of flowing current in this current. Rated flow current is a maximum current value which can flow continuously for more than 8 hours and it is less than increased temperature decided by the standard, it can be used up to this rated flow current in case of resistance load in Metasol series. Rated flow current Ith, application class of resistance load is indicated with AC1 class. Therefore Metasol series indicates AC1=Ith A.
- **Allowed short-term rating** | This current doesn't let inserted contactor generate dangerous overheating, can be maintained for a short term after a no load period.
- **Rated operational voltage(Ue)** | Rated operational voltage can determine the contactor operational with rated operational current, and determine test and application ranges. Operational voltage is indicated by two phase voltage in a three phase circuit, it is less than or equal to rated insulation voltage Ui.
- **Rated insulation voltage(Ui)** | Rated insulation voltage decide on of insulation equipment and leakage route and insulation distance. and related with intensity examination. The voltage is allowed at the wiring distributed flow current part such as magnetic switch, contactor, but it is regulated that the resistance(insulation resistance) of this current flowing part is low, or the minimum distance that insulation is not destroyed between current flowing part at low voltage, and the voltage(withstanding voltage) that the insulation is not destroyed. This insulation distance and withstanding voltage is different from actually used voltage(rated endurance voltage). Therefore, rated insulation voltage \geq rated endurance voltage.
- **Rated impulse withstand (Uimp)** | In test conditions, it is the peak impact voltage which can endure equipment becoming defective can be prevented and impulse voltage peak value.
- **Rated circuit voltage(Uc)** | It is a basic control circuit of operation characteristic, this value is given as a rated value of voltage in sine wave form in an AC circuit application.
(Higher harmonic distortion : less than 5%)
- **Rated operational capacity(kW)** | The rated capacity at the rated operational voltage when switching of the contactor is possible (kW)
1) Rated output power(kW) of the maximum application motor about the rated operational voltage in case of electrical motor.
2) Entire load capacity(kW) of the maximum application resistance load about rated operational voltage in case of resistance load.
- **Cycle time** | It is the sum of no current time and current flow time during a given cycle.

Selection and Application

1. Selection

1.5 Vocabulary Definitions

- Switching durability** | It is the limit of switching cycles for which magnetic contactor can be used without any problems under regular conditions.
- Electrical durability** | It is the average durability by electrical wear in the case of switching with the regulated conditions under load. It is the number of load operations that the contactor can switch, and it is different depending on the application range.
- Mechanical durability** | It is the average durability by electrical wear in the case of switching with the regulated conditions under no load. It is the number of no flow current operations that the contactor can switch.
- Making and breaking** | It is the capacity that breaking and making is possible under regulated conditions. It is the value that the contactor can break and insert in the voltage the root mean square of current according to a given application range and indicated conditions in the standard.
- Load factor** | No load operation time ratio of the entire cycle time x 100. Ratio between current flow time(t) and cycle continuance(T).
- $$\text{load factor}(m) = \frac{\text{cycle continuance time}(T)}{\text{current flow time}(t)} \times 100$$
- Cycle continuance : time at current flow cycle + zero current
- Operational ratio (%)** | It has a regular or irregular cycle for the short-term indicating the degree of device operational, the total sum of operational time within a certain time is indicated with a percentage and it is called %ED.
- $$\text{operational ratio} (\%) = \frac{\text{total sum of current flow time for one hour (s)}}{3600} \times 100$$
- total sum of current flow time for one hour is indicated by the percentage.
- Switching frequency** | Number of switching cycles per hour.
- Plugging** | Separate the driving motor rotating in one direction from the power, shift and connect the two phase wire connected to motor, then the motor will rapidly stop because a rotating force in the opposite direction about the rotating direction force is generated.
- Inching** | For miniscule variations of the electrical motor, excite the motor for a short time then perform the opening action more than one time. By frequently repeating motor's driving and stopping, it breaks driving current before motor reaches full speed.

<p>■ Limit of coil operation</p>	<p>It is expressed with times of normal control circuit voltage (Uc) with a higher or lower limit.</p>
<p>■ Installation location</p>	<p>It follows the direction of the manufacturer. Limit of specified installation location should be considered.</p>
<p>■ Intermittent duty</p>	<p>The duty of the contactor is continuously inserted for a very short time to reach thermal equilibrium of contactor.</p>
<p>■ Phase impedance</p>	<p>Impedance of one phase is a sum of every circuit part between the input terminal and the output terminal. This impedance consists of resistance parts(R) and inductive parts($X=L\omega$). Therefore the entire impedance is different depending on frequency, normally it is given at about 60Hz. This average value is given about the phase at the rated operation current.</p>
<p>■ Time</p>	<ol style="list-style-type: none"> 1. Time constant the ratio of inductance about resistance ($L/R = \text{mH}/\Omega = \text{ms}$) 2. Short-time withstanding current the current of which magnetic contactor can resist at the inserted location of specific condition for short-term. 3. Minimum switching time This is the closed circuit or breaking order time for the perfect closing circuit or breaking by magnetic contactor. 4. Closing time time interval when start and contact of closing operation separates from every phase 5. Opening time time interval when starting moment and arc contact of opening operation separates from every phase
<p>■ Impact resistance</p>	<p>Is a requirement for installation in cars, crane drives, marine and plug-in devices. The location of magnetic contactor shouldn't be altered with acceptable value "g", TOR shouldn't be tripped.</p>
<p>■ Resistance to vibration</p>	<p>It is a requirement for cars, boats and other shipping transportation. The equipment should be operated continuously with a specific vibration altitude and frequency value.</p>
<p>■ Indication of RC and TC</p>	<p>It is current capacity indication method of TOR, operation current is indicated by TC(tripping current), indicating load rated current value is RC(rating current). Both sides relation is 1.25 : 1, recently every company applies RC.</p>

Selection and Application

2. Application

2.1 Application Categories

Contactors, contactor relays, and thermal overload relays are regulated by IEC 947-1, 947-4-1 and 947-5-1, the duty of contactor related operational voltage, current application range and thermal overload relay's duty is regulated by international standards, the duty of a contactor is characterized by rated operational voltage and current application range.

1. Contactor application categories by IEC 947-4-1

AC	AC-1	Load, resistance furnace with non-inducing or minute inducing characteristic
	AC-2	Drive and stop of wound-rotor type motor
	AC-3	Stop during the driving, starting squirrel-cage type motor
	AC-4	Squirrel-cage type motor: starting, plugging, inching
	AC-5a	Control device switching such as discharging
	AC-5b	Incandescent lamp switching
	AC-6a	Transformer switching
	AC-6b	Condenser bank switching
	AC-7a	Low inducing load about home appliances and similar applications
	AC-7b	Household operational motor load
	AC-8a	Manual reset type overload closed type freezing compressor motor
AC-8b	Automatic reset type overload closed type freezing compressor motor	
DC	DC-1	Load, resistance furnace of non-inducing, minute inducing characteristic
	DC-3	Starting of shunt motor, plugging, inching, dynamic suspension
	DC-5	Starting of series motor, plugging, inching, dynamic suspension
	DC-6	Incandescent lamp switching

2. Contactor relays application categories by IEC 947-5-1

AC	AC-12	Control of suspension load and resistance load with optical coupler in insulation
	AC-13	Control of suspension load which has transformer insulation
	AC-14	Control of minute electric load ($\leq 72VA$)
	AC-15	Control of electromagnetic load ($> 72VA$)
DC	DC-12	Control of suspension load and resistance load which has optical coupler in insulation
	DC-13	Control of DC electromagnet
	DC-14	Control of DC electromagnet which has economical resistance

2.2 Durability(durability) Indication Method by Standard



● Depending on switching frequency and number possible switching number per hour is indicated

Types		#0	#1	#2	#3	#4	#5	#6
Switching freq. (times/hour)		1800	1200	600	300	150	30	6
Operational ratio (%)	AC contactor	15	25	40	60	60	60	60
	DC contactor	25	40	40	40	60	60	60

Note 1) Operational ratio(%) is applied to AC-1, AC-2, AC-3, DC-1, and DC-6. But the operational ratio of AC-4, DC-3 and DC-5 is taken with manufacturers guaranteed value.

Note 2) Switching frequency indicates individual switching per hour.

● Depending on durability type mechanical durability and electrical durability are indicated.

Number	Mechanical durability	Electrical durability
#0	More than 10 million times	More than 1 million times
#1	More than 5 million times	More than 500,000 times
#2	More than 2.5 million times	More than 250,000 times
#3	More than 1 million times	More than 100,000 times
#4	More than 250,000 times	More than 50,000 times
#5	More than 50,000 times	More than 10,000 times
#6	More than 5,000 times	More than 1000 times

Note 1) Durability indicates the number that switching operation is one time.

Note 2) Combination indication per type is indicated by each type when electrical durability, mechanical durability types are different, and it may be omitted with one of them when the types are matched

● Depending on the class of closed circuit and breaking current :

Depending on the class of closed circuit and breaking current :

current value times for which close circuit or breaking is possible about rated operational current indication value are indicated. Circuit conditions (closed circuit and voltage, current, power factor) are determined to evaluate electrical durability, circuit condition(closed circuit and voltage, current, power factor)

Types	Category	Test conditions						Representative application example	
		Making (KSC, IEC)			Breaking (KSC, IEC)				
		I / Ie	U / Ue	cosØ	Ic / Ie	Ur / Ue	cosØ		
AC magnetic contact or	AC-1	1	1	0.95	1	1	0.95	Resistance load switching of non-inducing or minute inducing char.	
	AC-2	2.5	1	0.65	2.5	1	0.65	Starting, stopping wound-rotor type motor	
	AC-3	I ≤ 17A	6	1	0.65	1	0.17	0.65	Starting and stopping Squirrel-cage type motor ^{Note1)}
		17A < I	6	1	0.35	1	0.17	0.35	
	AC-4	I ≤ 17A	6	1	0.65	6	1	0.65	Starting squirrel-cage type motor, anti-phase suspension, inching
		17A < I	6	1	0.35	6	1	0.35	
DC magnetic contact or	DC-1	1	1	1	1	1	1	Resistance load switching of non-inducing or minute inducing characteristic	
	DC-3	2.5	1	2	2.5	1	2	Starting shunt motor, anti-phase suspension, inching, DC motor dynamic suspension	
	DC-5	2.5	1	7.5	2.5	1	7.5	Starting shunt motor, anti-phase suspension, inching, DC motor dynamic suspension	

Note 1) AC-3 depending on operational load type may be used in temporary inching or anti-phase suspension in case of limit time, number such as operating machines. It is the number which does not exceed five times per minute, which is confined to be less than 10 times in 10 minutes.

Selection and Application

2. Application

2.3 Understanding of Application Categories for AC Circuit Contactor

- Category AC-1** | It is applied to every type of AC load which has a power factor more than 0.95($\cos \phi > 0.95$), there are non-inducing loads, minute inducing loads, and resistance furnace.

 - Application example: heater, incandescent lamp, and general wire distribution

- Category AC-2** | It is applied to driving, plugging, inching of wound-rotor type inducing motor, about 2.5 times of motor rated current is generated as starting current, it can break the starting current at the voltage which is the same as the main power voltage or less when breaking.

- Category AC-3** | It is applied to starting and suspension of squirrel-cage type inducing motor, and plugging and inching are not considered separately from category AC-4. The current when closed circuit is 5~8 times of motor rated current, it is normally used with standard squirrel-cage type motor with 20% of main power during breaking.

 - application example : every standard squirrel-cage type motor (lift, escalator, conveyor belt, bucket elevator, compressor, pump, mixer, air conditioner etc)

- Category AC-4 and AC-2** | It is applied to plugging and inching of squirrel-cage type motors and wound rotor type inducing motors. Contactor is closed with 5~8 times more than rated motor current. And it is operated at the same current with higher, slower speed when breaking. The voltage can be the same as the main voltage.

 - Application example : Printing machine, wire distribution drawing machine, crane and hoist, metal

Test Conditions

AC Category	Normal operation						Occasional operation						
	Making			Breaking			Making			Breaking			
	I	U	cos ϕ	I	U	cos ϕ	I	U	cos ϕ	I	U	cos ϕ	
AC-1	1e	1.05Ue	0.8	1e	1.05Ue	0.8	1.51e	1.05Ue	0.8	1.51e	1.05Ue	0.8	
AC-2	21e	1.05Ue	0.65	21e	1.05Ue	0.65	41e	1.05Ue	0.65	41e	1.05Ue	0.65	
AC-3	le \leq 100A	21e	1.05Ue	0.45	21e	1.05Ue	0.45	101e	1.05Ue	0.45	81e	1.05Ue	0.45
	le $>$ 100A	21e	1.05Ue	0.35	21e	1.05Ue	0.35	101e	1.05Ue	0.35	81e	1.05Ue	0.35
AC-4	le \leq 100A	61e	1.05Ue	0.45	61e	1.05Ue	0.45	121e	1.05Ue	0.35	101e	1.05Ue	0.35
	le $>$ 100A	61e	1.05Ue	0.35	61e	1.05Ue	0.35	121e	1.05Ue	0.35	101e	1.05Ue	0.35

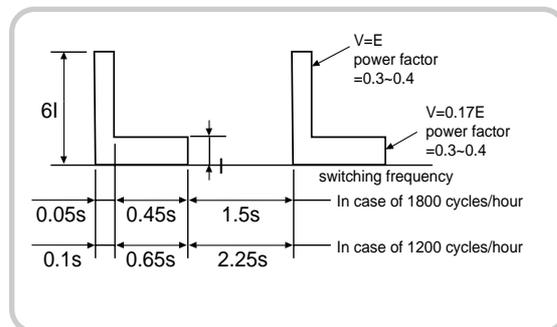

Fig. 32. Category AC3 of electrical switching durability test duty
I : rated operational current E : rated operational Voltage

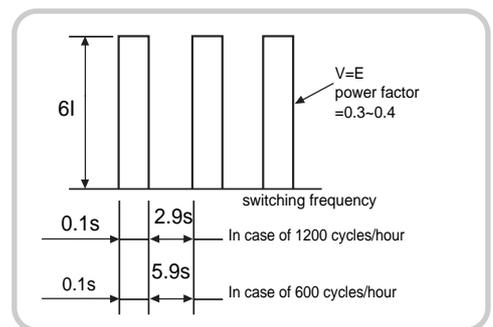

Fig. 33. Category AC4 of electrical switching durability test duty

2.4 Understanding of Application Categories for DC Circuit Contactor (IEC/EN60947-4-1)

- Category DC-1** | Is applied to DC load of every type, when time constant (L/R) is the same as 1ms or less.
- Category DC-3** | Is applied to starting shunt motor, plugging(anti-phase suspension) and inching (time constant $\leq 2\text{ms}$). Contactor has a condition of 2.5 times of motor rated current flowing as starting current when closed circuit, and the circuit is broken with 2.5 times starting current at the voltage is the same or less than the main power voltage when breaking. Counter electromotive force decreases and voltage increases as electrical motor operates slowly, so it is difficult to break.
- Category DC-5** | It is applied to starting, plugging(anti-phase suspension) and inching of series motor(time constant $\leq 7.5\text{ms}$). Contactor has a condition of 2.5 times of motor rated current flowing as starting current when closed circuit, and the circuit current is broken at the higher voltage and lower motor speed. Voltage can be the same as main power voltage.

Test conditions (making and breaking condition)

DC Category	Normal operation						Occasional operation					
	Making			Breaking			Making			Breaking		
	I	U	L/R (ms)	I	U	L/R (ms)	I	U	L/R (ms)	I	U	L/R (ms)
DC-1	1e	1.05Ue	1	1e	1.05Ue	1	1.51e	1.05Ue	1	1.51e	1.05Ue	1
DC-3	2.51e	1.05Ue	2	2.51e	1.05Ue	2	41e	1.05Ue	2.5	41e	1.05Ue	2.5
DC-5	2.51e	1.05Ue	7.5	2.51e	1.05Ue	7.5	41e	1.05Ue	15	41e	1.05Ue	15

2.5 Understanding of Application Categories for Contacts Auxiliary and Control Relays(IEC/EN60947-4-1)

- Category DC-14** | Applied to electromagnetic loads switching by the power when organic electromotive force of breaking electromagnet is less than 72VA, the application range is applied to control coil switching of contactor and relay.
- Category DC-15** | Applied to electromagnetic loads switching by the power when organic electromotive force of electromagnetic breaker is less than 72VA, the application range is applied to control coil switching of contactor and relay.
- Category DC-13** | Applied to electromagnetic load switching ($P \leq 50\text{W}$) like six times of power P that time($T=0.95$) which reaches 95% of normal operation current worn by load. Application range is applied to operation coil switching of magnetic contactor which doesn't have consumption power reducing type resistance.

Test Conditions (Making breaking conditions)

AC Category	Normal operation						Occasional operation					
	Making			Breaking			Making			Breaking		
	I	U	cos ϕ	I	U	cos ϕ	I	U	cos ϕ	I	U	cos ϕ
AC-14	61e	Ue	0.3	1e	Ue	0.3	61e	1.1Ue	0.7	61e	1.1Ue	0.7
AC-15	101e	Ue	0.3	1e	Ue	0.3	101e	1.1Ue	0.3	101e	1.1Ue	0.3
DC-13	1e	Ue	6P ^{Note1)}	1e	Ue	6P ^{Note1)}	1.11e	1.1Ue	6P ^{Note1)}	1e	1.1Ue	6P ^{Note1)}

Note1) The value 6P(W) is based on real axis, $P = 50\text{W}$, in other words it indicates the most magnetic load up to maximum limit of $6P = 300\text{ms} = L/R$. The upper load of this consists of smaller loads in parallel. Therefore 300ms is the maximum limit regardless of rated current value.

Note 2) • U(I) = Applied voltage(current) • U = Voltage recovery • L/R = Test circuit time constant
 • U(I) = Rated operational voltage(current)
 • I = inserted and braking current express symmetric element value such as mean square of DC or AC
 • T = The required time to reach 95% of current for maintaining equilibrium condition.
 Expressed in ms(milliseconds)

Selection and Application

2. Application

2.6 Average Full Load Currents of 3-Phase Squirrel-cage Motors

3 phase 4 pole motors (50/60Hz)

Power		200/ 208V	220V (1)	230V	380V	400V	415V	433/ 440V (1)	460V	500/ 525V (1)	575V	660V	690V	750V	1000V
kW	HP	A	A	A	A	A	A	A	A	A	A	A	A	A	A
0.37	0.5	2	1.8	2	1.03	0.98	-	0.99	1	1	0.8	0.6	-	-	0.4
0.55	0.75	3	2.75	2.8	1.6	1.5	-	1.36	1.4	1.2	1.1	0.9	-	-	0.6
0.75	1	3.8	3.5	3.6	2	1.9	2	1.68	1.8	1.5	1.4	1.1	-	-	0.75
1.1	1.5	5	4.4	5.2	2.6	2.5	2.5	2.37	2.6	2	2.1	1.5	-	-	1
1.5	2	6.8	6.1	6.8	3.5	3.4	3.5	3.06	3.4	2.6	2.7	2	-	-	1.3
2.2	3	9.6	8.7	9.6	5	4.8	5	4.42	4.8	3.8	3.9	2.8	-	-	1.9
3	-	12.6	11.5	-	6.6	6.3	6.5	5.77	-	5	-	3.8	3.5	-	2.5
-	5	-	-	15.2	-	-	-	-	7.6	-	6.1	-	-	-	3
4	-	16.2	14.5	-	8.5	8.1	8.4	7.9	-	6.5	-	4.9	4.9	-	3.3
5.5	7.5	22	20	22	11.5	11	11	10.4	11	9	9	6.6	6.7	-	4.5
7.5	10	28.8	27	28	15.5	14.8	14	13.7	14	12	11	6.9	9	-	6
9	-	36	32	-	18.5	18.1	17	16.9	-	13.9	-	10.6	10.5	-	7
11	15	42	39	42	22	21	21	20.1	21	18.4	17	14	12.1	11	9
15	20	57	52	54	30	28.5	28	26.5	27	23	22	17.3	16.5	15	12
18.5	25	70	64	68	37	35	35	32.8	34	28.5	27	21.9	20.2	18.5	14.5
22	30	84	75	80	44	42	40	39	40	33	32	25.4	24.2	22	17
30	40	114	103	104	60	57	55	51.5	52	45	41	54.6	33	30	23
37	50	138	126	130	72	69	66	64	65	55	52	42	40	36	28
45	60	162	150	154	85	81	80	76	77	65	62	49	46.8	42	33
55	75	200	182	192	105	100	100	90	96	80	77	61	58	52	40
75	100	270	240	248	138	131	135	125	124	105	99	82	75.7	69	53
90	125	330	295	312	170	162	165	146	156	129	125	98	94	85	65
110	150	400	356	360	205	195	200	178	180	156	144	118	113	103	78
132	-	480	425	-	245	233	240	215	-	187	-	140	135	123	90
-	200	520	472	480	273	222	260	236	240	207	192	152	-	136	100
160	-	560	520	-	300	285	280	256	-	220	-	170	165	150	115
-	250	-	-	600	-	-	-	-	300	-	240	200	-	-	138
200	-	680	626	-	370	352	340	321	-	281	-	215	203	185	150
220	300	770	700	720	408	388	385	353	360	310	288	235	224	204	160
250	350	850	800	840	460	437	425	401	420	360	336	274	253	230	200
280	-	-	-	-	528	-	-	-	-	-	-	-	-	-	220
315	-	1070	990	-	584	555	535	505	-	445	-	337	321	292	239
-	450	-	-	1080	-	-	-	-	540	-	432	-	-	-	250
355	-	-	1150	-	635	605	580	549	-	500	-	370	350	318	262
-	500	-	-	1200	-	-	-	-	600	-	480	-	-	-	273
400	-	-	1250	-	710	675	650	611	-	540	-	410	390	356	288
450	600	-	-	1440	-	-	-	-	720	-	576	-	-	-	320
500	-	-	1570	-	900	855	820	780	-	680	-	515	494	450	350
560	-	-	1760	-	1000	950	920	870	-	760	-	575	549	500	380
630	-	-	1980	-	1100	1045	1020	965	-	850	-	645	605	550	425
710	-	-	-	-	1260	1200	1140	1075	-	960	-	725	694	630	480

(1) The values adhere to NEC(National Electrical Code). These values are given as one direction. They can vary depending on motor and manufacturer.

2.7 Making and Breaking Conditions

- D.C. power circuit switching**

Arc restraint is more difficult in DC than AC. Moreover, it is more difficult as circuit time constant is higher. This is the reason that many poles should be connected in series to increase breaking condition.

- A.C. current circuit switching**

Possibility of increasing performance by connected poles in parallel

- Effect of terminal length**

According to operation voltage, coil consumption and control lay-out, the problem by railway resistance and capacitance can happen during magnetic contactor insertion and breaking order.

Making and breaking condition according to application categories

category	Durability conditions						Occasional operation					
	Making			Breaking			Making			Breaking		
	I/I	U/U	cos ϕ or L/R(ms)	I/I	U/U	cos ϕ or L/R(ms)	I/I	U/U	cos ϕ or L/R(ms)	I/I	U/U	cos ϕ or L/R(ms)

Magnetic contactors for A.C. circuit switching

AC-1	1	1	0.95	1	1	0.95	1.5	1.05	0.8	1.5	1.05	0.8	
AC-2	2.5	1	0.65	2.5	1	0.65	4	1.05	0.65	4	1.05	0.65	
AC-3	$I \leq 17A$	6	1	0.65	1	0.17	0.65	10	1.05	0.45	8	1.05	0.45
	$17 < I \leq 100A$	6	1	0.35	1	0.17	0.35	10	1.05	0.45	8	1.05	0.45
	$I > 100A$	6	1	0.35	1	0.17	0.35	10	1.05	0.35	8	1.05	0.35
AC-4	$I \leq 17A$	6	1	0.65	6	1	0.65	12	1.05	0.45	10	1.05	0.45
	$17 < I \leq 100A$	6	1	0.35	6	1	0.35	12	1.05	0.45	10	1.05	0.45
	$I > 100A$	6	1	0.35	6	1	0.35	12	1.05	0.35	10	1.05	0.35

Magnetic contactors for D.C. circuit switching

DC-1	1	1	1	1	1	1	1.5	1.05	1	1.5	1.05	1
DC-3	2.5	1	2	2.5	1	2	4	1.05	2.5	4	1.05	2.5
DC-5	2.5	1	7.5	2.5	1	7.5	4	1.05	15	4	1.05	15

Comtactor relays for A.C. circuit switching

AC-14 ($\leq 72VA$)	-	-	-	-	-	-	9	1.1	0.7	6	1.1	0.7
AC-15 ($> 72VA$)	10	1	0.7	1	1	0.4	10	1.1	0.3	10	1.1	0.3

Selection and Application

2. Application

2.7 Making and Breaking Conditions

Contactor relays for D.C. circuit switching for application Categories

Category	Standard operation						Occasional operation					
	Making			Breaking			Making			Breaking		
	I/I	U/U	T	I/I	U/U	T	I/I	U/U	T	I/I	U/U	T
DC-13	1	1	6P ^{Note 1)}	1	1	6P ^{Note 1)}	1.1	1.1	6P ^{Note 1)}	1.1	1.1	6P ^{Note 1)}
DC-14	-	-	-	-	-	-	10	1.1	15ms	10	1.1	15ms

Note 1) "6 x P" is the expected test result for expressing the most DC magnetic load upto the maximum limit of P = 50 W(6 x P = 300ms). It is allowed that load which has more than 50W combination energy is composed with the less load of parallel. As a result, 300ms value conforms the maximum limit regardless of combination power value.

Note 2) U(I): application voltage(current)

Ur: reset voltage

L/R: test circuit time constant

Uo(Io): rated operation voltage(current)

Ic: insertion and breaking current expressed DC and AC such as r.m.s value of symmetric part.

T0.95: required time for reaching 95% of current with certain stopping condition. It is expressed with limit seconds.

2.8 Application Data for Category AC-1

Maximum operational current and power(open-mounted device)

Operational current and power		Type	18AF				22AF				40AF		65AF	
			6a	9a	12a	18a	9b	12b	18b	22b	32a	40a	50a	65a
Maximum operating rate in operating cycles / hour			600											
Cable	mm ²		4	4	10	4	10			10	16	25	35	
maximum operational current Ie ≤40°C	A		25	25	25	32	25	25	32	40	50	60	70	100
maximum operational power ≤55°C	220/240V		10	10	10	13	10	10	13	17	21	25	29	42
	380/440V		19	19	19	24	19	19	24	30	38	46	53	76
	500/550V		24	24	24	30	24	24	30	38	48	57	67	95
	690V		30	30	48	48	30	48	48	60	72	84	90	120

Operational current and power		Type	100AF			150AF		225AF		400AF			800AF		
			75a	85a	100a	130a	150a	185a	225a	265a	330a	400a	500a	630a	800a
Maximum operating rate in operating cycles / hour			600					-							
Cable	mm ²		35	50		70	95		150	240		370	480	-	-
maximum operational current Ie ≤40°C	A		110	135	140	160	210	230	275	300	350	450	580	660	900
maximum operational power ≤55°C	220/240V		46	56	58	61	80	88	105	114	133	171	221	251	343
	380/440V		84	103	107	105	138	151	181	197	230	296	382	434	592
	500/550V		105	129	133	139	182	199	238	260	303	390	502	572	779
	690V		131	161	167	191	251	275	329	359	418	538	693	789	1076

■ **Operational current when connected in parallel**

It can be applied with multiplying the values from the upper table and K value, when using contactor with more than 2 pole connection in parallel.

- 2pole in parallel K = 1.6
- 3pole in parallel K = 2.25
- 4pole in parallel K = 2.8

■ **Selection guide for electrical durability**

- Operational voltage : less than AC 440V
- Power factor : more than 0.95
- It follows when it is applied to resistance load such as heating resistance.

Category	Making and breaking capacity		Electric switching durability	
	Making	Breaking	Making	Breaking
AC-1	1.5Ie, 1.1Ee Cos Ø 0.95	1.5Ie, 1.1Ee Cos Ø 0.95	Ie, Ee Cos Ø 0.95	Ie, Ee Cos Ø 0.95

Note) Ie: rated operational current, Ee: rated voltage, CosØ: Power factor

The entire load current of motor is applied at the horizontal axis, because current value(Ic) of horizontal axis is same as rated current value(Ie) of load in AC1 load.

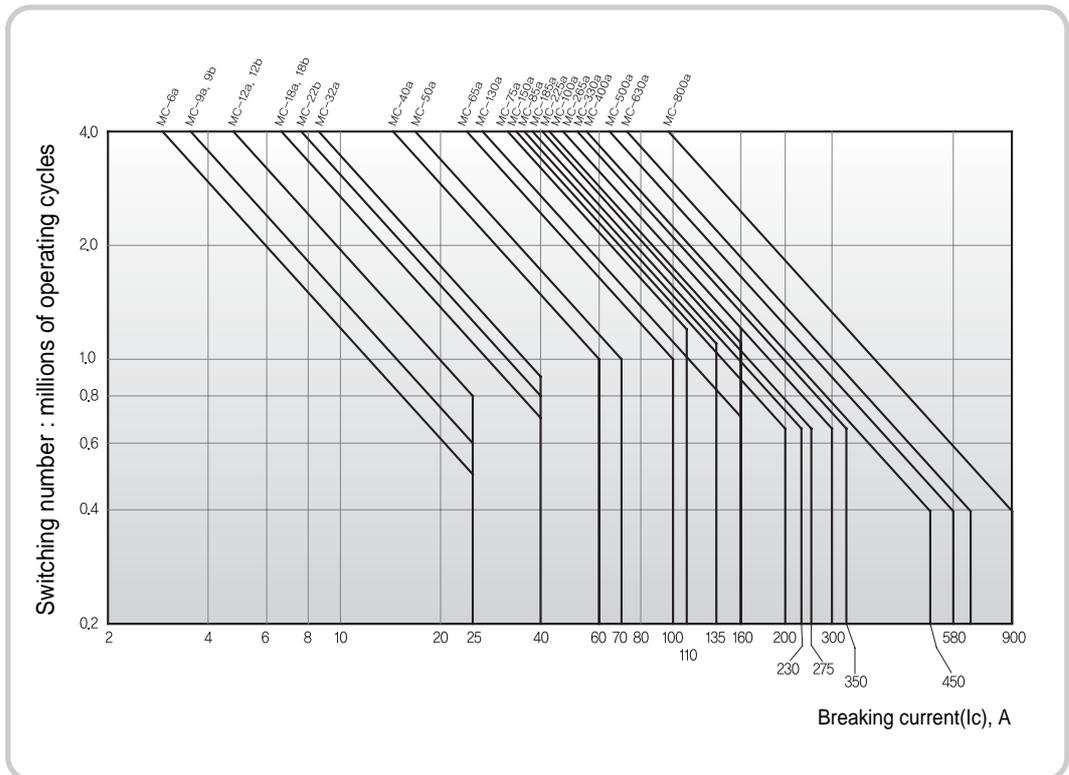

Selected example) MC-65a should be selected when Ue=220V, Ie 50A and operational surrounding temperature is less than 40°C, required life span is 2 million times.

Selection and Application

2. Application

2.9 Application Data for Categories AC-3

1. Maximum operational current and power (IEC, $\theta \leq 55^\circ \text{C}$)

Operational current and power		Type		18AF				22AF				40AF		65AF	
				6a	9a	12a	18a	9b	12b	18b	22b	32a	40a	50a	65a
Max operational current	$\leq 440\text{V}$	A	7	9	12	18	9	12	18	22	32	40	50	65	
Rated operational power (standard motor power rated)	220/240V	kW	2.2	2.5	3.5	4.5	2.5	3.5	4.5	5.5	7.5	11	15	18.5	
	380/440V	kW	3	4	5.5	7.5	4	5.5	7.5	11	15	18.5	22	30	
	500/550V	kW	3	4	7.5	7.5	4	7.5	7.5	15	18.5	22	30	33	
	690V	kW	3	4	7.5	7.5	4	7.5	7.5	15	18.5	22	30	33	

Operational current and power		Type		100AF			150AF		225AF		400AF			800AF		
				75a	85a	100a	130a	150a	185a	225a	265a	330a	400a	500a	630a	800a
Max operational current	$\leq 440\text{V}$	A	75	85	95	120	150	185	225	265	330	400	500	630	800	
Rated operational power (standard motor power rated)	220/240V	kW	22	25	30	37	45	55	75	80	90	125	147	190	220	
	380/440V	kW	37	45	55	60	75	90	132	147	160	200	265	330	400	
	500/550V	kW	37	45	55	60	75	110	132	147	160	225	265	330	400	
	690V	kW	37	45	55	55	75	110	140	160	200	250	300	400	500	

2. Maximum operational current and power (UL, CSA, $\theta \leq 55^\circ \text{C}$)

Operational current and power		Type		18AF				22AF				40AF		65AF		100AF		
				6a	9a	12a	18a	9b	12b	18b	22b	32a	40a	50a	65a	75a	85a	100a
Continuous Current (A)			25	25	25	32	25	25	32	40	50	60	70	100	110	135	160	
Rated operational power (standard motor power rated) 50/60Hz	1HP	100~120V	0.5	0.5	0.75	1	0.5	0.75	1	2	2	3	3	5	5	7.5	10	
		220~240V	1.5	1.5	2	3	1.5	2	3	3	5	7.5	10	15	15	15	20	
	3HP	200~208V	2	2	3	5	2	3	5	7.5	7.5	15	20	25	25	30	30	
		220~240V	3	3	5	7.5	3	5	7.5	10	10	20	25	30	30	40	40	
		440~480V	5	5	7.5	10	5	7.5	10	15	20	30	40	50	50	60	75	
		550~600V	7.5	7.5	10	15	7.5	10	15	20	25	30	50	60	60	75	75	

Operational current and power		Type		150AF		225AF		400AF			800AF		
				130a	150a	185a	225a	265a	330a	400a	500a	630a	800a
Continuous Current (A)			160	210	230	275	300	350	450	580	660	900	
Rated operational power (standard motor power rated) 50/60Hz	1HP	100~120V	10	15	15	15	-	-	-	-	-	-	
		220~240V	20	25	30	40	-	-	-	-	-	-	
	3HP	200~208V	40	40	60	60	75	100	125	150	200	200	
		220~240V	40	50	60	75	100	125	150	200	250	300	
		440~480V	75	100	125	150	200	250	300	400	500	600	
		550~600V	75	75	125	150	200	250	300	400	500	600	

3. Max. operating rate in operating cycles / hour

Type name		18AF				22AF				40AF		65AF	
		6a	9a	12a	18a	9b	12b	18b	22b	32a	40a	50a	65a
Operating cycles		1800	1800	1800	1800	1800	1800	1800	1800	1800	1800	1200	1200
1/h		1800	1800	1800	1800	1800	1800	1800	1800	1800	1800	1200	1200

Type name		100AF			150AF		225AF		400AF			800AF		
		75a	85a	100a	130a	150a	185a	225a	265a	330a	400a	500a	630a	800a
Operating cycles		1200	1200	1200	1200	1200	1200	1200	1200	1200	1200	1200	1200	1200
1/h		1200	1200	1200	1200	1200	1200	1200	1200	1200	1200	1200	1200	1200

■ Selection guide for electrical durability (category AC-3)

Operational voltage : less than 440V

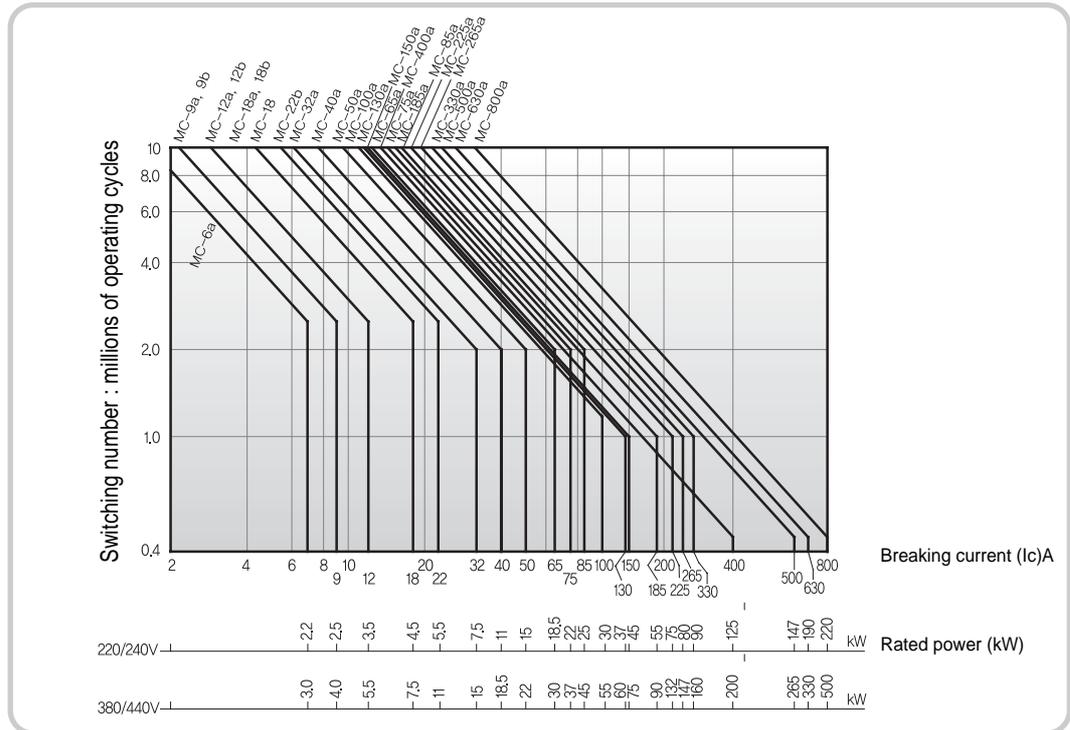

Selection example) When motor capacity P=5.5kW, Ue=400V, Ie=11A, Ic is equal to Ie. so when required life span of 11A is 3 million times, MC-12a should be selected.

Operational voltage : less than AC660/690V

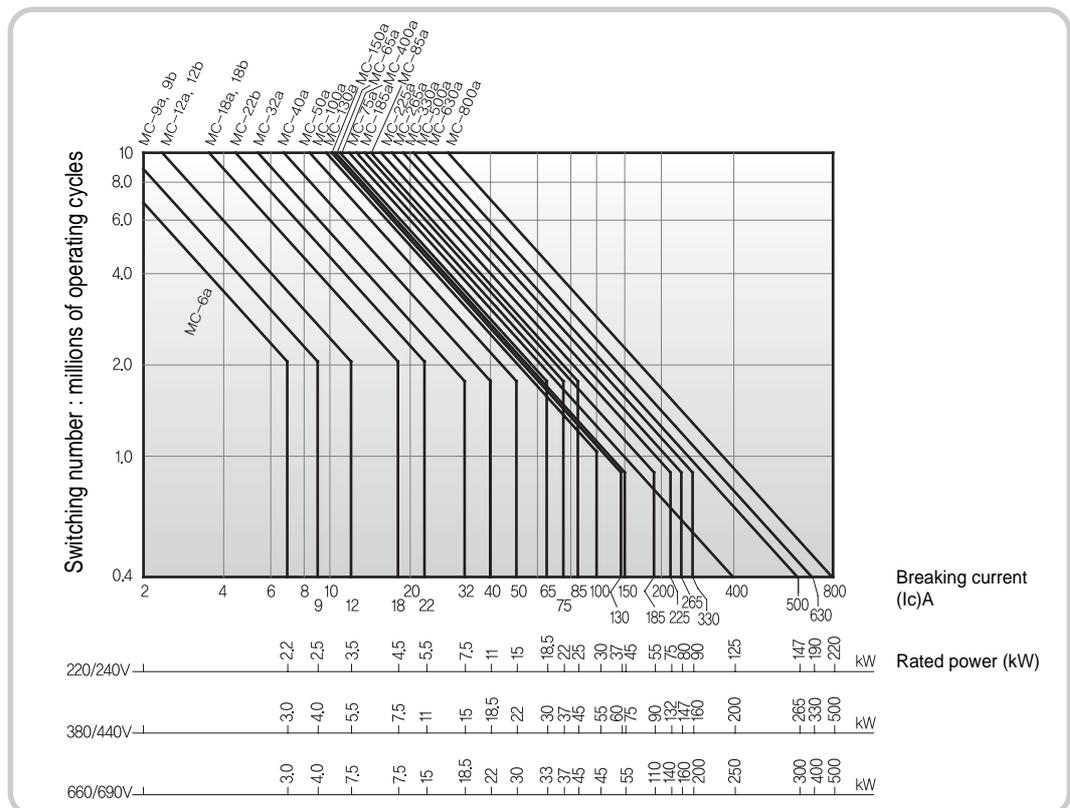

Selection and Application

2. Application

2.10 Application Data for Categories AC-2 or AC-4

1. Maximum breaking current

- AC-2 : Wound-rotor type(slipping) motor- starting breaking current
- AC-4 : Squirrel-cage motor- starting breaking current

AC-4 maximum breaking current	Type name	18AF				22AF				40AF		65AF	
		6a	9a	12a	18a	9b	12b	18b	22b	32a	40a	50a	65a
	Ue ≤ 440V	36	54	72	108	54	72	108	132	192	240	300	390
	440V < Ue ≤ 690V	26	40	50	70	40	50	70	80	105	150	170	210

AC-4 maximum breaking current	Type name	100AF			150AF		225AF		400AF			800AF		
		75a	85a	100a	130a	150a	185a	225a	265a	330a	400a	500a	630a	800a
	Ue ≤ 440V	450	510	570	780	900	1110	1350	1590	1980	2400	3000	3600	4800
	440V < Ue ≤ 690V	210	250	250	540	640	708	810	1020	1410	1830	2130	2760	2910

Note) Ie maximum breaking current= 6 X I motor(A)

2. Maximum operational current according to operation cycle and load factor operational current^{Note1)} $\theta \leq 55^\circ\text{C}$ ^{Note2)}

Operating cycle and load factor	Maximum operational current	18AF				22AF				40AF		65AF	
		6a	9a	12a	18a	9b	12b	18b	22b	32a	40a	50a	65a
150 & 15% ~ 300 & 10%	A	20	30	40	45	30	40	45	50	80	110	140	150
150 & 20% ~ 600 & 10%	A	18	27	36	40	27	36	40	45	70	96	120	135
150 & 30% ~ 1200 & 10%	A	16	24	30	35	24	30	35	40	60	80	100	120
150 & 55% ~ 2400 & 10%	A	13	19	24	30	19	24	30	35	50	62	80	100
150 & 85% ~ 3600 & 10%	A	10	16	21	25	16	21	25	30	45	53	70	75

Operating cycle and load factor	Maximum operational current	100AF			150AF		225AF		400AF			800AF		
		75a	85a	100a	130a	150a	185a	225a	265a	330a	400a	500a	630a	800a
150 & 15% ~ 300 & 10%	A	180	200	200	300	310	380	420	560	670	780	1100	1300	1600
150 & 20% ~ 600 & 10%	A	165	170	170	260	280	350	400	500	600	700	950	1190	1400
150 & 30% ~ 1200 & 10%	A	145	145	145	230	240	300	330	400	500	600	750	900	1100
150 & 55% ~ 2400 & 10%	A	130	120	120	140	150	240	270	320	390	450	600	680	820
150 & 85% ~ 3600 & 10%	A	110	100	100	130	145	170	190	230	290	350	500	630	710

Note 1) DC doesn't exceed maximum value of machine operation cycle.

Note 2) Operation rated value such as 80% of the real value is selected in cases where temperature is higher than 55°C.

3. Plugging

There are various current type from maximum plugging breaking current to rated motor current. The input current is suitable for rated input/ breaking capacity of magnetic contactor. Magnetic contactor can be restrained when breaking happens normally at locked rotor current or near it.

4. AC-4 power rated capacity

Operational voltage	Rated capacity	18AF				22AF				40AF		65AF	
		6a	9a	12a	18a	9b	12b	18b	22b	32a	40a	50a	65a
200/240V	kW	1.5	1.5	2.2	3.7	1.5	2.2	3.7	3.7	4.5	5	5.5	7.5
380/400V	kW	2.2	2.2	4	4	2.2	4	4	5.5	7.5	9	11	11
415V	kW	2.2	2.2	4	4	2.2	4	4	5.5	7.5	9	11	11
440V	kW	2.2	2.2	4	4	2.2	4	4	5.5	7.5	9	11	15

Operational voltage	Rated capacity	100AF			150AF		225AF		400AF			800AF		
		75a	85a	100a	130a	150a	185a	225a	265a	330a	400a	500a	630a	800a
200/240V	kW	7.5	7.5	9	22	30	37	45	50	55	75	90	110	160
380/400V	kW	11	15	15	45	55	75	90	102	110	150	176	200	300
415V	kW	11	15	15	45	55	75	90	102	110	150	176	200	300
440V	kW	15	15	15	45	55	75	90	102	110	150	176	200	300

Selection and Application

2. Application

2.10 Application Data for Categories AC-2 or AC-4

Selection guide for electrical durability

Driving 3 phase squirrel-cage type motor(AC4) or Wound-rotor type motor(AC2) (Including breaking with restrained motor condition)
 Breaking current in category AC4, I_c is 6 times of motor rated current, i.e. $I_c=6 \times I_e$

Operational voltage : less than 440V (category AC-4)

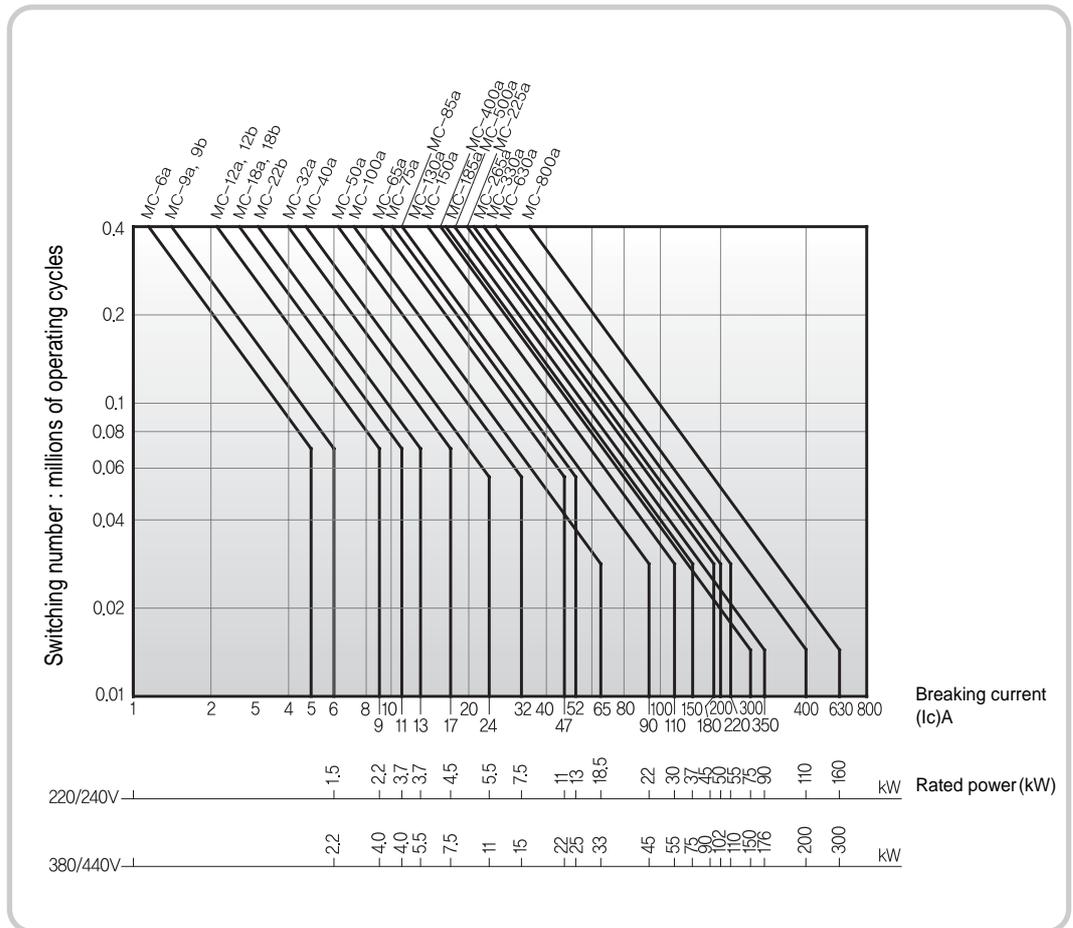

<Example> $I_c=6 \times I_e=66A$, when Motor capacity $P=5.5Kw$, $U_e=400V$, $I_e=11A$.
 MC-22a should be selected when required life span is 200,000 times.

2.11 Application Data for Categories DC-1 or DC-5

Magnetic contactor can be applied to higher current level compared to motor load, because inrush current is small, power factor is large in case of resistance load switching of electric furnace heater, heater. Metasol series magnetic contactor is manufactured according to the standard [KS C IEC 60947-4-1], and it has the performance as following table.

There is an enough margin in closed circuit and breaking capacity, but there is a limit in temperature increase, when magnetic contactor is applied to resistance load, therefore, the rated value is upto rated flow current. Flow current can be increased by using parallel connection of contact in single phase circuit. In this case, rated flow current I can be theoretically calculated by following equation. User should evaluate on their own, when real operational condition is different from the following condition.

$$I = 2 \sqrt{N - 1 \times I_o} \quad I_o: 1 \text{ pole's rated current } N: \text{Number of poles in parallel}$$

1. Resistance loads(category DC-1) : time constant L/R= 1ms

Rated operational voltage Ue	Number of poles connected in series	Rated operational current (A)											
		18AF				22AF				40AF		65AF	
		6a	9a	12a	18a	9b	12b	18b	22b	32a	40a	50a	65a
24V	1	15	15	15	30	15	15	30	30	30	40	50	50
	2	18	18	18	32	18	18	32	32	32	55	70	70
	3	20	20	20	32	20	20	32	32	32	55	70	70
48 / 75V	1	12	12	12	25	12	12	25	25	25	25	25	25
	2	17	17	17	30	17	17	30	30	30	55	70	70
	3	20	20	20	32	20	20	32	32	32	55	70	70
110V	1	6	6	8	8	6	8	8	8	8	8	8	8
	2	12	12	12	25	12	12	25	25	25	40	50	60
	3	15	15	15	27	15	15	27	27	27	45	60	65
220V	1	4	4	5	5	4	5	5	5	5	5	5	5
	2	8	8	8	15	8	8	15	15	15	35	40	40
	3	10	10	10	22	10	10	22	22	22	40	50	50

Rated operational voltage Ue	Number of poles connected in series	Rated operational current (A)												
		100AF			150AF		225AF		400AF			800AF		
		75a	85a	100a	130a	150a	185a	225a	265a	330a	400a	500a	630a	800a
24V	1	70	70	70	200	200	240	260	300	360	430	580	850	1300
	2	100	100	100	200	200	240	260	300	360	430	580	850	1300
	3	100	100	100	200	200	240	260	300	360	430	580	850	1300
48 / 75V	1	25	25	25	200	200	240	260	300	360	430	580	850	1300
	2	100	100	100	200	200	240	260	300	360	430	580	850	1300
	3	100	100	100	200	200	240	260	300	360	430	580	850	1300
110V	1	8	8	8	180	180	210	230	270	320	380	520	760	1180
	2	80	80	80	180	180	210	230	270	320	380	520	760	1180
	3	85	85	85	200	200	210	230	300	360	430	580	850	1300
220V	1	5	5	5	160	160	-	-	-	-	-	-	-	-
	2	45	45	45	160	160	190	200	250	260	350	450	700	1000
	3	55	55	55	200	200	240	200	300	360	430	580	850	1300

Selection and Application

2. Application

2.11 Application Data for Categories DC-1 or DC-5

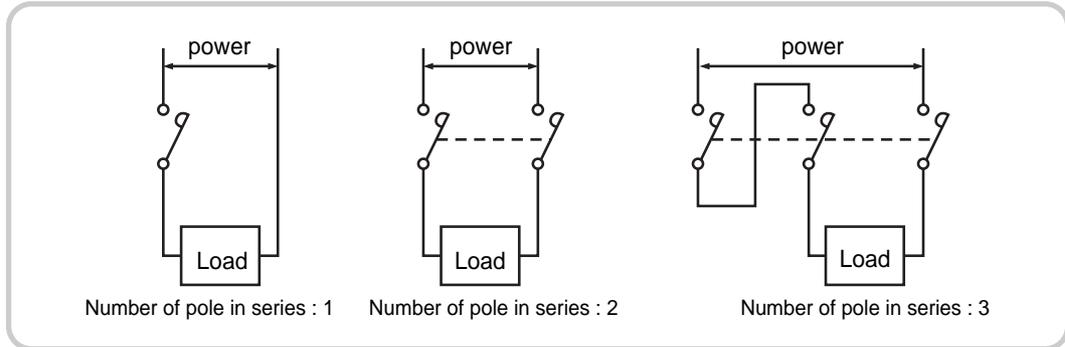

Fig. 34. Type of series connection pole

2. DC electric motor loads(category DC-2~DC-5) : time constant L/R= 15ms

Rated operational voltage Ue	Number of poles connected in series	Rated operational current (A)											
		18AF				22AF				40AF		65AF	
		6a	9a	12a	18a	9b	12b	18b	22b	32a	40a	50a	65a
24V	1	12	12	12	12	12	12	12	12	20	20	35	35
	2	15	15	15	15	15	15	15	15	25	25	45	45
	3	18	18	18	18	18	18	18	18	30	30	55	55
48 / 75V	1	10	10	10	10	10	10	10	10	15	15	15	15
	2	12	12	12	12	12	12	12	12	20	20	40	40
	3	15	15	15	15	15	15	15	15	30	30	50	50
110V	1	2	2	2	2.0	2	2	2.0	2.0	2.5	2.5	2.5	2.5
	2	8	8	8	8	8	8	8	8	15	15	25	25
	3	12	12	12	12	12	12	12	12	20	20	35	35
220V	1	0.75	0.75	0.75	1	0.75	0.75	1	1	1	1	1	1
	2	1.5	1.5	1.5	2	1.5	1.5	2	2	3	3	5	5
	3	6	6	6	6	6	6	6	6	10	10	25	25

Rated operational voltage Ue	Number of poles connected in series	Rated operational current (A)													
		100AF			150AF		225AF		400AF			800AF			
		75a	85a	100a	130a	150a	185a	225a	265a	330a	400a	500a	630a	800a	
24V	1	40	40	40	200	200	240	260	300	360	430	580	850	1300	
	2	60	60	60	200	200	240	260	300	360	430	580	850	1300	
	3	80	80	80	200	200	240	260	300	360	430	580	850	1300	
48 / 75V	1	15	15	15	200	200	240	260	300	360	430	580	850	1300	
	2	50	50	50	200	200	240	260	300	360	430	580	850	1300	
	3	70	70	70	200	200	240	260	300	360	430	580	850	1300	
110V	1	2.5	2.5	2.5	100.0	100.0	-	-	-	-	-	-	-	-	
	2	40	40	40	140	140	160	180	250	300	350	500	700	1000	
	3	60	60	60	200	200	240	240	250	310	350	550	850	1000	
220V	1	1	1	1	100	100	-	-	-	-	-	-	-	-	
	2	7	7	7	120	120	140	160	220	280	310	480	680	900	
	3	35	35	35	140	140	160	160	250	300	350	500	700	1000	

2.12 Circuit of Slip-ring Motors

A magnetic contactor used for short-circuiting rotor resistors can be used with their normal operation voltage. Condition of rotor magnetic contactor is different depending on connection mode of main pole. Current value with circuit input, current and voltage value with breaking circuit (generally besides low load factor) flow easily to the magnetic contactor.

■ Rotor connection

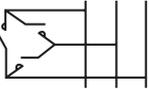
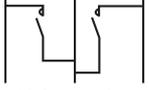
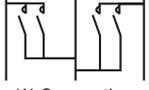
Type of connection Connection circuit	Connection method	Multiple factor	Maximum 3 phase rotor voltage Ue	3 phase rotor voltage with counter - current breaking
 Delta Connection	Delta	1.4	1250V	625V
 V Connection	In V	1	1250V	625V
 W Connection	In W	1.6	1250V	750V

Type Operation time Connection	Operational current (A)															
	18AF			22AF			40AF		65AF		100AF					
	6a	9a	12a	18a	9b	12b	18b	22b	32a	40a	50a	65a	75a	85a	100a	
Intermediate contactor (operating cycles ≤30/h)	6s	36	60	60	90	60	60	90	90	130	210	250	300	330	360	380
	12s	30	50	50	60	50	50	60	60	125	160	200	250	275	300	320
	20s	21	35	35	45	35	35	45	45	90	100	110	120	135	150	170
Rotor short-circuiting contactor and intermediate contactor (operating cycles >30/h)		15	25	25	32	25	25	32	32	50	60	80	80	100	125	140

Type Operation time Connection	Operational current (A)										
	150AF		225AF		400AF			800AF			
	130a	150a	185b	225b	265b	330a	400a	500a	630a	800a	
Intermediate contactor (operating cycles ≤30/h)	6s	390	450	550	670	800	900	1100	1500	2000	2500
	12s	250	280	400	480	550	600	730	1000	1500	2000
	20s	190	220	300	360	400	450	550	750	1200	1500
Rotor short-circuiting contactor and intermediate contactor (operating cycles >30/h)		170	200	270	330	350	420	500	700	1000	1600

Selection and Application

2. Application

2.13 Capacitor Load Application

High peak should be considered when harmonic wave current is generated during continuous duty. For this application, IEC publication 947-4-1 regulates the application category AC-6b. Allowed operation current or power about magnetic contactor is determined by our electrical test. IEC publication 947-4-1 provides calculation formula with determining operation current (Table VII b). Applying magnetic contactor to condenser load is mainly for condenser switching of phase advance. Using phase advancing condenser generates damages to voltage, current wave, noise increase of motor, transformer is caused by this damage, therefore, voltage and current damages by the 5th harmonic wave are restrained with generally inserting 6% series reactor of condenser reactance. This reactor has an effect of not only improving wave form, but restraining rush current when input, therefore it is recommended to use with every condenser circuit. It is necessary to check the phenomena in case of condenser switching by magnetic contactor. Condenser capacity required to improve load power factor from $\cos \theta_1$ to $\cos \theta_2$ is calculated as following.

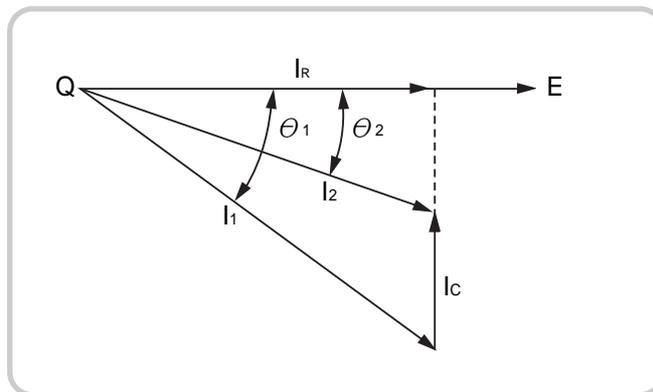

- E: Voltage
- I₁: Current before phase advance
- I₂: Current after phase advance
- I_c: Current for phase advance
- I_R: Effective load current
- $\cos \theta_1$: Power factor before phase advance
- $\cos \theta_2$: Power factor after phase advance
- Q: Required capacitor power

Fig. 35. Capacitor capacity and variation chart of power factor

$$Q = EI_c = EI_R (\tan \theta_1 - \tan \theta_2) = EI_R \left(\sqrt{\frac{1}{\cos^2 \theta_1} - 1} - \sqrt{\frac{1}{\cos^2 \theta_2} - 1} \right)$$

Application example) Required capacitor power Q(kvar) to improve load factor $\cos \theta_1 = 0.7$, capacity $EI_R = 100\text{Kw}$ to $\cos \theta_2 = 0.95$, is as follows.

$$Q = 100 \left(\sqrt{\frac{1}{0.7^2} - 1} - \sqrt{\frac{1}{0.95^2} - 1} \right) = 100 \times 0.69 = 69 \text{ (kvar)}$$

The following table shows the calculated equation of required capacitor capacity (168P).

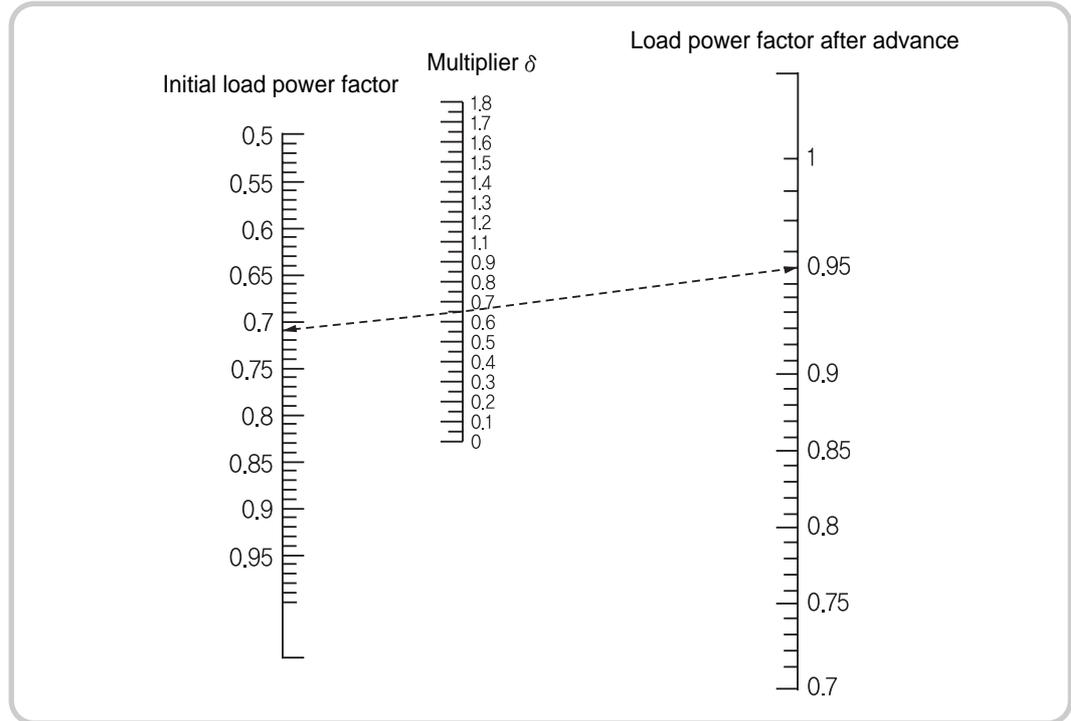

Fig. 36. Capacitor power calculating power

Application example) To advance load power factor from 0.7, power 100kW to power factor 0.95, then setting solution multiplier $\delta=0.69$ is required as following figure, Required capacitor capacity

$$Q = 100 \times 0.69 = 69\text{kvar}$$

■ Input of capacitor

Rush current is determined by circuit impedance when there is no series reactor in the capacitor, generally with a few times to tens of times of original rush current, it becomes extreme to the magnetic contactor.

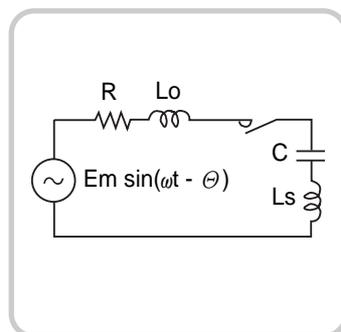

Fig. 37. Capacitor closing equivalent

$$I_{max} = \left(\frac{I}{\omega \sqrt{L_o + L_s}} + 1 \right) I_m$$

$$I_m = \frac{E_m}{\sqrt{R^2 + \omega^2 (L_o + L_s)^2 + \frac{I}{\omega^2 C}}} \doteq \frac{E_m}{\sqrt{\omega^2 L_s^2 + \frac{I}{\omega^2 C^2}}}$$

I_{max} : Rush current R : Circuit resistance L_s : series reactor
 I_m : Normal current L_o : Circuit impedance C : Condenser

Maximum value of rush current becomes 5 times of normal current, when $L_o < L_s$, $\omega^2 L_s C = 0.06$ with series reactor.

Selection and Application

2. Application

2.13 Capacitor Load Application

Capacitor breaking

Voltage between contacts of magnetic contactor is low, so it becomes extinct easily, because of residual electric charge of condenser when breaking. Re-striking is generated in case that insulation recovery isn't connected between contacts from abruptly emerging recovery voltage. According to figure 38, electric charge remains with wave height value of voltage at condenser terminal during breaking, recovery voltage which happens between contacts is given with difference of condenser residual voltage and power voltage, voltage between contacts of breaking moment is small, it passes through 0.5 cycle and indicates approximately 2 times of power voltage right after breaking. Re-striking will occur, if the insulation recovery characteristic between contacts is lower than this.

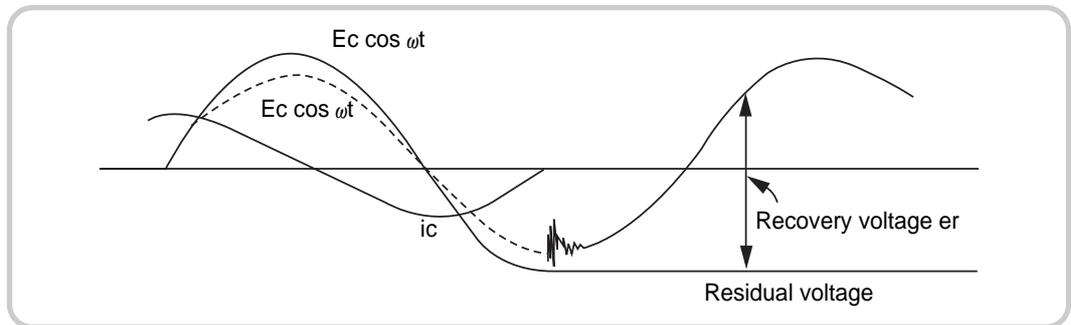

Fig. 38. Recovery voltage wave form between poles of switch

In case of re-striking, the over-voltage of the condenser increases up to approximately three times that of normal voltage, and the re-striking current reaches more than several ten times that of the normal current. It then has a bad influence on the system. If there is a series reactor (6%) and re-striking maximum current is restrained, it becomes less than 9 times of normal current. With application for phase advance condenser because of this, it's necessary to make sure that maximum value of rush current is less than the AC3 class closed circuiting current capacity of magnetic contactor by inserting series reactor. Rush current increases when inserted series reactor is reduced, therefore it's necessary to apply the magnetic contactor with a large rated current. The magnetic contactor is applied, when series reactor is small with the standard of 6% series reactor. Fig. 38 shows relation of magnetic rated current increase rate.

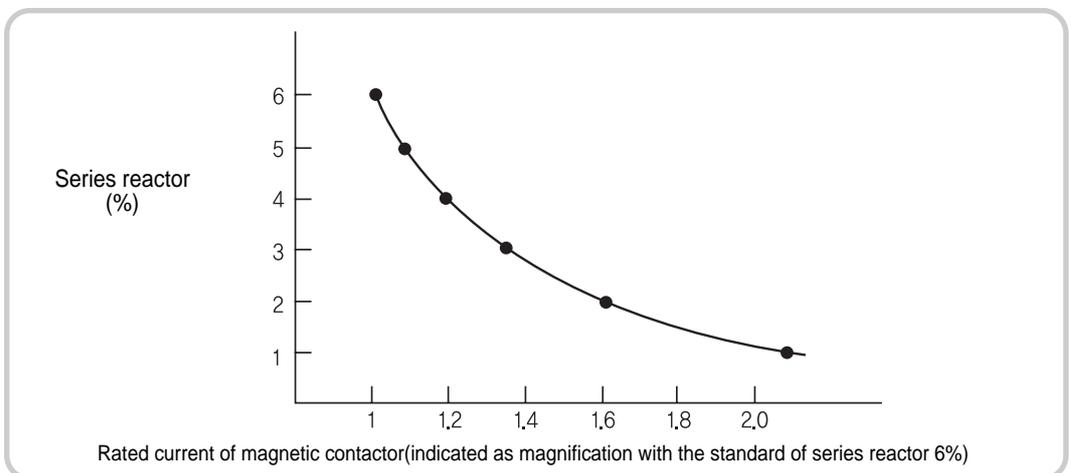

Fig. 39. Characteristic curve of series reactor and contactor rated current

Application example : Category AC3 rated current 100A frame is selected, when series reactor 6%, and 125A frame is selected upper frame of $100 \times 1.2 = 120A$, when series reactor is reduced 4%.

■ **Switching capacitor banks switching**

The following things should be considered, when using a magnetic contactor with a switching condenser to improve the power factor.

- 1) Enduring inrush current determines impedance of circuit during circuit closing.
- 2) Rated flow current is more than 1.3 x 1.1 times condenser' s rated current (according to KSC4801 low voltage phase advance condenser)
- 3) No re-striking, exploding when breaking

■ **Selection**

When Metasol type magnetic contactor is applied to condenser load, operational capacity table of magnetic contactor is as following. It is necessary to carefully select the gauge of wire, because the wire won' t be able to be connected to contactor' s terminal if its too large.

■ **Maximum operational power of contactors**

Maximum operating rate : 120 operating cycles / hour
 Electrical durability : 100,000 operating cycles
 Use with connecting damping resistor when required.

Operational power, 50/60Hz						Maximum peak current (A)	contactor size
0 ≤ 40° C			0 ≤ 55° C ^{Note)}				
220V 240V Kvar	400V 440V Kvar	600V 690V Kvar	220V 240V Kvar	400V 440V Kvar	600V 690V Kvar		
2.2	3	3	2.2	3	3	300	MC-6a
2.5	4	4	2.5	4	4	500	MC-9a(b)
3.5	5.5	7.5	3.5	5.5	7.5	560	MC-12a(b)
4.5	7.5	7.5	4.5	7.5	7.5	850	MC-18a(b)
5.5	11	15	5.5	11	15	1600	MC-22b
7.5	15	18.5	7.5	15	18.5	1800	MC-32a
11	18.5	22	11	18.5	22	2000	MC-40a
15	22	30	15	22	30	2100	MC-50a
18.5	30	33	18.5	30	33	3000	MC-65a
22	37	37	22	37	37	3050	MC-75a
25	45	45	25	45	45	3050	MC-85a
25	45	50	25	45	50	3050	MC-100a

Note) Upper limit of temperature category conforming to IEC 60070

Selection and Application

2. Application

2.13 Capacitor Load Application

Capacitor switching unit

Because there is a very large (about 20 times the rating) rush current during condenser bank switching, the normal magnetic contactor will not last for its durability so apply a condenser unit by selecting proper operational magnetic contactor.

- Characteristic of condenser unit(pre-loading resistor attaching type unit)
 - 1) It consists of damping resistor which limits input current up to maximum $60I_n$ (60 times of rated current) and wire closed circuit.
 - 2) No heating loss by series resistance
 - 3) Removing switching surge
 - 4) Improving life span of capacitor system

This product is suitable for switching single-step or multi-step condenser bank.

- Related standard : IEC 60947-4-1, UL, CSA
- Product composition: magnetic contactor and condenser unit (Pre-loading resistance) are combined.
- Contact point composition : main contact 3 pole (3a), no standard sub-contact point
- Control power (coil) : AC50, 60 Hz or DC
- Installation : for both 35mm DIN rail and screw

Application capacitor power table

Type	Application condenser power (kvar)			Rated current (A)	Combined condenser unit
	220~240V	400~440V	600~690V		
MC-6a(D)	5	9	14	12	AC-9
MC-9a,b(D)	5	10	14	14	AC-9
MC-12a,b(D)	7	13	18	18	AC-9
MC-18a,b(D)	9	17	24	24	AC-9
MC-22b(D)	9	17	26	22	AC-9
MC-32a(D)	15	25	36	36	AC-9
MC-40a(D)	20	33	48	48	AC-9
MC-50a(D)	20	40	58	58	AC-50
MC-65a(D)	25	46	66	66	AC-50
MC-75a(D)	30	54	78	78	AC-50
MC-85a(D)	35	60	92	92	AC-50
MC-100a(D)	37	62	94	94	AC-50

Note) kVar rating from table can be applied to connecting wire Y of condenser.

Condenser should be discharged before recharging it after circuit closing the switch.

- maximum residual voltage of terminal < 50V gG type fuse which is 1.5~1.8 times of rating should be used for protecting short circuit.

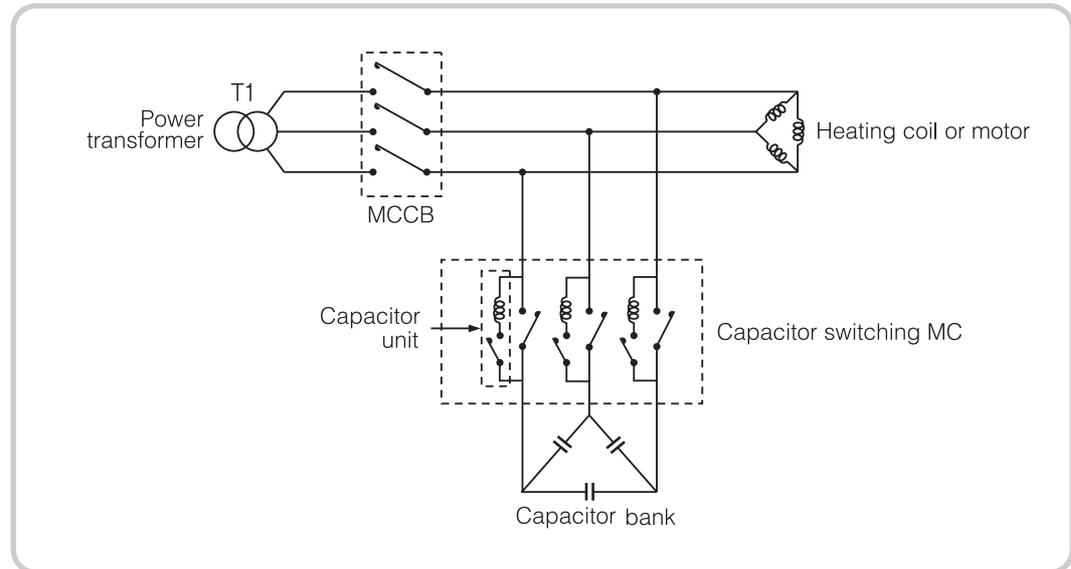

Fig. 40. Capacitor load application circuit

H

2.14 Lighting Circuit Selection Guid

Current peaks which happen during activation of lighting circuits and power factors depend on type, connection mode and compensation. For this application, IEC 947-4-1 regulates two standard utilization ranges.

- AC-5a for switching discharging lamps.
- AC-5b for switching incandescence lamps

Higher current than normal current(after lighting) flows when driving, in case of lighting loads of fluorescent lamps, mercury lamps, incandescent lamps.

- Fluorescent lamp: Approximately 10 times
- Mercury lamp: Approximately 2 times
- Incandescent lamp: Approximately 10 times

For making current closed in circuit when starting, and enduring until lighting time and with a certain amount of electrical durability, selection of contactor is determined as follows.

[total normal current of lighting load \leq AC3 class rated operational current of magnetic contactor] It is regulated with AC5a (switching control device such as discharging) AC5b (switching incandescent lamp) class for lighting load, but it can be replaced with rated performance of the AC3 class. Moreover, operation condition of lighting circuit has following characteristics.

- Continuous duty : Switching device can be input for several days or months.
- Index of dispersion for 1 : Every lighting device in same group becomes switch on or off simultaneously.
- Operation current for lighting is lower than given value about AC-1 duty, because of relatively higher temperature around the device by case, fuse, control panel location without ventilation.

Selection and Application

2. Application

2.14 Lighting Circuit Selection Guid

1. Protection

- Continuous current connected to lighting circuit is constant. Actually,
- Lighting circuit number of existing circuit doesn't really change.
 - This circuit type generates long-term overload.

Therefore, this circuit only requires short circuit protection, it can be provided with following.

- gG type fuse
- a miniature or modular circuit-breakers

But, it is possible and sometimes economical to protect circuit with an aM Type related with thermal overload relay (smaller cable size).

2. Distribution system

Single phase 220/ 240V

Previous tables (page 175 to 184) are based on single phase 220/240V circuits, therefore they can be directly applied in this case.

3. Three phase circuit 380/415V with neutral conductor

Total lamp number(N) is divided into 3 equivalent groups when simultaneous switching. Each one is connected between one phase and neutral conductor. Magnetic contactor can be selected from 220/240V single phase table about lamp number same as N / 3

4. Three phase circuit 220/240V

Total lamp number(N) is divided into 3 equivalent groups when simultaneous switching. Each one is connected between two phases, (L1-L2), (L2-L3), (L3-L1). Magnetic contactor can be selected from 220/240V single phase table about lamp number same as N

5. Contactor selection table

Table page 175 to 184 about various lamp types provide maximum number of device capacity P(watt) possible for switching to each size of magnetic contactor simultaneously. They are based on following.

- 1) 220/240V single phase circuit
- 2) Surrounding temperature 55°C with considering operation condition
- 3) Electrical life span more than 10 years(operating for 200 days per year)

They consider followings.

- 1) Entire current(including ballast)
- 2) Transient phenomena, when input
- 3) Clanking ampere and Circulation of every harmonic wave that period can be expressed.

6. Lamp with compensation capacity C(μF) connected in AC

Transient current flows when switch-on AC connecting capacitor, to guarantee of this transient current is compatible with closing characteristic, value of capacitor should not exceed the following.

This value is independent with switched lamp number with contactor.

- 1) lu multiplies 1.2 about surrounding temperature 40°C

Type name of contactors	18AF				22AF				40AF			65AF	
	6a	9a	12a	18a	9b	12b	18b	22b	25a	32a	40a	50a	65a
Max val. of compensating condenser C(μF)	14	18	18	25	18	18	25	96	60	96	120	120	240

Type name of contactors	100AF			150AF		225AF		400AF			800AF		
	75a	85a	100a	130a	150a	185a	225a	265a	330a	400a	500a	630a	800a
Max val. of compensating condenser C(μF)	240	240	240	300	360	800	1200	1700	2500	4000	6000	9000	9000

■ **Incandescent lamp**

The filament of an incandescent lamp has an especially small resistance at room temperature, a current of 3~16 times the rated current flows theoretically at the moment when voltage is applied, but transient current is restrained up to 7~10 times by circuit impedance or magnetic heating in practical conditions. A characteristic example is as follows at the moment from when voltage is applied to when the current is stable. The magnetic contactor applied to an incandescent lamp needs to be inserted while considering this transient current, the rated current of incandescent lamp should be selected within an AC3 class rated operational current.

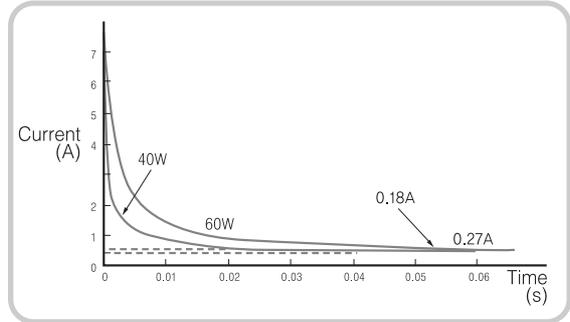

Fig. 41. Voltage applied instant' s current characteristic of 220V, 40W, 60W standard lamps

- IB: rated current value of each lamp at rated operation voltage
- C : device capacitance about each lamp, which is suitable for the value provided by usual lamp manufacturer. This value is given about surrounding temperature 55° C (lu multiplies 1.2 about 40° C)

1. Incandescent lamp, halogen lamp

unit : EA

P(W)	60	75	100	150	200	300	500	750	1000	Type name of contactor
IB(A)	0.27	0.34	0.45	0.68	0.91	1.36	2.27	3.41	4.55	
Maximum number of lamp according to P(W)	33	27	20	13	10	7	4	3	2	MC-6a
	37	29	22	15	11	7	4	3	2	MC-9a, 9b
	43	35	26	17	13	9	5	3	3	MC-12a, 12b
	60	48	36	24	18	12	7	5	4	MC-18a, 18b
	62	49	37	25	19	12	7	5	4	MC-22b
	87	69	52	35	26	17	10	7	5	MC-32a
	117	93	70	47	35	23	14	9	7	MC-40a
	167	133	100	67	50	33	20	13	10	MC-50a
	217	173	130	87	65	43	26	17	13	MC-65a
	250	200	150	100	75	50	30	20	15	MC-75a
	283	227	170	113	85	57	34	23	17	MC-85a
	317	253	190	127	95	63	38	25	19	MC-100a
	417	333	250	167	125	83	50	33	25	MC-130a
	467	373	280	187	140	93	56	37	28	MC-150a
	700	560	420	280	210	140	84	56	42	MC-185a
	767	613	460	307	230	153	92	61	46	MC-225a
	883	707	530	353	265	177	106	71	53	MC-265a
	1000	800	600	400	300	200	120	80	60	MC-330a
	1267	1013	760	507	380	253	152	101	76	MC-400a
1717	1373	1030	687	515	343	206	137	103	MC-500a	
2333	1867	1400	933	700	467	280	187	140	MC-630a	
3033	2427	1820	1213	910	607	364	243	182	MC-800a	

Selection and Application

2. Application

2.14 Lighting Circuit Selection Guid

■ Incandescent lamp

2. Mixed lighting

unit : EA

P(W)	100	160	250	500	1000	Type name of contactor
IB(A)	0.45	0.73	1.14	2.27	4.55	
Maximum number of lamp according to P(W)	20	13	8	4	2	MC-6a
	22	14	9	4	2	MC-9a, 9b
	26	16	10	5	3	MC-12a, 12b
	36	23	14	7	4	MC-18a, 18b
	37	23	15	7	4	MC-22b
	52	33	21	10	5	MC-32a
	70	44	28	14	7	MC-40a
	100	63	40	20	10	MC-50a
	130	81	52	26	13	MC-65a
	150	94	60	30	15	MC-75a
	170	106	68	34	17	MC-85a
	190	119	76	38	19	MC-100a
	250	156	100	50	25	MC-130a
	280	175	112	56	28	MC-150a
	420	263	168	84	42	MC-185a
	460	288	184	92	46	MC-225a
	530	331	212	106	53	MC-265a
	600	375	240	120	60	MC-330a
	760	475	304	152	76	MC-400a
	1030	644	412	206	103	MC-500a
1400	875	560	280	140	MC-630a	
1820	1138	728	364	182	MC-800a	

■ **Fluorescent lamp with starter**

The fluorescent lamp is used with a combination of a fluorescent lamp and ballast, and categorized according to starti starter or rapid starter. Starter type is a ballast which lights using manual switch operation or an automatic starter (groidely used in households. In contrast, rapid starter type lights distinctly differ from starter type, being a type without contact, widely used in buildings, plants, hospitals, schools. The clanking ampere of florescent lamps is different d whether there is a ballast circuit and condenser for controlling power factor or not, but it is recommended to selec contactor with less than AC3 class rated operational current, because it flows approximately 10 times of lamp current.

- IB: rated current value of each lamp at rated operation voltage
- C : Device capacitance about each lamp, which is suitable for the value provided by usual lamp manufacturer. This about surrounding temperature 55° C. (lu multiplies 1.2 about 40° C)

1. Single fitting

unit : EA

Type	Not compensated					With AC compensation (parallel connection)					Type name of contactor
P(W)	20	40	65	80	110	20	40	65	80	110	
IB(A)	0.39	0.45	0.70	0.80	1.20	0.17	0.26	0.42	0.52	0.72	
C(μF)	-	-	-	-	-	5	5	7	7	16	
Maximum number of lamp according to P(W)	24	21	13	12	8	56	36	22	18	-	MC-6a
	41	35	22	20	13	94	61	38	30	22	MC-9a,9b
	41	35	22	20	13	94	61	38	30	22	MC-12a,12b
	53	46	30	26	17	123	80	50	40	29	MC-18a,18b
	53	46	30	26	17	123	80	50	40	29	MC-22b
	89	77	50	43	29	205	134	83	67	48	MC-32a
	112	97	62	55	36	258	169	104	84	61	MC-40a
	143	124	80	70	46	329	215	133	107	77	MC-50a
	143	124	80	70	46	329	215	133	107	77	MC-65a
	205	177	114	100	66	470	367	190	153	111	MC-75a
	205	177	114	100	66	470	367	190	153	111	MC-85a
	205	177	114	100	66	470	367	190	153	111	MC-100a
	328	283	182	160	106	752	491	304	245	178	MC-130a
	410	354	228	200	132	940	614	380	306	222	MC-150a
	492	426	274	240	160	1128	738	456	368	266	MC-185a
	532	462	296	260	172	1224	800	490	400	288	MC-225a
	614	532	342	300	200	1412	922	570	462	332	MC-265a
	696	604	388	340	226	1600	1046	648	522	378	MC-330a
	882	764	490	430	286	2024	1322	818	662	478	MC-400a
	1190	1030	652	580	386	2728	1724	1104	892	644	MC-500a
1612	1398	698	786	524	3700	2418	1498	1210	874	MC-630a	
2096	1817	907	1022	681	4810	3143	1947	1573	1136	MC-800a	

Selection and Application

2. Application

2.14 Lighting Circuit Selection Guid

Fluorescent lamp with starter

2. Twin fitting

unit : EA

Type	Not compensated					With AC compensation (parallel connection)					Type name of contactor	
	P(W)	2x20	2x40	2x65	2x80	2x110	2x20	2x40	2x65	2x80		2x110
	IB(A)	2x0.22	2x0.41	2x0.67	2x0.82	2x1.1	2x0.13	2x0.24	2x0.39	2x0.48		2x0.65
Maximum number of lamp according to P(W)	2x21	2x11	2x7	2x5	2x4	2x36	2x20	2x12	2x10	2x7	MC-6a	
	2x36	2x18	2x10	2x8	2x6	2x60	2x32	2x20	2x16	2x12	MC-9a, 9b	
	2x36	2x18	2x10	2x8	2x6	2x60	2x32	2x20	2x16	2x12	MC-12a, 12b	
	2x46	2x24	2x14	2x12	2x8	2x80	2x42	2x26	2x20	2x16	MC-18a, 18b	
	2x46	2x24	2x14	2x12	2x8	2x80	2x42	2x26	2x20	2x16	MC-22b	
	2x78	2x42	2x26	2x20	2x14	2x134	2x72	2x44	2x36	2x26	MC-32a	
	2x100	2x52	2x32	2x26	2x15	2x168	2x90	2x56	2x44	2x32	MC-40a	
	2x126	2x68	2x40	2x34	2x24	2x214	2x116	2x70	2x58	2x42	MC-50a	
	2x126	2x68	2x40	2x34	2x24	2x214	2x116	2x70	2x58	2x42	MC-65a	
	2x180	2x96	2x58	2x48	2x36	2x306	2x166	2x102	2x82	2x60	MC-75a	
	2x180	2x96	2x58	2x48	2x36	2x306	2x166	2x102	2x82	2x60	MC-85a	
	2x180	2x96	2x58	2x48	2x36	2x306	2x166	2x102	2x82	2x60	MC-100a	
	2x380	2x194	2x118	2x96	2x72	2x614	2x332	2x204	2x166	2x122	MC-130a	
	-	-	-	-	-	-	-	-	-	-	-	MC-150a
	2x436	2x234	2x142	2x116	2x86	2x738	2x400	2x246	2x200	2x146	MC-185a	
	2x472	2x254	2x154	2x126	2x94	2x800	2x432	2x266	2x216	2x160	MC-225a	
	2x544	2x292	2x178	2x146	2x108	2x922	2x500	2x308	2x250	2x184	MC-265a	
	2x618	2x332	2x202	2x166	2x124	2x1046	2x566	2x348	2x282	2x208	MC-330a	
	2x782	2x420	2x256	2x210	2x156	2x1322	2x716	2x440	2x358	2x264	MC-400a	
	2x1054	2x566	2x346	2x282	2x210	2x1784	2x966	2x594	2x482	2x356	MC-500a	
2x1430	2x766	2x468	2x384	2x286	2x2418	2x1370	2x806	2x654	2x484	MC-630a		
2x1859	2x995	2x608	2x499	2x371	2x3143	2x1781	2x1047	2x850	2x629	MC-800a		

■ **Fluorescent lamp without starter**

- IB: Rated current value of each lamp at rated operation voltage
- IC: Device capacitance about each lamp, which is suitable for the value provided by usual lamp manufacturer. This value is given about surrounding temperature 55° C. (Iu multiplies 1.2 about 40° C)

1. Single fitting

unit : EA

Type	Notcompensated					With AC compensation (parallel connection)					Type name of contactor
	P(W)	40	65	80	110	20	40	65	80	110	
IB(A)	0.39	0.45	0.70	0.80	1.20	0.17	0.26	0.42	0.52	0.72	
C (μF)	-	-	-	-	-	5	5	7	7	16	
Maximum number of lamp according to P(W)	22	17	12	10	6	50	33	20	16	-	MC-6a
	37	29	20	16	11	84	55	34	28	20	MC-9a, 9b
	37	29	20	16	11	84	55	34	28	20	MC-12a, 12b
	48	38	26	22	15	110	72	45	36	26	MC-18a, 18b
	48	38	26	22	15	110	72	45	36	26	MC-22b
	97	63	43	36	25	184	101	76	61	44	MC-32a
	112	97	62	55	36	258	169	104	84	61	MC-40a
	130	101	70	58	40	294	193	121	98	70	MC-50a
	130	101	70	58	40	294	193	121	98	70	MC-65a
	186	145	100	84	57	421	275	173	140	101	MC-75a
	186	145	100	84	57	421	275	173	140	101	MC-85a
	186	145	100	84	57	421	275	173	140	101	MC-100a
	372	290	200	168	114	842	550	340	280	202	MC-130a
	410	320	221	186	120	929	609	383	309	223	MC-150a
	446	348	240	202	130	1010	662	416	336	242	MC-185a
	484	378	260	218	148	1094	716	452	364	262	MC-225a
	558	438	300	252	170	1252	828	522	420	304	MC-265a
	632	494	340	286	194	1462	936	590	476	344	MC-330a
800	524	430	362	246	1810	1186	748	604	434	MC-400a	
1078	844	580	488	330	2442	1600	1008	814	586	MC-500a	
1462	1144	786	662	448	3310	2168	1366	1104	796	MC-630a	
1901	1487	1022	861	582	4303	2818	1776	1435	1035	MC-800a	

Selection and Application

2. Application

2.14 Lighting Circuit Selection Guide

Fluorescent lamp without starter

2. Twin fitting

unit : EA

Type	Notcompensated					With AC compensation (series connection)					Type name of contactor
	P(W)	2x20	2x40	2x65	2x80	2x110	2x20	2x40	2x65	2x80	
IB(A)	2x0.22	2x0.41	2x0.67	2x0.82	2x1.1	2x0.13	2x9.24	2x0.39	2x0.48	2x65	
Maximum number of lamp according to P(W)	2x19	2x10	2x6	2x5	2x36	2x34	2x18	2x11	2x9	2x6	MC-6a
	2x32	2x16	2x10	2x8	2x6	2x56	2x30	2x18	2x14	2x10	MC-9a, 9b
	2x32	2x16	2x10	2x8	2x6	2x56	2x30	2x18	2x14	2x10	MC-12a, 12b
	2x42	2x22	2x12	2x10	2x8	2x74	2x40	2x24	2x18	2x14	MC-18a, 18b
	2x42	2x22	2x12	2x10	2x8	2x74	2x40	2x24	2x18	2x14	MC-22b
	2x70	2x36	2x22	2x18	2x12	2x124	2x66	2x40	2x32	2x24	MC-32a
	2x88	2x46	2x28	2x22	2x16	2x156	2x84	2x50	2x40	2x30	MC-40a
	2x112	2x58	2x36	2x30	2x20	2x200	2x106	2x64	2x52	2x38	MC-50a
	2x112	2x58	2x36	2x30	2x20	2x200	2x106	2x64	2x52	2x38	MC-65a
	2x160	2x84	2x52	2x42	2x30	2x234	2x152	2x92	2x74	2x54	MC-75a
	2x160	2x84	2x52	2x42	2x30	2x234	2x152	2x92	2x74	2x54	MC-85a
	2x160	2x84	2x52	2x42	2x30	2x234	2x152	2x92	2x74	2x54	MC-100a
	2x320	2x170	2x104	2x86	2x60	2x570	2x306	2x186	2x150	2x110	MC-130a
	2x353	2x187	2x115	2x93	2x68	2x631	2x338	2x204	2x165	2x121	MC-150a
	2x384	2x204	2x126	2x102	2x74	2x686	2x368	2x222	2x180	2x132	MC-185a
	2x416	2x220	2x136	2x112	2x80	2x742	2x400	2x242	2x196	2x144	MC-225a
	2x480	2x254	2x156	2x128	2x92	2x856	2x462	2x278	2x226	2x166	MC-265a
	2x544	2x288	2x178	2x146	2x104	2x970	2x522	2x316	2x256	2x188	MC-330a
	2x688	2x366	2x226	2x184	2x132	2x1228	2x662	2x400	2x324	2x238	MC-400a
	2x928	2x494	2x304	2x248	2x178	2x1656	2x892	2x540	2x438	2x322	MC-500a
2x1258	2x668	2x414	2x338	2x242	2x2246	2x1210	2x730	2x592	2x436	MC-630a	
2x1698	2x901	2x558	2x456	2x326	2x3032	2x1633	2x985	2x799	2x588	MC-800a	

■ Sodium vapor lamp

- IB: Rated current value of each lamp at rated operation voltage
- C : Device capacitance of each lamp, which is suitable for the value provided by the lamp manufacturer. This value is given for surrounding temperature 55 ° C.
(Iu multiplies 1.2 about 40 ° C)

1. Low pressure sodium vapor lamps

unit : EA

Type	Not compensated							With AC compensation (parallel connection)							Type name of contactor
P(W)	35	55	90	135	150	180	200	35	55	90	135	150	180	200	
IB(A)	1.2	1.6	2.4	3.1	3.2	3.3	3.4	0.3	0.4	0.6	0.9	1.0	1.2	1.3	
C (μF)	-	-	-	-	-	-	-	17	17	25	36	36	36	36	
Maximum number of lamp according to P(W)	6	5	3	2	2	2	2	-	-	-	-	-	-	-	MC-6a
	10	7	5	3	3	3	3	40	30	-	-	-	-	-	MC-9a, 9b
	10	7	5	3	3	3	3	40	30	-	-	-	-	-	MC-12a, 12b
	12	9	6	4	4	4	4	50	37	25	-	-	-	-	MC-18a, 18b
	12	9	6	4	4	4	4	50	37	25	-	-	-	-	MC-22b
	21	16	10	8	8	7	7	86	65	43	28	26	21	20	MC-32a
	27	20	13	10	10	10	9	110	82	55	36	33	27	25	MC-40a
	35	26	17	13	13	12	12	140	105	70	46	42	35	32	MC-50a
	35	26	17	13	13	12	12	140	105	70	46	42	35	32	MC-65a
	50	37	25	19	18	18	17	200	150	100	66	60	50	46	MC-75a
	50	37	25	19	18	18	17	200	150	100	66	60	50	46	MC-85a
	50	37	25	19	18	18	17	200	150	100	66	60	50	46	MC-100a
	100	75	50	38	36	36	34	400	300	200	132	120	100	92	MC-130a
	129	129	129	129	129	129	129	129	129	129	129	129	129	129	MC-150a
	140	104	70	54	52	50	48	560	420	280	186	168	140	128	MC-185a
	152	114	76	58	56	54	54	606	4545	302	202	182	152	140	MC-225a
	174	130	88	68	66	64	62	700	24	350	232	210	174	162	MC-265a
	198	148	98	76	74	72	70	792	594	396	264	238	198	182	MC-330a
	250	188	124	96	94	90	88	1002	752	502	334	300	250	208	MC-400a
	338	254	168	130	126	122	118	1352	1014	676	450	406	338	312	MC-500a
496	372	248	192	186	180	174	1982	1488	992	660	694	496	458	MC-630a	
724	543	362	280	272	263	254	2894	2172	1448	964	1013	724	669	MC-800a	

H

Selection and Application

2. Application

2.14 Lighting Circuit Selection Guide

■ Sodium vapor lamp

2. High pressure sodium vapor lamps

unit : EA

Type	Notcompensated					With AC compensation(parallel connection)					Type name of contactor
	P(W)	3.5	5.5	9.	135	150	35	55	90	135	
IB(A)	1.2	1.6	2.4	3.1	3.2	0.3	0.4	0.6	0.9	1.0	
C (μF)	-	-	-	-	-	17	17	25	36	36	
Maximum number of lamp according to P(W)	4	2	1	-	-	-	-	-	-	-	MC-6a
	6	3	2	1	-	-	-	-	-	-	MC-9a, 9b
	6	3	2	1	-	-	-	-	-	-	MC-12a, 12b
	7	4	3	1	1	17	-	-	-	-	MC-18a, 18b
	7	4	3	1	1	17	-	-	-	-	MC-22b
	13	8	5	2	2	30	18	11	6	-	MC-32a
	17	10	6	3	2	39	23	15	8	6	MC-40a
	22	13	8	4	3	50	30	19	10	7	MC-50a
	22	13	8	4	3	50	30	19	10	7	MC-65a
	31	18	12	6	4	71	42	27	15	10	MC-75a
	31	18	12	6	4	71	42	27	15	10	MC-85a
	31	18	12	6	4	71	42	27	15	10	MC-100a
	62	36	24	12	8	142	84	54	30	20	MC-130a
	81	48	31	17	13	184	110	70	39	28	MC-150a
	88	52	34	18	14	200	120	76	42	30	MC-185a
	96	56	36	20	16	216	130	82	46	32	MC-225a
	110	66	42	24	18	250	150	94	54	38	MC-265a
	124	74	48	26	20	282	170	108	60	42	MC-330a
	158	94	60	34	24	358	214	136	76	54	MC-400a
	214	126	80	46	32	482	290	184	104	74	MC-500a
312	186	118	68	48	708	424	270	152	108	MC-630a	
452	270	171	99	70	1027	615	392	220	157	MC-800a	

■ Mercury lamp

- IB: Rated current value of each lamp at rated operation voltage
- C : Device capacitance of each lamp, which is suitable for the value provided by the lamp manufacturer. This value is given for surrounding temperature 55°C. (lu multiplies 1.2 about 40°C)

1. High pressure mercury vapour lamp

unit : EA

Type	Not compensated							With AC compensation (parallel connection)							Type name of contactor
P(W)	50	80	125	250	400	700	1,000	35	55	90	135	150	180	200	
IB(A)	0.54	0.81	1.20	2.30	4.10	6.80	9.90	0.30	0.45	0.67	1.30	2.30	3.80	5.50	
C (μF)	-	-	-	-	-	-	-	10	10	10	18	25	40	60	
Maximum number of lamp according to P(W)	14	9	6	3	1	-	-	-	-	-	-	-	-	-	MC-6a
	22	14	9	5	2	1	1	40	26	17	9	-	-	-	MC-9a, 9b
	22	14	9	5	2	1	1	40	26	17	9	-	-	-	MC-12a, 12b
	27	18	12	6	3	2	1	50	33	22	11	6	-	-	MC-18a, 18b
	27	18	12	6	3	2	1	50	33	22	11	6	-	-	MC-22b
	48	32	21	11	6	3	2	86	57	38	20	11	6	4	MC-32a
	61	40	27	14	8	4	3	110	73	49	25	14	8	6	MC-40a
	77	51	34	17	10	6	4	140	93	62	32	18	11	7	MC-50a
	77	51	34	17	10	6	4	140	93	62	32	18	11	7	MC-65a
	111	74	49	26	14	8	6	200	133	89	46	26	15	10	MC-75a
	111	74	49	26	14	8	6	200	133	89	46	26	15	10	MC-85a
	111	74	49	26	14	8	6	200	133	89	46	26	15	10	MC-100a
	222	146	100	52	28	16	12	400	266	178	92	52	30	20	MC-130a
	285	190	129	66	37	22	16	515	342	230	118	66	40	28	MC-150a
	310	206	140	72	40	24	17	560	372	250	128	72	44	30	MC-185a
	336	224	152	78	44	26	18	606	404	272	140	78	48	32	MC-225a
	388	258	174	90	50	30	20	700	466	312	162	90	54	38	MC-265a
	440	294	198	102	58	34	24	792	528	354	182	102	62	42	MC-330a
	556	372	250	130	72	44	30	1002	668	448	232	130	78	54	MC-400a
	752	500	338	176	96	60	40	1352	902	606	312	176	106	74	MC-500a
1102	734	496	258	144	88	60	1982	1322	888	458	258	156	108	MC-630a	
1609	1072	724	377	210	128	88	2894	1930	1296	669	377	228	158	MC-800a	

H

Selection and Application

2. Application

2.14 Lighting Circuit Selection Guid

Mercury lamp

2. Metal Iodine vapour lamp

unit : EA

Type	Not compensated				With AC compensation(parallel connection)				Type name of contactor
	P(W)	35	55	90	150	35	55	90	
IB(A)	1.2	1.6	2.4	3.2	0.3	0.4	0.6	1.0	
C(μF)	-	-	-	-	17	17	25	36	
Maximum number of lamp according to P(W)	3	2	-	-	-	-	-	-	MC-6a
	4	3	1	-	-	-	-	-	MC-9a, 9b
	4	3	1	-	-	-	-	-	MC-12a, 12b
	6	4	1	-	-	-	-	-	MC-18a, 18b
	6	4	1	-	-	-	-	-	MC-22b
	10	7	2	1	18	13	4	-	MC-32a
	13	9	3	1	23	16	6	-	MC-40a
	16	11	4	2	30	21	7	-	MC-50a
	16	11	4	2	30	21	7	-	MC-65a
	24	16	6	3	42	30	11	5	MC-75a
	24	16	6	3	42	30	11	5	MC-85a
	24	16	6	3	42	30	11	5	MC-100a
	48	32	12	6	84	60	22	10	MC-130a
	61	42	17	7	110	77	29	13	MC-150a
	66	46	18	8	120	84	32	14	MC-185a
	72	50	20	10	130	90	34	16	MC-225a
	84	58	22	12	150	104	40	18	MC-265a
	94	66	24	14	170	118	44	20	MC-330a
	120	84	32	16	214	150	56	26	MC-400a
	162	112	42	20	290	202	76	36	MC-500a
238	164	62	30	424	298	112	52	MC-630a	
347	239	91	44	619	435	164	76	MC-800a	

2.15 Heating Circuit

A thermal circuit is a power switching circuit providing more than one resistance element by magnetic contactor. The same general regulations are applied to an electric motor circuit, but a heating circuit requires only the provision of short-circuit protection, because it normally excludes condition of overload current.

Characteristics of heating elements

The following examples are based on resistance heating element used for industrial furnace and heating building (infrared ray or resistance radiation type, magnetic contactor heater and making loop thermal circuit etc.) Shift of resistance value causes current peak at switch-on which doesn't exceed 2 to 3 times of operating current between hot and cold condition. This initial peak doesn't happen again during normal operation of automatic temperature control in switching. Rated capacity and current of heater are given about normal operating temperature.

Protection

Stabilized current by the heating circuit is constant, when voltage is stabilized. Specifically,

- Load number at existing circuit is not altered well.
- This type of circuit can not generate overload.

Therefore, it is necessary to select among followings for providing short-circuit protection.

- G type fuse or
- Modular circuit breakers

However, it is always possible to protect circuit with aM type fuse related to thermal overload relay, sometimes it is more economical.(smaller cable size)

Switching, control, protection

Heating element group of given power or heating element is probably single phase or 3 phases, it can be provided at 220/127V or 400/230V power distribution system. Excluding single phase 127V system (which is no longer commonly used), it is possible to arrange following 3 circuits.

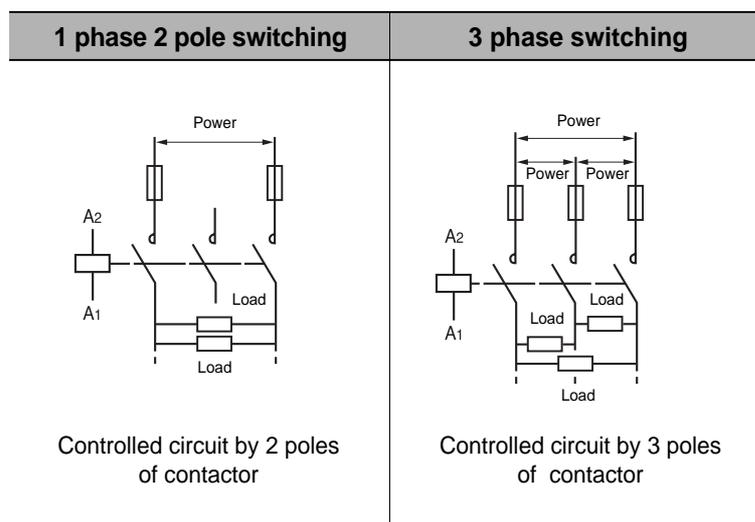

Selection and Application

2. Application

2.15 Heating Circuit

Component selection according to switching power

The following table has a standard with surrounding temperature 55°C. But, it is guaranteed to switch overloads extending to 1.05 of rated voltage, when it's applied with single phase.

1. Single phase 2 pole switching

Maximum power(kW)				Contactor	Application example
220/240V	380/415V	660/690V	1000V		
3	5.5	9.5	–	MC-6a	Single phase circuit providing total heating load of 12.5kW about 220V, 60Hz. Selection : 3 pole contactor MC-65a
4	7	12	–	MC-9a, 9b, 12a, 12b	
5	9.0	15.5	–	MC-18a, 18b, 22b	
9	15.0	25.5	–	MC-32a	
11	19	33	40	MC-40a	
14	24.0	41.5	57.0	MC-50a, 65a	
20	35	61	69	MC-75a, 85a, 100a	
44	76	118	157	MC-130a, 150a	
48	83	130	170	MC-185a	
52	90	145	185	MC-225a	
80	104	160	210	MC-265a	
75	130	200	250	MC-330a	
86	145	230	300	MC-400a	
116	200	310	400	MC-500a	
155	268	415	536	MC-630a	
225	389	602	777	MC-800a	

2. 3 phase switching

Maximum power(kW)				Contactor	Application example
220/240V	380/415V	660/690V	1000V		
4.5	8	13.5	–	MC-6a	Single phase circuit providing total heating load of 18kW about 220V, 60Hz. Selection : 3 pole contactor MC- 40a
6	11	21	–	MC-9a, 9b, 12a, 12b	
8	15.5	27.0	–	MC-18a, 18b, 22b	
15	26.0	44.0	–	MC-32a	
19	32	57	65	MC-40a	
24	41.0	72.0	94.0	MC-50a, 65a	
34	59	105	113	MC-75a, 85a, 100a	
76	131	206	275	MC-130a, 150a	
82	143	220	295	MC-185a	
90	155	250	320	MC-225a	
103	179	275	370	MC-265a	
130	225	345	432	MC-330a	
149	256	395	525	MC-400a	
200	346	530	710	MC-500a	
268	464	710	951	MC-630a	
389	672	1030	1380	MC-800a	

2.16 Switching the primaries of 3 phase LV/ LV transformers

An extremely large amount of transient rush current flows when connecting transformer to circuit. Twice as much magnetic flux of a normal state needs to flow in order to generate the induced voltage required according to the closing phase of exciting current, rush current to transformer becomes approximately 20~30 times of transformer's rated current for general saturation state with large amount of exciting current in this case.

Peak by magnetization should be considered when flowing current; IEC 947-4-1 regulates application range AC-6a for this application. AC-3 or AC-4 category test is applied for allowable operating current and capacity about magnetic contactor, and it is determined by calculating given formula from IEC 947-4-1 (Table VII b).

- Operating condition** | Maximum ambient temperature : 55° C
 initial current surge is generated normally which momentarily reaches peak value during switch-on of transformer, it decreases rapidly as stabilized state value.

- Selection of contactors** | Peak magnetising current of transformer must be lower than given value from the table below. following table shows operating capacity about maximum switching frequency of 60 operating cycles per hour.

Type name of contactors		18AF				22AF				40AF		65AF	
		6a	9a	12a	18a	9b	12b	18b	22b	32a	40a	50a	65a
Closing maximum operational power [kVA]	220/240V	2	3	4	5	3	4	5	6.1	8.5	16	16	18
	380/400V	3.3	5	6.7	8.4	5	6.7	8.4	10.2	15	27	27	31
	415/440V	3.7	5.5	7.3	9.2	5.5	7.3	9.2	11.2	17	32	32	36
	500V	4.2	6.2	8.3	10.4	6.2	8.3	10.4	12.8	20	36	36	40
	600/690V	5.7	8.6	11.5	14.4	8.6	11.5	14.4	17.6	26.5	48	48	53
Maximum permissible closing peak current [A]		160	350	350	420	350	350	420	420	770	1250	1250	1400

Type name of contactors		100AF			150AF		225AF		400AF			800AF		
		75a	85a	100a	130a	150a	185a	225a	265a	330a	400a	500a	630a	800a
Closing maximum operational power [kVA]	220/240V	18.1	19.3	24.1	31.3	31.3	40	45.8	50.7	64.5	74.8	99.8	114.7	179.6
	380/400V	30.1	32.1	40.2	52.2	52.2	66.6	76.4	84.5	112	130.3	166.3	191.2	288.2
	415/440V	33.2	35.4	44.2	57.5	57.5	73.3	84	92.9	123.2	149.4	182.9	210.3	323.1
	500V	37.7	40.2	50.2	65.3	65.3	83.3	95.5	105.6	140	169.7	207.8	249.4	367.2
	600/690V	52	55.5	69.3	90.1	90.1	115	131.8	142.5	173.5	200.8	268.9	329.9	411.1
Maximum permissible closing peak current [A]		1400	1550	1650	1800	2000	2900	3300	3800	5000	6300	7700	9000	12000

Note 1) Please select a magnetic contactor with the current less than 10 times of rated operational current, when rush current of transformer exceeds 20 times of it. On the contrary, when the rush current is less than 20 times smaller, you can use a contactor with a slightly larger amount of capacity than the value from upper table.

Note 2) Electrical durability is 500,000 cycles.

Selection and Application

2. Application

2.17 Influence of Conductors Length Used in Contactor Control Unit

Excess length of control circuit conductor under specific condition may interfere with execution of magnetic contactor's closing and breaking.

- Impossible closing: due to excessive voltage decrease (AC, DC)
- Impossible breaking: due to excessive capacitance (AC)

■ Permissible disconnection length of control circuit conductor in closing contactor.

First case: closing (Magnetic contactor with AC or DC control circuit)

Voltage drop is caused by rush current (inrush power) and resistance of control circuit conductor. Table and graph below can be used for determining disconnection length (distance between the control device and magnetic contactor coil) of line related with following.

- Closing coil consumption
- Supply voltage
- Sectional area of connecting line

This graph is about maximum line voltage decrease of 5%. Coil closing consumption power

Type	AC coil control circuit		DC coil control circuit	
	Applied contactor	Closing consumption powe (50/60Hz)	Applied contactor	Closing consumption powe (50/60Hz)
18AF	6a, 9a, 12a, 18a	80 VA	6a, 9a, 12a, 18a	3 W
22AF	9b, 12b, 18b, 22b	80 VA	9b, 12b, 18b, 22b	3 W
40AF	32a, 40a	80 VA	32a, 40a	2.2 W
65AF	50a, 65a	120 VA	50a, 65a	2.2 W
100AF	75a, 85a, 100a	220 VA	75a, 85a, 100a	5.1 W

It changes depending on service voltage, control circuit conductor's sectional area, and closing consumption power.

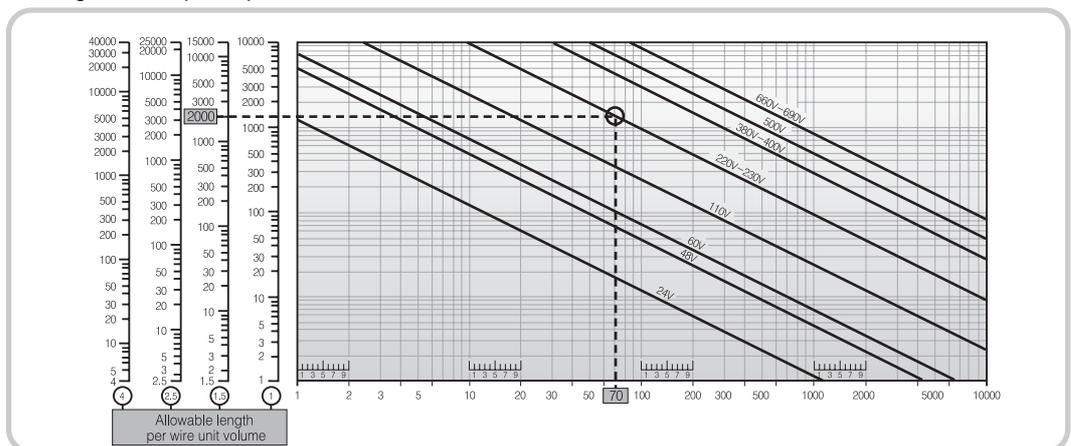

<Example : MC-9a magnetic contactor>

Coil voltage : 230V 50Hz, magnetic contactor coil closing power consumption : 70VA,

Control circuit conductors sectional area : Cu 1.5mm²

Maximum permissible length : 2000m

■ Permissible disconnection length of control circuit conductor in a breaking contactor

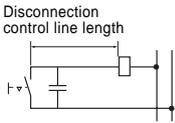

Wiring diagram A
Retained push button and 2-core cable
(ex: capacity 0.2μF/km)

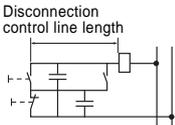

Wiring diagram B
Instant push button, holding contact and 3-core cable
(ex: capacity 2 X 0.2 = 0.4μF/km)

<example>
MC-18a magnetic contactor
Coil voltage $U_c=500V$, 50Hz, 8VA magnetic contactor coil maintaining consumption, control type: 2-core cable with capacity of 0.2mF /km and diagram A through kept push button
Maximum allowable length: 60m
MC-50a magnetic contactor
Coil voltage $U_c=230V$, 50Hz, 18VA magnetic contactor coil maintaining consumption, control type: 3-core cable with capacity of 2x0.2mF/km= 0.4 mF/km and holding contact. diagram B through kept instant push button
Maximum allowable length: 380m

Second case: breaking (conductor with AC control circuit)
AC operating magnetic contactor under specific condition doesn't break, when control circuit is inactivated. This is due to magnetic contactor's coil control lay-out type and extremely long control circuit line.(refers to diagram A, B)

This can be caused by following elements.

- High control voltage
- Low coil holding
- low stand-off voltage of magnetic contactor (according to IEC 947-4-1: 0.75xUc at 0.2)

Following preparation should be required, when demanding longer line.

- Select higher rated magnetic contactor
- Select lower control voltage
- Connect "p" impedance in parallel with magnetic contactor' s coil.

- value of parallel resistance : $R_p = \frac{10^2}{C}$ (C= μF)

Following table and graph can be used for determining single length of line(distance between control device and magnetic contactor coil)

- Coil holding consumption VA
- Service voltage
- Capacity(μF/km) (according to control lay-out)
- Power distribution diagram A, B shows examples of 2 services and coil control distribution.

Coil holding consumption power(average value)

Type	Applied contactor	Coil holding consumption power (50/60Hz)
18AF	6a, 9a, 12a, 18a	11 VA
22AF	9b, 12b, 18b, 22b	11 VA
40AF	32a, 40a	9 VA
65AF	50a, 65a	11 VA
100AF	75a, 85a, 100a	16 VA

It is different depending on capacity of control circuit magnetic contactor, voltage and coil holding consumption power.

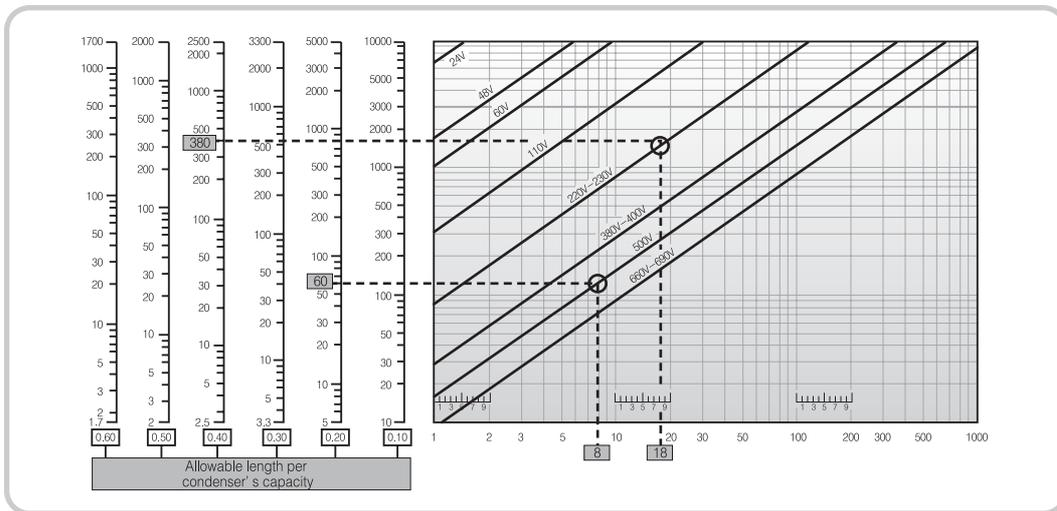

Selection and Application

2. Application

2.18 Selection of Transformer Power for Operation

Operating transformer power for magnetic contactor is selected by following :

1. Transformer's power = operating magnetic coil normal VA x (1.5~2.5)
2. In case of plural magnetic contactors with transformers load
 - 1) In the case of simultaneous closing power transformer
transformer power = sum of full load normal VA x (1.3~1.7)
 - 2) In case of simultaneous closing 2/3rd of transformer load(VA)
transformer power = sum of full load normal VA x (1.2~1.5)
 - 3) In case of simultaneous closing less than 1/2nd of transformer load(VA)
transformer power = sum of full load normal VA x (1~1.3)
3. Voltage decrease by connecting cable of operating circuit must be considered in case of selecting a transformer for operation.
4. Standard of transformer power is as following table, when connecting cable is short between operating transformer and magnetic contactor.
(Less than 1m, more than 1.25mm² thick)

Frame	Metasol series MC	
	Operating coil normal VA	Operating transformer capacity(VA)
18AF	9.5	15~25
22AF	9.5	15~25
40AF	9	15~25
65AF	11	20~30
100AF	16	25~40
150AF	24	75~100
225AF	40	100~150
400AF	50	100~150
800AF	90	100~150

I. Starting Method and Selection

1. Starting Method and Selection ----- 192
2. Star Delta Starting Method ----- 201

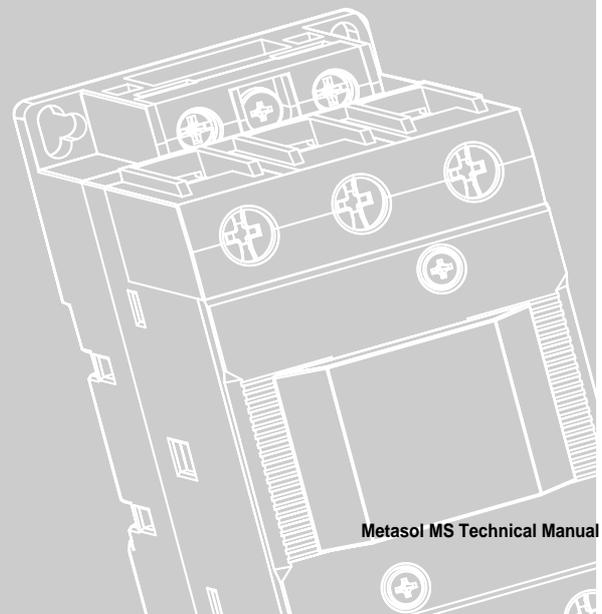

Starting Method and Selection

1. Starting Method and Selection

1.1 Types of Starting Method Schemes

Starting types of squirrel-cage induction motors can be classified like this according to magnetic contactor.

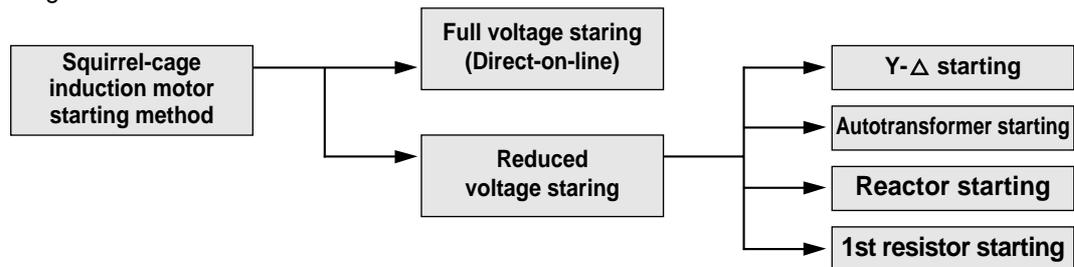

■ When reduced voltage startup is required

Shock on the machine can cause problems during starting because squirrel-cage induction motors start under a large electric current (about 5~8 times of the rated electric current) and not having starting torque control during full voltage start up is economical. Reduced voltage start up has removed this weakness, and there are 2 kinds which are reducing starting electric currents and controlling starting torque, star delta start up & autotransformer start up are near to the former and reactor start up and 1st resistor start up close to latter.

■ Y-Δ starting

Star delta start up is the cheapest type among reduced voltage start ups, and it can be applied to motors over 5.5W. But there are problems of starting with a load rising from fixed but can not be adjusted starting currents and torques and great shock during switch from star to delta because of open transition. Additionally there is a developed method called closed transition which involves inserting a resistor during the switch from star to delta, this can be replaced with an autotransformer start up by its merits of lowering generator' s capacity in the use of power from an emergency generator because of small rush current during transition.

■ Auto transformer starting

Generally autotransformer start up is composed of 3 taps of 80-65-50% onto the autotransformer as start up torque adjuster, there is little shock due to closed transition because winding at the autotransformer performs the reactor's role during transition. However it is not suitable for a very small capacity motor due to it's high price. It is the best starting method for starting from a small capacity generator.

■ Reactor starting

Reactor start up is adopted for delayed start up through an adjusted start up torque because starting current does not decrease (proportionally to the authorized voltage) compared with torque reduction (proportionate to the double multiplication of authorized voltage). This start up increases voltage applied to the motor with acceleration of rev up (reduction of starting current) and naturally torque will go up, and as there is almost no shock during transition, it will be the best start up in case load is big to be proportionate with rev up increase and load which is not adequate with shock during transition due to late start up. This start up is often used for thread winding in the spinning machine.

■ First resistor starting

1st Resistor start up uses a resistor instead of reactor in the reactor start up, there is no difference functionally from a reactor start up, but it is very difficult to create a big capacity due to resistor's restriction.

Table 1. Start up types and characteristics of the squirrel cage induction motor

Operation Method Type	Circuit diagram	Current characteristics (line current)	Torque curve characteristics	Acceleration	Price	Application
Fullvoltage (linestarting)		 $I_s : 100\%$	 $T_s : 100\%$	Torque increase : big Shock while starting: big	Cheap	Mostly used as long as power capacity is available. Economic choice (linestarting) 220V class 2.2~7kW 380V 3.7~150kW
Stardelta starting (Open transition)		 $I_1 = I_s \times 1/3 : 33\%$	 $T_1 = T_s \times 1/3 : 33\%$	Torque increase : small Max. torque: small	The cheapest choice at reduced voltage starting	Load free or light load operation more than 5kw. For machine tool, pump etc. 220V class 5.5~160kW 380V class 11~300kW
Stardelta starting (Close transition)		 $I_1 = I_s \times 1/3 : 33\%$	 $T_1 = T_s \times 1/3 : 33\%$	Torque increase : small Max. torque: small Shock during transition to delta : small	A little bit higher than open transition	Some kind of start up with load more than 5kW such as hydrant, sprinkler etc. 220V class 5.5~90kW 380V class 11~110kW
Reactor starting	 Reactor Tap : 50 - 60 - 70 - 80 - 90%	 $I_2 = I_s \times \left(\frac{V_1}{V}\right)^2$: 50 - 60 - 70 - 80 - 90%	 $T_2 = T_s \times \left(\frac{V_1}{V}\right)^2$: 25 - 36 - 49 - 64 - 81%	Torque increase : small Max. torque : small Smooth acceleration	Somewhat high	Load of two tier reduced torque such as blower and pump. Start up for spinning machine 220v 5.5~7.5kW 380v class 11~150kW
Auto transformer starting	 autotransformer Tap : 50 - 65 - 85%	 $I_3 = I_s \times \left(\frac{V_1}{V}\right)^2$: 64 - 42 - 25%	 $T_3 = T_s \times \left(\frac{V_1}{V}\right)^2$: 64 - 42 - 25%	Torque increase : a little bit small Max. torque : a little bit small Smooth acceleration	High	Especially for suppression of minimum running current. rack pump, blower, centrifuge 220v class 11~7.5kW 380V 22~150kW
1st reactor starting		 $I_4 = I_s \times \left(\frac{V_1}{V}\right)^2$: 75 ~ 90%	 $T_4 = T_s \times \left(\frac{V_1}{V}\right)^2$: 56 ~ 81%	Torque increase : big Max. torque : big Smooth acceleration	Somewhat high	Small Appliance (under 7.5kW) fan, pump, blower

Note) V : voltage V1 : motorterminal voltage Is : line starting current Ts : linestartingtorque I1~I4 : starting current against line starting T1~T4:starting torque against line starting

Starting Method and Selection

1. Starting Method and Selection

1.2 Starting Method Selection

Though start up of squirrel-cage induction motor is generally used for the no restriction on the starting current and cheap full voltage start using electro magnetic switch, but it can have problems of such as voltage lowering rapidly, damage to the other machine, and no operation if you start with full voltage in case of small capacity on the power transformer or cable. You need to choose how to start after reviewing following 4 things.

1. Impact on appliance due to voltage reduction at starting.
2. Checking motor torque against load torque
3. Checking time resistance quantity of the motor and starter
4. General review on the total installation cost

Impact of voltage fluctuation on appliances

Ideal power distribution is supplying power all over in the system, when voltage at terminal becomes too different from the rated value, then its function can vary as in table 2.

Table 2. Function change according to voltage change

Device	Characteristic	Voltage	
		90%	110%
Motor	Circuit(%)	- 19	+21
	Current(%)	+11	- 7
	Slip(%)	+23	-17
	Temperature rise(°C[K])	+ (6 ~7)	- (3 ~4)
Magnetic Appliance	Magnetic current (%)	- 10	+10
	Temperature rise at magnetic coil(°C[K])	- (10~20)	+ (8~20)
	Mechanical switching durability(%)	+30	-50
	Other	Magnet chattering under 85%	-
Lighting Appliance	Light flux(%)	-30	+30
	Endurance(%)	+30	- 50

Though 15% of voltage reduction is generally allowed at the terminal part in the appliance, the power voltage has a limit as seen in the following table 3, by the internal wire regulation and recommendation of electric power company.

Table 3. Permissible voltage fluctuation (recommended value)

Frequency of power fluctuation	Application	Permissible power fluctuation	
		Ordinary building	Factory
Minimal	Continuous operation pump etc.	6%	8%
Average	General machine tools etc.	4%	6%
Frequent	Elevator etc.	2%	4%
Very frequent	Welding machine etc.	-	3%

If voltage frequency rate far exceeds that specified in table 3, after checking the approximate rate using formula of voltage reduction rate(%), you need to control starting current through starter voltage reduction or consider another circuit which is using transformer bank-belonging to the load causing voltage reduction-temporarily or constantly separately with certain bank of control circuit and lighting load. You should consider voltage reduction by wire.

$$E(\%) = \%Z \times \frac{P_M}{P_T} = \%Z \times \frac{\sqrt{3}V}{P_T}$$

- E* : Rate of power reduction(%)
- %Z* : Impedance percent of transformer(generally 3~5%)
- P_T* : Capacity of transformer(kVA)
- P_M* : Input at the motor starting(kVA)
- V* : Voltage at terminal of the motor(V)
- I* : Line starting current(A)

In case other loads are coupled on the same transformer:

$$P_M = P_{M1} + P_{M2} + P_{M3}$$

■ Check motor torque against the load torque

If you start with reduced voltage because motor torque is proportionate to the double multiplication of phase voltage, accelerated torque dwindles greatly as shown in table 1. So load resistance torque is equal or almost equal to motor torque under full voltage speed as shown in fig 42. You cannot accelerate more because the motor will lose speed at point S. If this endures, you need to check for a burnout problem rising from rapidly overheated motor because continuous operating current is I₂ bigger than I₁ runs for a long time. Especially you need to be cautious of load torque before using it at star delta start up because load torque decrease as low as 33% of full voltage start up. For your reference, there are descriptions of requiring motor torque according to its operational, but it is ideal to pick up motor and starter after acquiring torque curve of the object machine.

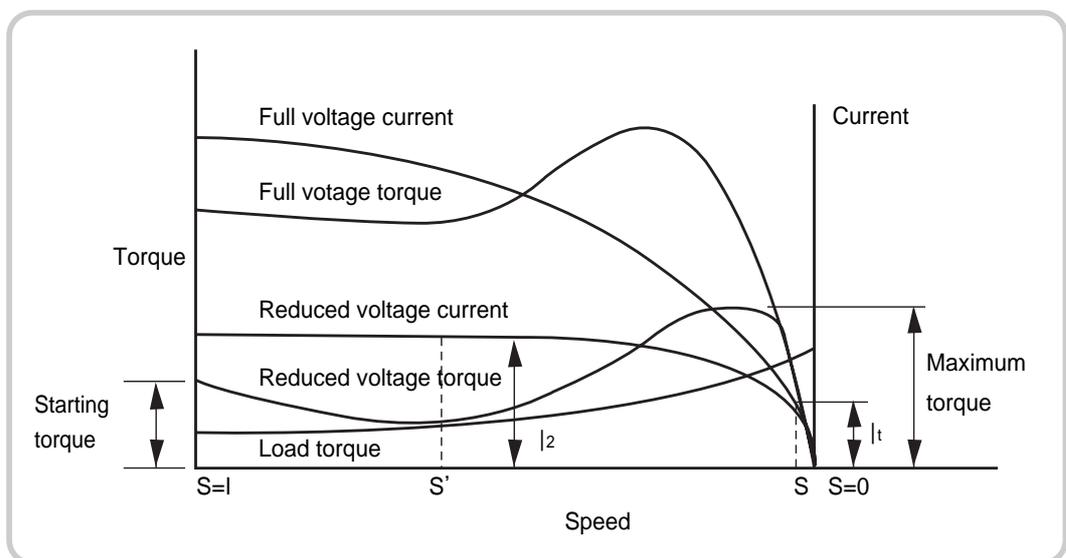

Fig. 42. Current characteristic curve of the motor torque

Starting Method and Selection

1. Starting Method and Selection

1.2 Starting Method Selection

■ Check motor torque against load torque

Table 4. Required motor torque by application(for reference)

Application	Required motor torque(%)		Application	Required motor torque(%)	
	Starting torque	Maximum torque		Starting torque	Maximum torque
Fan	30	150	Mill machine	100	175
Pump	40	150	Ball mixer (coal, rock)	140	175
Reciprocating pump(3cylinder)	150	150	Ball mixer (mineral)	150	175
Vacuum pump(Hytor type)	60	150	Grinder	50	150
Vacuum pump(reciprocating type)	40	150	AC generator	20	150
Centrifugal blower	30	150	DCgenerator	20	200
Centrifugal	30	150	Former	125	250
Crusher	100~150	250	Construction mixer	125	250

■ Check for time limit quantity of motor and starter

You need to check if time endurance of the motor and starter is sufficient because starting time gets longer though accelerating torque is reducing in the reduced voltage starter. You can get the starting time in the below formula. As T_a (average accelerating torque) is decreasing by the reduced voltage start up in case of reduced voltage start up, the starting time gets longer.

$$t = \frac{GD^2 T(N_2 \cdot N_1)}{375 \times T_a} = \frac{GD^2 T(N_2 \cdot N_1)}{375 \times \left[\frac{(T_s + T_m)}{2} - T_l \right]} = \frac{9.8}{375} \times GD^2 T \times \frac{(N_2 \cdot N_1)}{(T_s + T_l)}$$

t : starting time (sec)

$GD^2 T$: (moment of inertia at motor)+(load inertia moment of motor axis conversion)(kg · m²)

N_1 : initial revolution speed (rpm)

N_2 : last starting revolving speed (rpm)

T_a : Average accelerating speed of motor (kg · m)

generally $T_a \cong \frac{(T_s + T_m)}{2}$

T_s : starting torque (kg · m)

T_m : finishing torque (kg · m)

T_l : load resistance torque (kg · m)

For example, when accelerating torque reduced as 60% of the 100 % of the rated torque, if we put starting time at the full voltage as T_1 , then starting time of reduced voltage start up will be $T_2 = \frac{1}{0.6} \cong 1.7$ and it needs 1.7 times of time compared with full voltage start up.

Regarding the restrictions on the starting time at the reduced voltage starter, there are two points of over current endurance during short time at the starting contactor and reactor of autotransformer and malfunction on the TOR. On the over current endurance at the contactor, you need to review star contactor at the star delta starter. When you choose frame size of the contactor, please make it bottom line which can endure 20~30 seconds in respect of economic and practical condition on the over current endurance of the star contactor. This restricting time of star delta starter made from over current endurance of the contactor can be applied onto the starting of the reactor and autotransformer start up.

In case of reactor and autotransformer start up, it will be restricted under time rating by the temperature rise at the reactor & autotransformer which are used. This temperature rise can endure 3 times of approximate starting time sought from below formula by running 3 times of rated current after connecting induced loads on the 65% tap.(But it will be 2 times of starting time which is over 37kw as rated capacity)

$$t = 4 + 2\sqrt{P}$$

t : starting time (sec)

P : rated power of motor(kW)

As reactor and autotransformer are generally designed for 60 seconds rating regardless above condition & applied output, if starting time and accumulated continuous starting time goes over 60 seconds or starting is made more than once within 2 hours in case that temperature of reactor and autotransformer goes down to the room temperature in 2 hours after finishing starting cycle, you can not use standard product and instead you should use specially designed reactor and autotransformer having large time rating. In regards to malfunction of the tor, if you use automatic only for each class, then you can prevent malfunction for 6~20 seconds. Even though special design can be made for the ultimate long starting time more than 20 seconds, you need to prepare for short circuit of TOR heater during starting time or each TOR for the starting and operating. Additionally you need to enlarge heating capacity at magnetic contactor and contact conductor in case starting current is too long.

1.3 Squirrel-cage Induction Motor's Inrush Current

Though starting current at the squirrel cage induction motor reaches 5~6 times compared with normal rating current, it can be 6~12.5 times by the impact of magnetic saturation and input phase. You need to note carefully malfunctions at over current relay and distribution circuit breaker rising from big rush current like table5 due to remaining magnetism of motor which is rising when power is instantly disconnected with motor such as re input at stoppage, input on delta at the start delta start up (open transition), and antiphase damping.

Table 5. Rush current at the induction motor

Motor status		During start up	Reclosing during revolution (instant stoppage)	Antiphase damping
Item				
Starting current(antiphase current)		(5~6) Im	(5~6) Im	(5.5~7) Im ^{Note2)}
Magnetic saturation		1.2 ~ 1.3	1.2 ~ 1.3	1.2 ~ 1.3
Effect of remaining magnetism		Almost no problem	1~2	1~2
Effect of closed phase(L/R circuit)		1~1.6	1~1.6	1~1.6
Inrush current (effective value)	Minimum	(6~7.2) Im	(6~7.2) Im	(6.6~8.4) Im
	Maximum	(10.4~12.5) Im ^{Note1)}	(20.8~25) Im	(22.9~29.1) Im
Real value measured by LSIS		11.9 Im	19 Im	28.8 Im

Note 1) Possibility is small even in the worst case.

Note 2) $S=2$ and from the relation which becomes antiphase current $I_{sm} = \frac{E}{(r_1 + \frac{r_2}{2}) + j(x_1 + x_2)}$ is slightly bigger than the starting current.

Note 3) I_m =rated current of motor

Starting Method and Selection

1. Starting Method and Selection

1.4 How to Choose Contactors Based on Starting Type

You need to check following things in choosing contactor for starter.

1. Closed circuit and breaking capacity
2. Applied electric current or over current capacity during a short time.
3. Endurance (switching durability)
4. Extra time without current flow during converting
5. Voltage drop

Required functions of contactor used for various starting method

You can get a numeric value from table 6 if you calculate the required current flow capacity and closed isolation capacity of the magnetic contactor used for various start up at table 1.

Table 6. Required closed isolation & current flow capacity to the contactors used for various starting method.

Starting method	Tap value (%)	Making current	Breaking current	capacity		Available contactor (motor kW ratio)			
				Thermal current (Ith)	time	Selected making and breaking capacity (In case MC at category AC3)	Selected thermal current (Ith) capacity	Total category AC3	
Line starting	MC	-	6	1(6)	1	Continuous	1	1	1
	Stardelta	-	2	0.8(2)	2	Short time	0.33	0.33	0.33
	starting open	-	1.4(3.5)	0.58(3.5)	0.58	Continuous	0.58	0.58	0.58
	transition	-	2	0.58(3.5)	0.58	Continuous	0.58	0.58	0.58
Stardelta starting open transition	MCS ₁	-	-	0.8(2)	2	Short time	0.33	0.33	0.33
	MCS ₂	-	1.6	-	1.6	Very short time	0.2	0.2	0.2
	MCM	2	0.58(3.5)	0.58	Continuous	0.58	0.58	0.58	0.58
	MCD	-	1.4(3.5)	0.58(3.5)	0.58	Continuous	0.58	0.58	0.58
Autotransformer starting	MCS	50	1.5	-	1.5	Short time	0.23	0.2-0.3	0.6
		65	2.6	-	2.6		0.39	0.33-0.5	
		80	3.9	-	3.9		0.58	0.5-0.8	
	MCN	50	-	0.6(1.5)	1.5	Short time	0.29	0.2-0.3	0.3
		65	-	0.55(1.4)	1.4		0.26	0.19-0.3	
		80	-	0.25(1)	0.96		0.13	0.13-0.2	
	MCR	50	2.4(6)	1(6)	1	Continuous	1	1	1
		65	2.4(6)	1(6)	1		1	1	
		80	1.6(6)	1(6)	1		1	1	
Reactor starting	MCS	50	3	-	3	Short time	0.45	0.38-0.6	0.8
		65	3.9	-	3.9		0.58	0.5-0.8	
		80	4.8	-	4.8		0.72	0.6-0.9	
	MCR	50	1-1.2(6)	1(6)	1	Continuous	1	1	1
		65	1-1.2(6)	1(6)	1		1	1	
		80	1-1.2(6)	1(6)	1		1	1	

Note) Numeric value at the () of closed circuit current, isolated current means maximum value under abnormal conditions.

Numeric values at the table 6 are based on the following assumptions:

- a. Starting torque of motor is 300%.
- b. Load for reduced voltage starting is to be 80% of maximum torque at the reduced voltage. If this becomes more than rated torque, please use rated torque.
- c. Torque is proportionate with double multiplication.
- d. Line starting current at the motor should be 6 times of the current at full load. You need to Note the breaking capacity of the closed circuit under abnormal conditions at () though numeric value at table 6 is showing multiplication to the rated current of motor. As the multiplication ratio in a normal situation is assumed to be converted after reducing current and finishing a perfect start up especially transit from start up to operation, transit current will move to the close value of abnormal value if you switch before finishing start up perfectly. Regarding the switch from start up to operation, even though KS C IEC60947-4-1 recommends to convert when it reaches over 80% of the rated speed, electric endurance will diminish greatly if you switch under the situation when rev count of motor hasn't accelerated enough and starting current is not decreasing.

For reference, Fig. 43 & 44 show characteristic examples of current torque under reduced voltage startup.

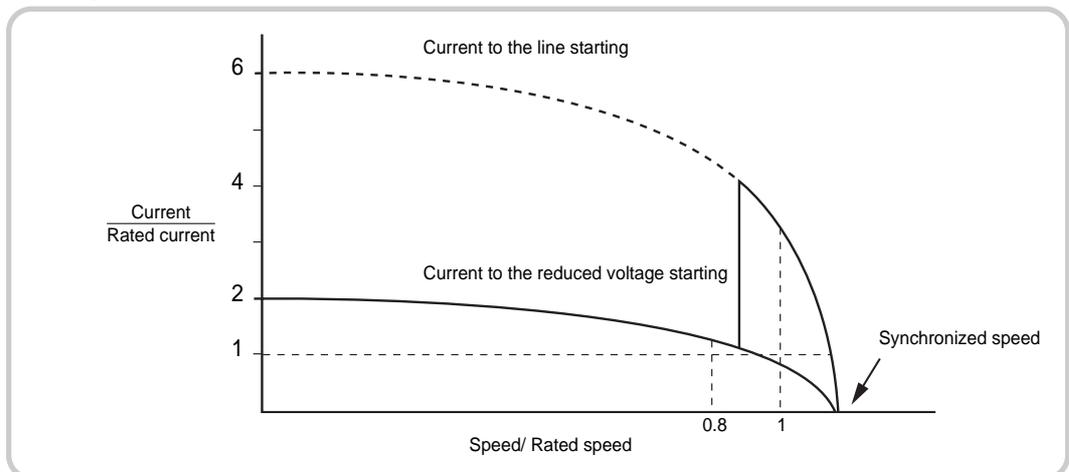

Fig. 43. Current characteristic of motor

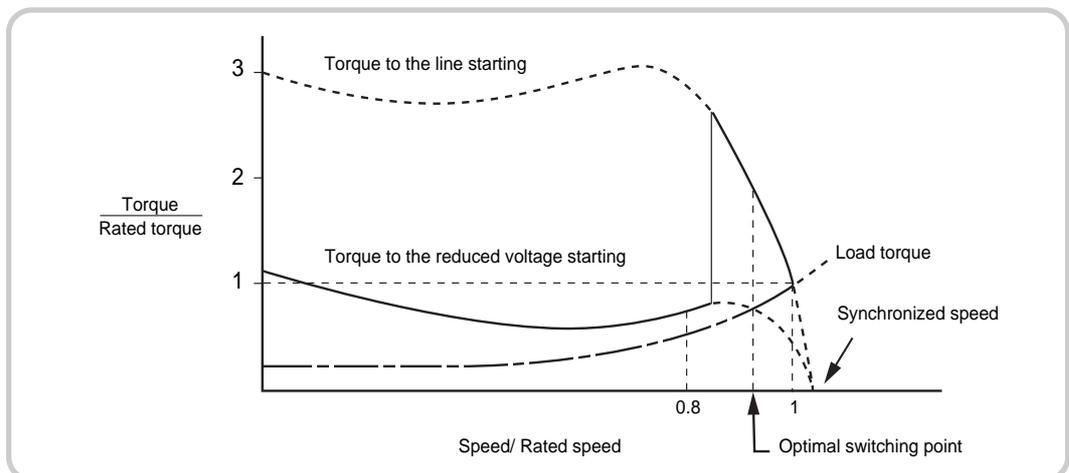

Fig. 44. Torque characteristic of motor

Starting Method and Selection

1. Starting Method and Selection

1.5 Magnetic Contactors Selection by Various Starting Methods

Table 7 shows the functions of a closed circuit as a class under the regulation of KS C IEC 60947-4-1 "switching device and control device operating under low voltage". As a general magnetic contactor is on the assumption of the squirrel cage induction motor's line starting so it has AC3 or AC4 level function. Though required level is AC3 level for the magnetic contactor of the line starting, it has a capacity of closed circuits, 10 times and breaking, 8 times as stated on the table 6. But this is considering unbalance of starting current from conditions other than voltage fluctuation and when you choose a magnetic contactor in the point of closed circuit's breaking capacity against reduced voltage starting, it needs to have same amount of extra capacity.

Table 7. Category of magnetic contactors

Category	Making capacity	Breaking capacity	Application
AC1	1.5 le	1.5 le	Resistance load
AC2	4 le	4 le	Stoppage of winding type motor
AC3	10 le	8 le	Squirrel-cage motor starting and stopping
AC4	12 le	10 le	Inching / plugging of squirrel cage motor

■ Selection based on current flow capacity and over current endurance

It is recommended to choose an magnetic contactor suitable for continuous operational based on current flow capacity as shown in table 6. But if you select the contactor which is only used during starting and has short current flow time as stated value on table 6, extra capacity is too much and non economical so you should select the contactor with lower capacity. When downsizing, please consider current flow time, current flow current, time of contactor operational, and over current endurance. Total capacity against normal operational is shown in table 6 as multiplication rate against motor output kW.

■ Electric durability of the reduced voltage starter

If you use the starter only several times per day, you only need to consider closed circuit capacity and current flow capacity, and you can ignore switching durability. It is assumed that within electric endurance during magnetic contactor's line starting, starter's electric endurance inversely proportioned to multiplication of breaking current. But you need to be careful because if it is converted during starting, the contactor's breaking current becomes the value within table 6 () and can be damaged abnormally.

■ Extra time without current flow during converting

Among magnetic contactors which are used for reduced voltage starter, there are the ones which cause short circuit fault from being closed concurrently. If electrical interlock is installed at these contactors, the possibility of simultaneous closing becomes less. But if the time is too short for operating magnetic contactor to be closed (extra time without current flow during converting) after breaking with starting magnetic contactor, there is a possibility of short circuit fault by arc. There are manipulations by relay or timer during converting not changing frame size of magnetic contactor considering abnormal situation at the high voltage circuit.

■ Voltage drop

Voltage drop can be great during starting because it is using a relatively small power capacity. Especially in case of a star-delta starter with an open transition type, when it changes from star to delta, the motor's circuit is closed before power is supplied when delta is input later, and there will be a big rush current and as this will greatly reduce power voltage, so it is recommendable to use magnetic contactor having excellent reduced voltage endurance.

2. Star Delta Starting Method

2.1 Understanding star delta (Y-Δ) starting

Star-delta starting is representing type of reduced voltage by only executing connection transfer of winding without installing special starting device. Each winding starts with 1/3 of voltage between wires exerted, when closing MCs. It drives by opening MCs, closing MCΔ. and winding with disconnection. Line current, starting torque are I_{Δ} , T_{Δ} when direct starting with disconnection, and they are I_Y , T_Y when Y disconnection, current ratio is as following

$$\frac{I_Y}{I_{\Delta}} = \frac{(V/\sqrt{3})/Z}{\sqrt{3} \cdot V/Z} = \frac{1}{3} \quad (z \text{ is equivalent impedance of motor per phase})$$

Torque is also proportional to square of voltage, so torque ratio is as following.

$$\frac{T_Y}{T_{\Delta}} = \frac{(V/\sqrt{3})^2}{V^2} = \frac{1}{3}$$

It becomes 1/3 current and torque, because torque is proportional to square of voltage. Therefore, this type is well applied to operational of light load starting.

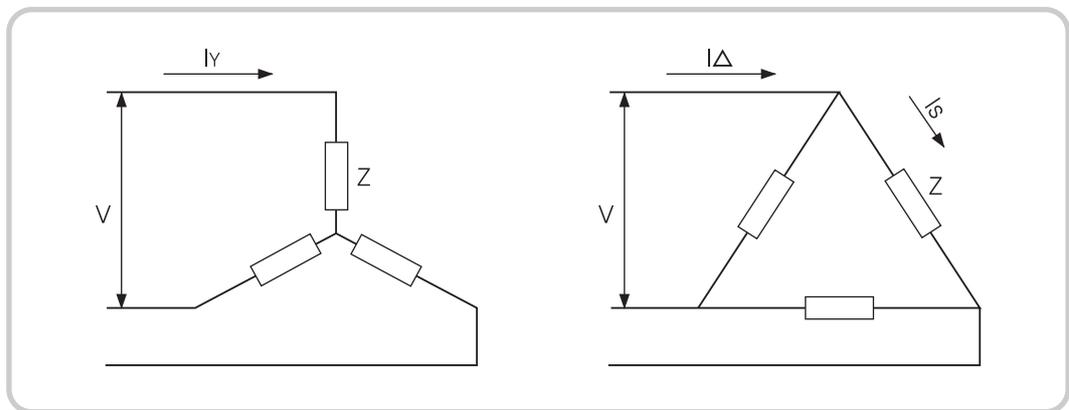

Fig. 45. Y-Δ circuit diagram

Table 8. Comparison of line starting and Y-Δ starting

Starting method	While starting(magnetic contactor for Y)				While driving (magnetic contactor for Δ)		
	Starting current	Torque	Contact current	Contact voltage	Full load current	Contact current	Contact voltage
Line starting	6Im	1.5 T	6Im	$E_m/\sqrt{3}$	Im	Im	$E_m/\sqrt{3}$
Y-Δ starting	2Im	0.5 T	2Im	$E_m/\sqrt{3}$	Im	$Im/\sqrt{3}$	E_m

Note 1) Im : full load current when Δ disconnecting electric motor

Em: line voltage

T : rated torque

Note 2) torque is estimated value.

■ Closing transfer type

A larger amount of rush current can be generated accidentally by starter winding residual voltage of motor and phase difference with power voltage when delta connection than when line starting, because open transfer type opens temporarily from power when transfer to star delta disconnection.

The value becomes 1.58 times of when line starting with assumption of the worst case, rush current becomes the worst $6 \times 1.58 \approx 9.5$ times (symmetrical AC) of full load current, to the contrary, in the case that line starting current (symmetrical AC restoration) is 6 times of full load current. Rush current becomes asymmetrical AC restoration superposed with DC restoration when actual delta connection.

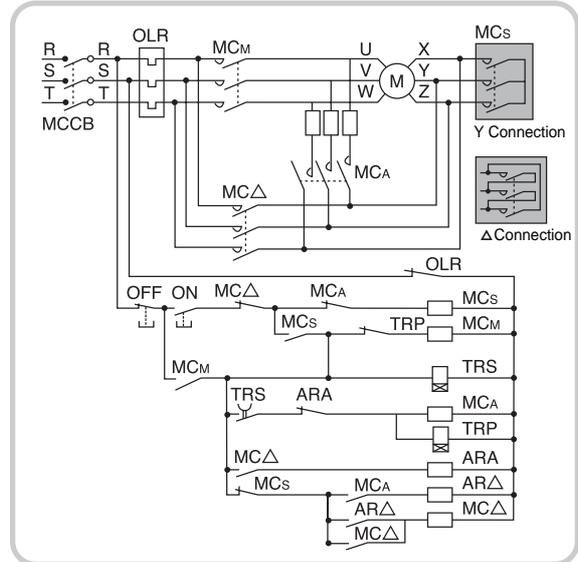

Fig. 48. Connection diagram example of star delta starter (closing transfer type)

Superposition ratio: Generally, $\alpha = 1.1 \sim 1.3$ depending on circuit power factor in case of a squirrel-cage type motor. Asymmetric current value becomes $9.5 \times \alpha = 10.5 \sim 12.4$ times of full load current in case of an electric motor with 6 times, starting current multiplying factor by this. Therefore, this can cause trouble such as a mis-trip of the distribution breaker of an electronic tripping type or transient voltage decrease to an abnormal power facility. The star delta starter of closing transfer type which is shown in Fig. 48 adds starting resistor and magnetic contactor for resistor to open circuit transfer type star delta starter and restrains transient rush current by transferring motor at power without breaking with star delta disconnection. By this type, Mis-trip of distribution breaker by rush current can be prevented, and it is possible for miniaturization and cost down of emergency generating facility by determination of generator's capacity from motor starting KVA.

■ TOR current detection method

The TOR has a different selection of heater rating by line current detecting type and phase current detecting type star delta starter shown in figure 49 and 50. line current detecting type is selecting heater rating with the standard of motor's full load current. Phase current detecting type is selecting heater rating with the standard of $1/\sqrt{3}$ current of motor's full load current. A smaller TOR frame size is more possible than line current detecting type with this type.

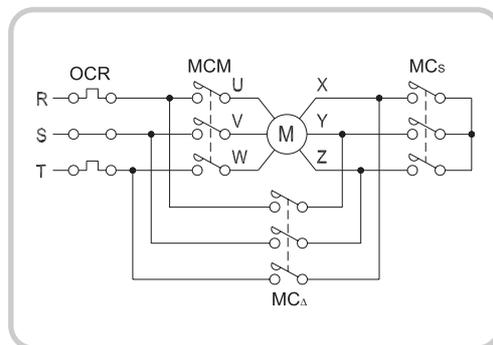

Fig. 49. Line current detecting type

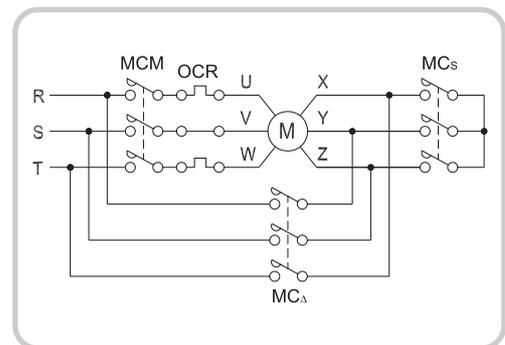

Fig. 50. Phase current detecting type

Starting Method and Selection

2. Star Delta Starting Method

2.3 Product Selection for Star Delta of Metasol MC

Operating voltage(V)	Contactor per operational	Motor power(kW)															
		5.5	7.5	11	15	18.5	22	30	37	45	55	75	90	110	132	160	
		7.5	10	15	20	25	30	40	50	60	75	100	125	150	180	220	
220~240V	For starting (MCs) A	22b	22b	32a	32a	40a	40a	50a	65a	65a	85a	100a	130a	150a	225a	225a	
	For driving (MCD) A	22b	32a	40a	50a	50a	65a	85a	100a	130a	150a	185a	225a	330a	400a	400a	
	For power (MCm) A	22b	32a	40a	50a	50a	65a	85a	100a	130a	150a	185a	225a	330a	400a	400a	
	Thermal Overload Relay	MT-32		MT-63		MT-95		MT-150		MT-225		MT-400		MT-800			
380~440V	For starting (MCs) A	22b	22b	22b	22b	22b	32a	40a	40a	40a	50a	65a	85a	100a	100a	130a	
	For driving (MCD) A	22b	22b	22b	32a	40a	40a	50a	65a	65a	85a	100a	130a	150a	185a	225a	
	For power (MCm) A	22b	22b	22b	32a	40a	40a	50a	65a	65a	85a	100a	130a	150a	185a	225a	
	Thermal Overload Relay	MT-32				MT-63		MT-95		MT-150		MT-225		MT-400			
500~550V	For starting (MCs) A	9a,b	12a,b	12a,b	18a,b	22b	22b	22b	32a	40a	50a	50a	65a	85a	100a	130a	
	For driving (MCD) A	12a,b	12a,b	22b	22b	32a	40a	50a	50a	65a	85a	85a	130a	150a	185a	185a	
	For power (MCm) A	12a,b	12a,b	22b	22b	32a	40a	50a	50a	65a	85a	85a	130a	150a	185a	185a	
	Thermal Overload Relay	MT-12, 32		MT-32		MT-63		MT-95		MT-150		MT-225		MT-400			

Note 1) Values from table can be changed according to motor's grade and manufacturing company, it is a reference value, when using category AC3 standard squirrel cage motor or category AC2 wire wound motor.

Note 2) Motor operating time has standard of less than 10sec.

Note 3) Please select with considering condenser's rush current to load applying phase advance condenser.

Note 4) Rated output or full load characteristic have the standard of KS C4202 (general low voltage 3 phase induction motor) or KSC IEC60947.

J . Motor Protection and Selection of Thermal Overload Relay

1. Motor Protection	206
2. Selection of Thermal Overload Relay	215

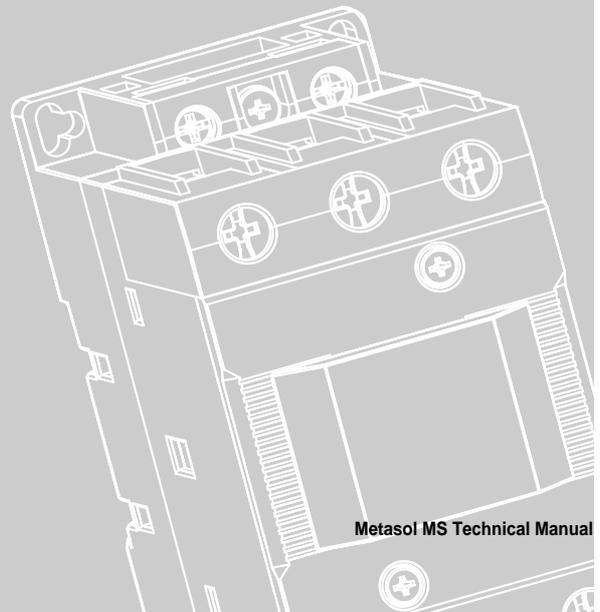

Motor Protection and Selection of Thermal Overload Relay

1. Motor Protection

1.1 Motor Protection General

The recent induction motor has been miniaturized with light-weight by improvement of insulation technology, it has a tendency of thermal margin reduction in terms of characteristic by supplying E class electric motor and using F class electric motor. Electric motor protection relay also needs to be adjusted with this thermal characteristic because of this. By the way, operational method of electric motor is widely applied to developed supply condition, variety to many different parts such as intermittent driving and variable load driving. Therefore, operational of proper protection relay is necessary for showing motor's performance and safe, proper driving of machines, facility. There are various types for protection type relay according to type operational of motor, but type of indirectly detecting motor's winding's temperature increase by line current is generally used. flush automatic temperature control device type which directly detects winding temperature is sometimes necessary, when this type is not required. Moreover, plugging by phase- reversal of disconnection driving is necessary to use jointly. Selecting proper protection relay by motor's protection condition is necessary, because sometimes reversal prevention by protection phase-reversal of disconnection driving. Table 1 shows tendency of schematic protection characteristic by parts to be protected about MT-□ □ /3K type TOR which reduce operating current when phase disconnection by adding MT type TOR, general thermal protection relay protecting overload restraint and differential amplifying device to this. It is necessary to select with preparing possible protection range and considering possibility of accident, required reliability and cost's efficiency about the detail application by written statement below.

Table 1. 3 Phase induction motor protection system and application protecting relay

Protection system		Protecting relay	MT Type Thermal overload relay		Lagged type	Open phase type
			2 Element	3 Element		
Over-load	Stand-ard duty	Generalsquirrel-cage motor	◎	◎	○	◎
		Wound-rotor type motor	○	○	○	○
		Submersible type motor	△	△	×	△
	Intermittent driving	Generalsquirrel-cage motor	△	△	○	△
		Wound-rotor type motor	△	△	△	△
		Submersible type motor	△	△	△	△
Restraint	Generalsquirrel-cage motor	◎	◎	○	◎	
	Wound-rotor type motor	△	△	△	△	
	Submersible type motor	△	△	×	△	
	Safety explosion-proof motor	△	△	△	△	
Abnormal power distribution system	Phase disconnecting driving (preventing burning)	△	△	○	○	
	3 phase unbalanced driving	×	×	×	×	
	Short circuit	△	△	△	△	
	Burning by over-short voltage	○	○	○	○	
	Leak	×	×	×	×	
	Grounding	△	△	△	△	
	Phase reversal	×	×	×	×	

Note) ◎:Completely protectable ○:Protectable except in special cases
 △:Conditionally protectable ×:Not protectable

1.2 Operating Characteristic of Thermal Overload Relay

Characteristic of MT type TOR

TOR of magnetic switch is widely used as especially protecting device of squirrel cage type induction motor. The function is separating motor with overload and restrained condition from circuit by protecting motor from burning caused by over-current. TOR is the most widely used for motor protection, because valid protection characteristic can be acquired with similar operating characteristic to current-time characteristic about allowance temperature of motor's winding at low price, and generally safety for protection has relatively fast time limit characteristic. Metasol type TOR's characteristic is as following.

1. using a contact is possible to b contact for opening magnetic contactor and different voltage circuit for indicating operation by applying 1alb.
2. Every type of heater inserted phase when 2 element is standardized to 1/L1 phase 2/T1 phase, 5/L3phase 6/T3 phase.
3. Scale indicates current value by applying RC scale(indicated by according to full load of motor).
4. It is possible to control within approximately $\pm 20\%$ range of heater title rating by controlling the front dial with plus or minus driver.
5. Manual trip is possible at front, Checking distribution is easy.
6. Heat has 2 element as a standard, but 3 element(possible for protection of phase disconnection) about every type of product can be possibly manufactured.
7. Compensating surrounding temperature
8. Manual, automatic reset transfer is possible
9. Every type has 3 pole structure, easy for distribution
- 10.TOR(Overload) for protection of phase disconnection can be manufactured(MT-□□/3K□)

Operating characteristic

Metasol series MT thermal overload relay's characteristic follows KS C, IEC standard.

Table 2. Operation at balance circuit (standard value)

Standard	Condition	Limit operation		Operation when overloaded	Operation when restrained	Surrounding temperature
		A(Cold Start)	B(A continuous)	C(Cold Start)	D(Cold Start)	
KS C IEC 60947 -4-1	Setting current multiplier	1.05	1.2	1.5	7.2	20°C
	Operating time	Not operating (2hours)	Within 2 hours	(10A) Less than 2 min.	(10A) 2<TP≤10sec	
				(10) Less than 4 min.	(10) 4<TP≤10sec	
				(20) Less than 8 min.	(20) 6<TP≤20sec	
(30) Less than 12 min.				(30) 9<TP≤30sec		

Note 1) Tp indicates operating time when restrained.

Note 2) It is a Trip Class inside the brackets.

Table 3. Operation(standard) in an unbalanced circuit(phase disconnection)

Standard	Condition	With open phase protection function		Without openphase protection function		Surrounding temperature
		3 element(MT—□3K)		3 element(MT—□3K)		
		Notoperating	Operating	Notoperating	Operating	
		A(ColdStart)	B(Acontinuous)	A(ColdStart)	B(Acontinuous)	
KS C IEC 60947 -4-1	Setting current multiplier	2pole 1.0	2pole 1.15	3pole 1.0	2pole 1.32	20°C
		1pole 0.9	1pole 0		1pole 0	
	Operating-time	Not operating (2hours)	Within 2 hours	Not operating	Within 2 hours	

Motor Protection and Selection of Thermal Overload Relay

1. Motor Protection

1.3 Protection of Motors Overload and Restrained State.

Electric motor drives within determined rating range, it has any difficulty with practical operational, because it is used in less than winding insulator's rating temperature increase. But, it is heated with larger amount of current flowing than rated current, when it is restrained or with overload. It finally causes burning by accelerating insulator's deterioration by this. Therefore, it is fundamental to break motor from circuit before winding insulator reaches dangerous temperature. The allowable time that winding insulator reaches dangerous temperature about over current in protection by detecting current, it regulates operating characteristic of protecting device. This current-time characteristic is called thermal characteristic, and winding temperature from surrounding state is defined with cold start characteristic, and it from rated temperature increase is defined with hot start characteristic. current detecting type protection device should have this characteristic.

However, TOR, the most representing current detecting type protection device regulates operating characteristic standard with standard motor, because thermal characteristic of motor is different depending on protection structure per type, pole number of insulator. Standard TOR satisfies this characteristic of standard and simultaneously considers thermal characteristic of general standard motor, therefore it is possible for standard motor's overload restrained protection which drives with load continuously.

Electric motor's state which TOR mainly protects are overload and rotor restrained state at normal circuit composition. This state can protect by matching the setting current of TOR with motor's full load current. Fig. 51. shows the relation between current-time characteristic(thermal characteristic) about winding temperature increase and MT type TOR'S operating characteristic.

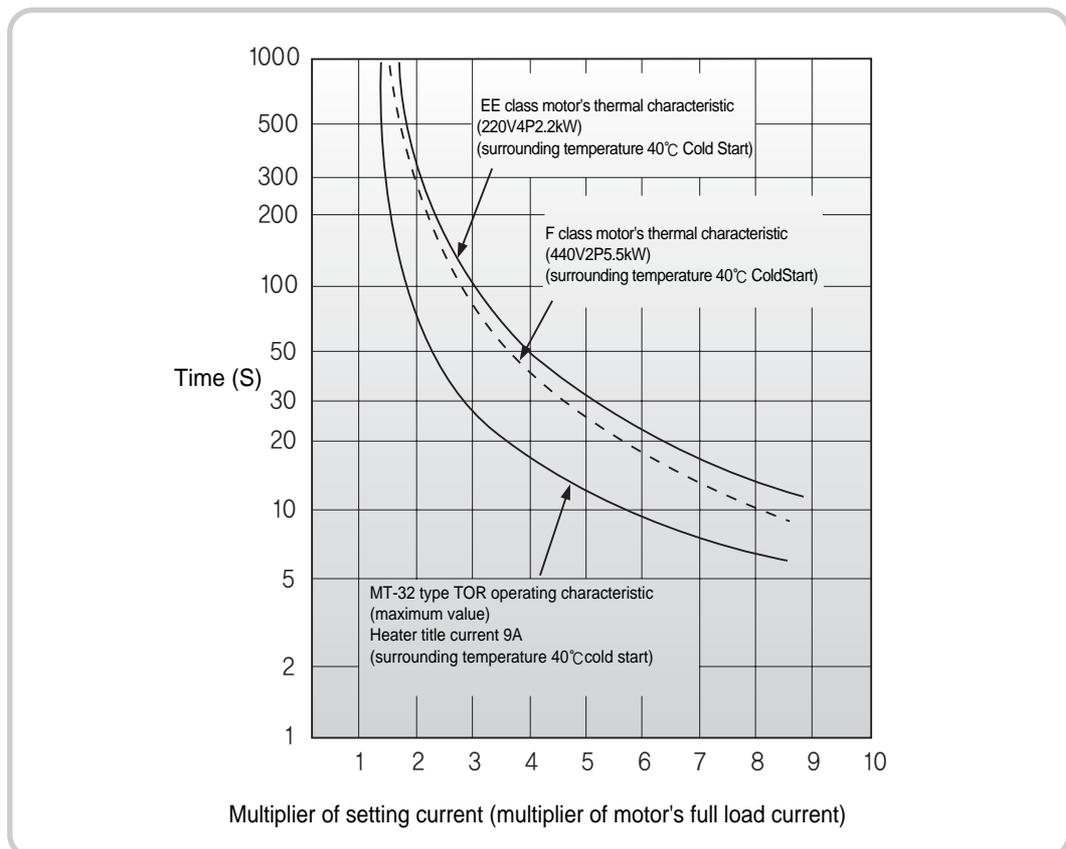

Fig. 51. Electric motor's thermal characteristic and operating characteristic of MT thermal overload relay

1.4 Three Phase Motor's Disconnection Accident Protection

Phase disconnection accidents happen when 1 phase fuses in a 3 phase circuit. Starting with phase disconnection can protect the motor from burning by operating the TOR with a single phase restraining current flow. The electric motor stops and keeps driving with a single phase restrained state and single phase, then the single phase's current value also changes by load state, the TOR operates like the following:

- Motor stop's singles phase restrained state → TOR operates
- Motor's singles phase continuous driving (more than operating current) → TOR operating
- Motor's singles phase continuous driving (less than operating current) → TOR not operating → stop → restraining restarting single phase → operating

It is mostly possible to protect for single phase overload or single phase restraint. However, preparation for any cases is required, because there are situation which cannot be prevented. Here are an example case in phase disconnection accident of 3 phase motor;

1. Direct phase disconnection of motor's input
2. Delta connection motor's internal phase disconnection
3. Primary phase disconnection of power transformer

Accident types in number 1, 2 are shown in fig. 52. assuming that the circuit opens at XYZ point. Power from the figure's values are assumed to be constant during driving, current indicates calculated current value with classification by reverse ratio.

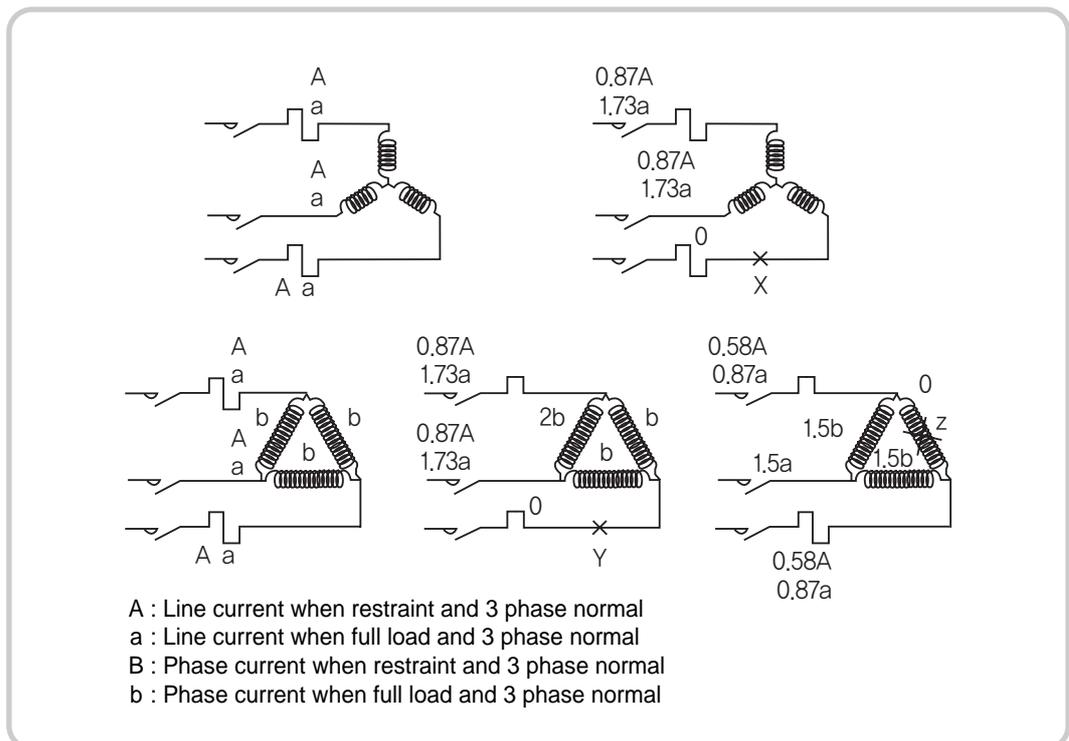

Fig. 52. Flowing current at motor's winding and protecting relay about every phase disconnection accident of 3 phase

Motor Protection and Selection of Thermal Overload Relay

1. Motor Protection

1.4 Three Phase Motor's Phase Disconnection Accident Protection

Direct phase disconnection of motor's input

The most problematic thing is the case of delta phase disconnection's motor, there flows current possible for burning deterioration by motor's winding, although phase current increase is larger than line current(detected current by TOR), it becomes $2/1.73=1.15$ times and TOR doesn't operate depending on load state shown Fig53. But, we can't say this is directly connected to motor's burning. It is because current increase of motor's 1 phase is large, but other 2 phase is small and temperature increase of maximum current flowing phase by internal thermal equilibrium of motor. However, There is copper loss and iron loss's increase caused by the skin effect influenced by a backing magnet field, as a result, it is possibly a problem for temperature increase when phase disconnection of only bulk motor. The maximum temperature increasing ratio of driving with phase disconnection about motor of every capacity and 3 phase normal winding is as figure 3. Judging with this standard, Phase disconnection protecting type (MT line K type)TOR is recommended to use about motor which has more than 3.7kw.

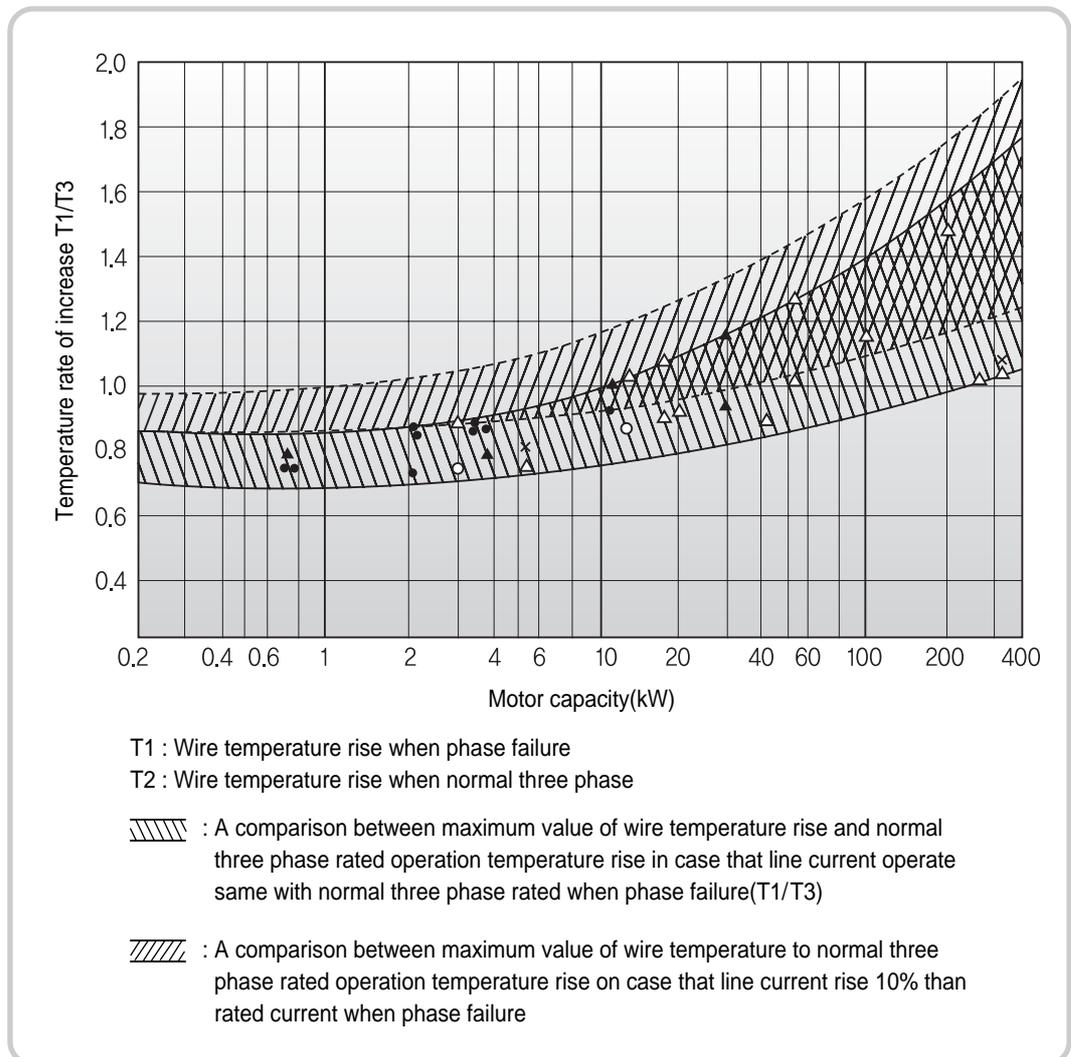

Fig. 53. Motor winding temperature increasing ratio during driving phase disconnection (cited from JEM material 139)

■ Internal phase disconnection of delta connection motor

This accident happens when one line gets disconnected or when one contact of delta side contactor generates connection fault. The likelihood of this accident is very low, and a protection relay which has very small operating current of detecting phase disconnection can be protected, such as Electro Magnetic Protection Relay(see Note 1) detecting with line current, but there is a problem in TOR and it is difficult to protect because there is a rare difference with general 3 element with insufficient phase disconnection detecting function due to every flowing current at 3 phase, when even using phase disconnection type TOR. However, it can be protected by 3 element or phase disconnection type TOR with same condition as star connection's motor protection about direct phase disconnection, if thermal relay can be put into phase of motor winding. Note 1) LSIS sells product series that magnetic electric motor protection relay is expanded to 2 types, Meta-MEC EMPR and DIGITAL EMPR. Please contact nearby sales office or visit LSIS Home page(www.lsis.biz) for more details.

■ Primary phase disconnection of power transformer

This accident sometimes happens by 1 phase fusing of primary power fuse as shown in fig 54. Motor protection has a problem with 2 element TOR in this case, but it is ok by using 3 element or phase disconnection protection type TOR. However, protecting type in a package system is sometimes realistic and economical by inserting phase disconnection relay in transformer about this accident.

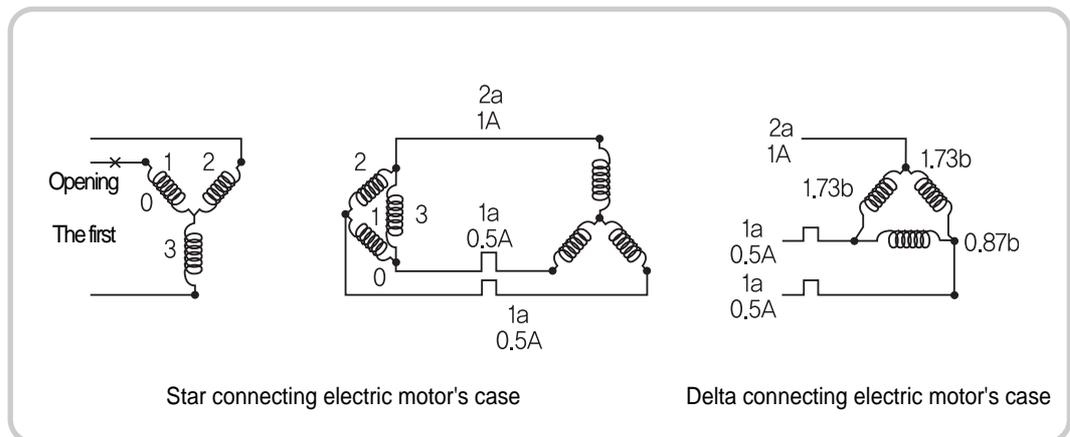

Fig. 54. Electric motor's current during transformer's primary phase disconnection

There is a similar unbalance voltage accident to phase disconnection, but it causes an increase of temperature, input and vibration due to an abnormal increase of unbalanced current by generating a big difference with normal impedance, phase reversal impedance, and simultaneously reducing output torque by generating phase torque and phase reversal torque when unbalanced voltage is applied to motor due to operational of V connection transformer or 3 phase unbalance load and large single phase load connection. The TOR should be used for preventing this accident.

Motor Protection and Selection of Thermal Overload Relay

1. Motor Protection

1.5 Protection of Electric Motor with Long-term Starting Time

Starting is impossible because the motor operates at starting time in a normal TOR, when a long time is required for starting, such as with an electric motor driving inertia's large load, and it also cannot acquire a protection characteristic. Our company solves this problem by applying a lagged type TOR, lagged type only bimetal is being used with a standard TOR.

1. Protection of electric motor with long-term starting time Prevention of unwanted operation, but starting time is necessary to be shorter than allowable restraint time and it requires caution for applying it. Protection of electric motor with occasional driving sometimes large heater is selected even with taking shortage of overload.
2. Protection of electric motor with occasional driving sometimes even a large heater is selected for making up for a shortage of overload protection, when you want to take advantage of a motor's maximum short-term output power with occasional driving (including inching and anti-phase) for motor protection. Proper selection is possible for applying with rare loss of overload protection by using lagged type bimetal especially when occasional driving is periodic.
3. Large motor protection cooperation of starting current It is easy to take protection cooperation with fuse or distribution breaker when applying to large motor of starting current, and protection cooperation of motor and short circuit including circuit accident can be acquired. (refer to fig. 55)

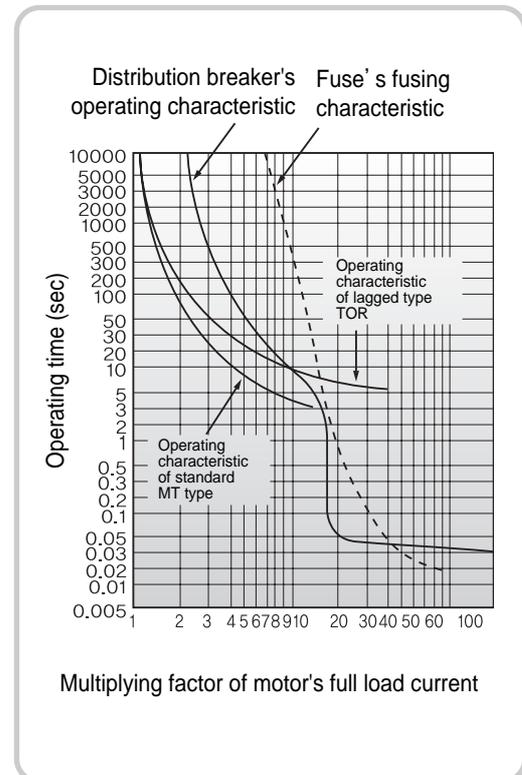

Fig. 55. MT and distribution breaker or protection cooperation of fuse

1.6 Protection of Motor with Occasional Driving

Enough preparation is required for using TOR for motor protection with occasional driving. It is difficult to expect optimized protection about motor with occasional driving by only TOR when there is big difference between thermal time constants of motor and TOR, it is necessary to find solution about each case and apply it. It is good to select control current based on motor's continuous rating when protection is prior with limiting somewhat motor's available performance, it is necessary to control large control current with taking a little loss of overload protection when you want to take advantage of maximum short-term output power. Time constant of standard TOR in this case, but it is not necessary to select large control current with using lagged type TOR. Selection of TOR's control current requires different preparation for showing motor's performance enough when intermittence is irregular, but proper selection is possible when it's periodic as following. As a reference, fig 55 shows heater temperature increase of TOR when occasional driving.

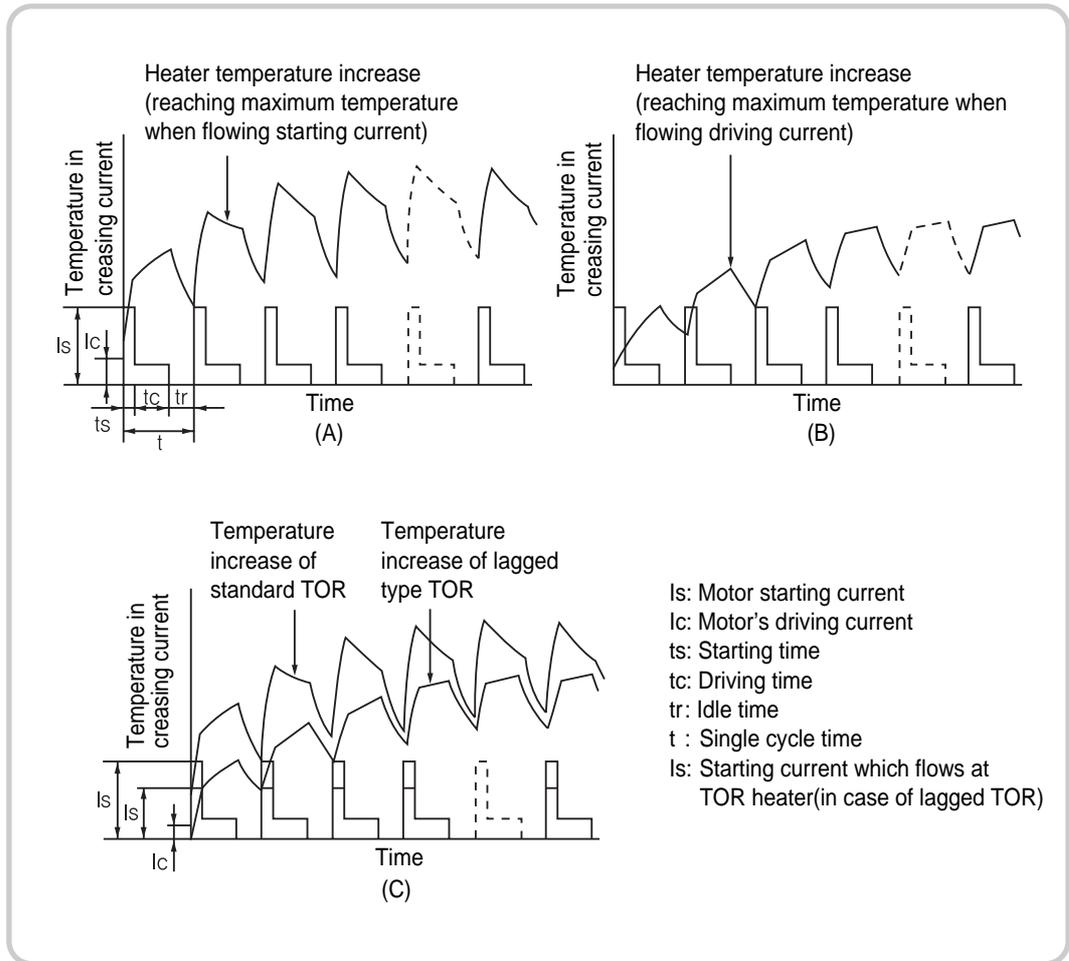

Fig. 56. Heater temperature increase of MT type TOR in the case of occasional load

- (A) : Overload protection of motor is difficult because setting current is set to be large.
- (B) : Setting current is possible for overload protection because it is selected by motor's continuous rating, but thermal time constant of TOR needs to be extremely large in this case.
- (C) : It is possible to select relatively proper setting current when intermittent driving because flowing current at heater is controlled by bimetal from lagged type TOR and it is similar to state B.

Motor Protection and Selection of Thermal Overload Relay

1. Motor Protection

1.7 Electric Motor Protection

1. Contact unwanted-operation vibration

Check if contact is separated for more than 1ms with varying uniform frequency in 10~55Hz for cycle 1 minutes by maintaining vibration acceleration $19.6\text{m/s}^2(2g)$ after setting current flowing temperature saturation to main circuit with setting value as minimum of control range. Direction of exciting vibration is 3-axis direction of top-bottom and left-right.

- Test result : All Metasol series product has no contact unwanted-operation.

2. Static vibration durability

Frequency 16.7Hz, double amplitude 4mm, direction of exciting vibration is 3 axis of top, bottom and left, right and exciting time is one hour each with each axis direction. Check characteristic variation, damage, looseness of screw bolt after exciting vibration.

- Test result: within variation ratio $\pm 5\%$ of 200% current operating time (within range of repetition error) no damage of parts, looseness of screw bolt (tightened with 80% of standard torque)

3. Contact unwanted-operating shock

Check contact separation more than 1ms with applying shock of acceleration $49.0\text{m/s}^2(5g)$ by shock wave of schematic diagram 7 after setting current flowing temperature saturation to main circuit with setting value as minimum of control range. Direction of exciting shock is 6-axis direction of top-bottom, left-right and back-forth, and number of it is 3 times about each direction.

- Test result : Every Metasol series product has no contact point' s faulty operation.

4. Durability shock

Check characteristic variation, damage before and after applying shock of acceleration $490\text{m/s}^2(50g)$ by shock wave in Fig. 57.

- Test result : within variation ratio $\pm 5\%$ of 200% current operating time (within range of repetition error) no damage of parts

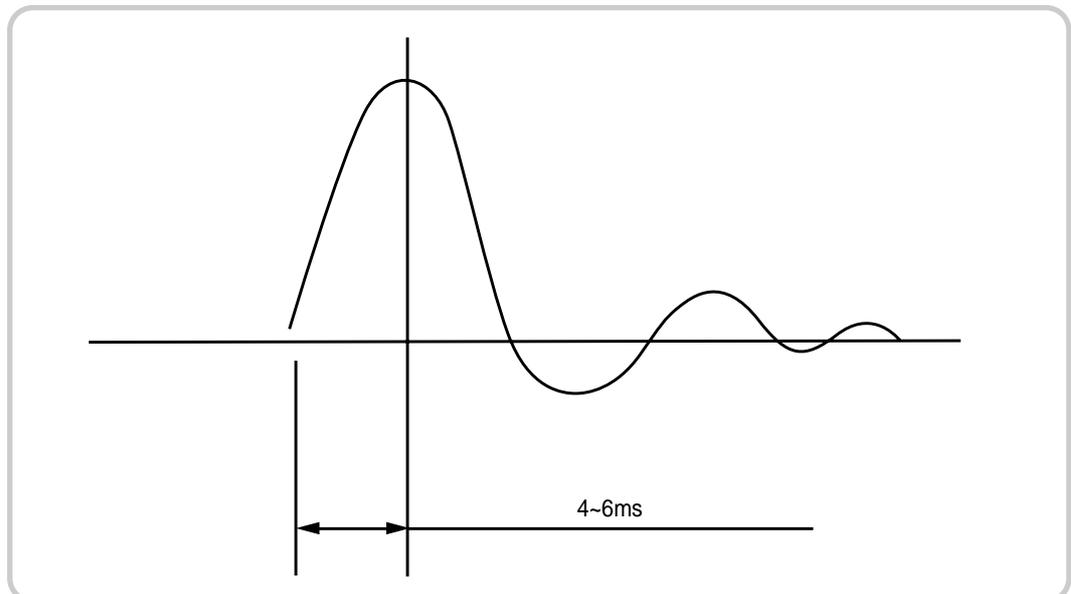

Fig. 57. Shock wave

2. Selection of Thermal Overload Relay

2.1 General of Thermal Overload Relay

Electric motor is the most common power user in almost every type of industrial facility, and they are becoming miniature, light-weight, and higher performance. Moreover, their operational purposes now include clockwise and counter-clockwise driving, and intermittent driving. This variety of driving types contributes to higher performance, and better automation of facility or machines, meanwhile causes of faults are becoming more varied not only from existing overloads and restraints, but also due to phase disconnection and phase reversal. This has also caused an increase in fault frequency. Faults of electric motors don't just include stopping, but can also involve dangerous results spreading down an entire power supplying system. Therefore, proper types of protection suitable for application conditions must be selected after checking the thermal characteristic of the motor, and verifying sufficient driving type motor protection.

■ Type of TOR (Thermal Overload Relay)

Type of TOR can be categorized by general(standard)type, phase disconnection protection type, lagged type according to using purpose per load, they are a little different depending on manufacturer.

1. General(standard) type overload relay

General(standard) type is most widely used in domestic market, it is classified with "2 element" product and "3 element product" according to number of heater detecting over-current element at each phase of internal Bi-metal. In domestic market, mainly "2 element" products are used, "3 element" product should be used for more precise load protection, because "2 element" products have no over-current detecting element structure at "S phase".

2. Overload relay of phase disconnection type

Phase disconnection protection type is a product which has "phase disconnection detecting function" is added to "general(standard) type", it is used to prevent accident by "phase disconnection", one of the biggest causes for motor's burning. "phase disconnection" means power is supplied with disconnected 1 phase among 3 phase power supplying line, internal winding of motor's deterioration (it causes motor's burning by 6~8 times of start electric current persistent flowing) happens by approximately 1.5 times of rated current flowing at other phases except for phase disconnected one, it spreads to very dangerous state with motor's burning depending on cases. Using "phase disconnection protection type" is the best which can detect other phase disconnection functions separately from general(standard) type products, because over-current increase happens rapidly during phase disconnection. Component of phase disconnection protection type product is shown in the figure on

the right. Phase disconnection protection product with ADL(Amplified Differential Lever) bulges 3 bimetal by dimension and translates in parallel to the right by Shifter-A, Shifter-B, release lever by a, but contact is not released. In case of overload stat (phase disconnection of R phase), Bi-metal releases contact for short term than overload state through bulging by b than rated load driving state in case of overload state.

Bi-metal of R phase doesn't bulge and Bi-metal of S, T phase bulges, then release lever rotates to the right by Shifter-A with center of connected point with Shifter-B, by expanding translation degree to lever ratio. In other words, it is possible to protect motor with releasing faster than release time by bulging characteristic of Bi-metal.

It is the best way to select phase disconnection type among thermal overload relay used for protection of general electric motor.

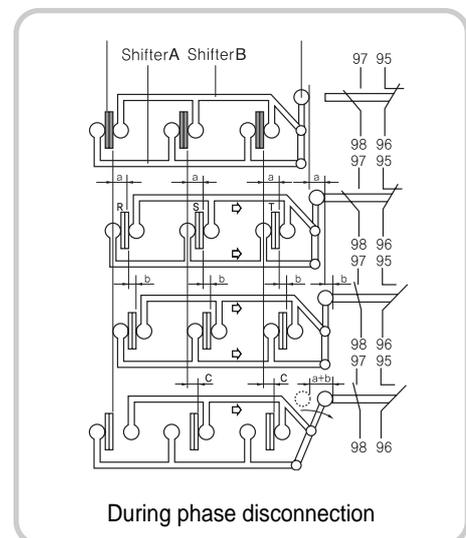

Fig. 58. ADL mechanism

Motor Protection and Selection of Thermal Overload Relay

2. Selection of Thermal Overload Relay

2.2 TOR general

3. Lagged type overload relay

The lagged type is applied to products which have large inertia such as a fan, centrifugal separator or a blower with long operating time; their operating characteristics are different from general type products. Normal driving is possible by applying lagged type product because if a trip is generated during starting, then normal driving is impossible due to a long start time with large inertia load, when general type product is applied. The following graph shows operating characteristic of general type and lagged type product, tripping time is within approximately 10 seconds when 720% of rated current is applied in case of general type product, meanwhile, it is somewhat long with approximately 20 seconds. Trip class is regulated in standard KS C IEC 60947 as following table, general (standard) phase disconnection type product is class 10A and class 20 is a standard product in lagged type, among products of LSIS.

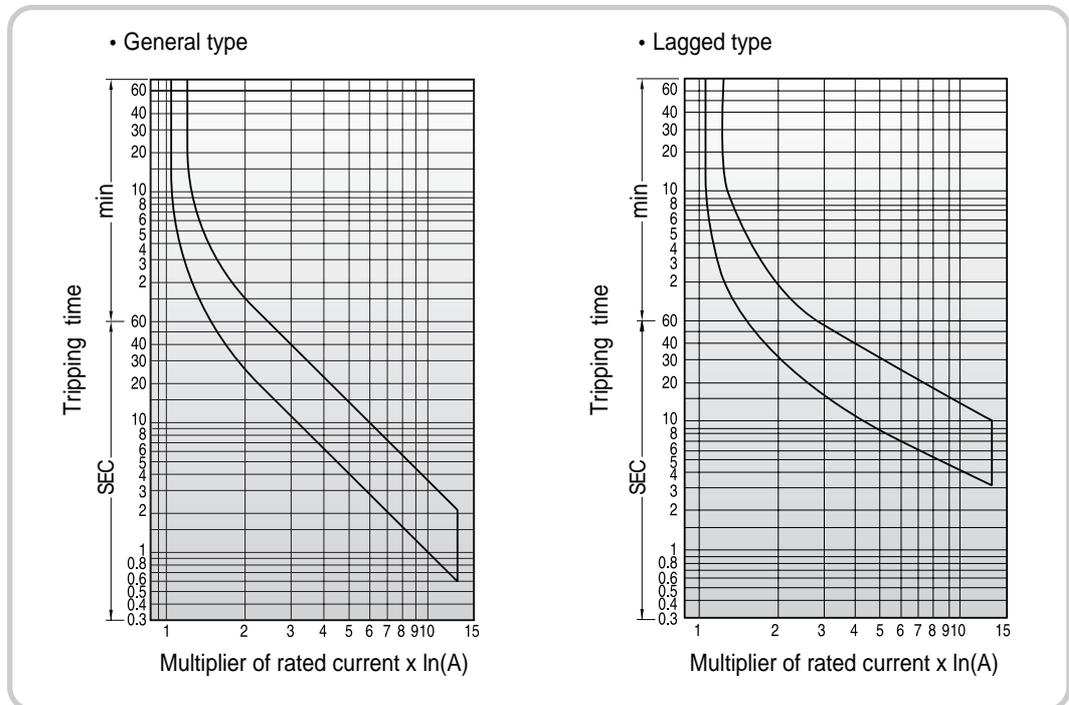
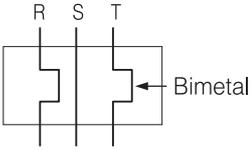
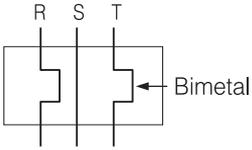
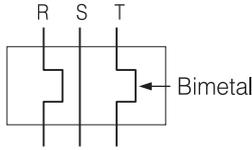
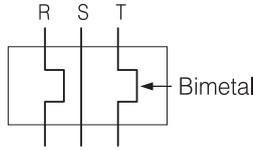
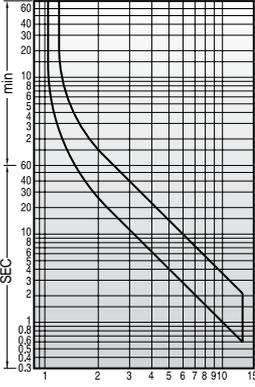
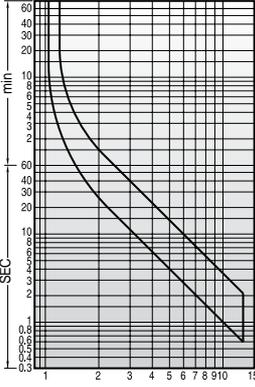
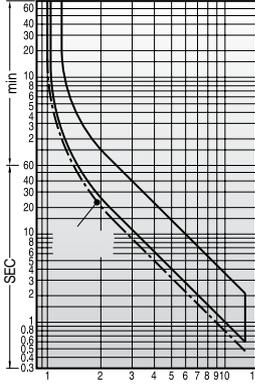
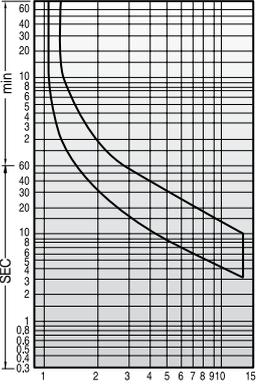

Fig. 59. Characteristic curve of general and lagged type

Table 1. Trip class standard

Trip Class	Range of trip time T_p
10A	$2 < T_p \leq 10$
10	$4 < T_p \leq 10$
20	$6 < T_p \leq 20$
30	$9 < T_p \leq 30$

Table 2. Types of thermal overload relay

Types	Thermal relay			
Exterior				
Diagram				
Name and Type	MT-□/2H 2 element type	MT-□/3H 3 element type	MT-□3K open phase protection type (3 element)	MT-□3D time lag type (3 element)
Schemez	<p>Overload detecting bimetal is used only on R and T phase. It is an economical product which is widely used in Korea and Japan.</p>	<p>Overload detecting bimetal is used all for three phases and protecting range is wider than two elements type.</p>	<p>It is a product which "differential amplification mechanism" with 3 elements type is installed to machinery unit and rapid detecting function during open phase is added. It is widely used in Europe and America.</p>	<p>Open phase detecting mechanism is added separately to three poles and three elements type and it is suitable for the load which has long starting time.</p>
Characte ristic curves	<p>Standard inverse time limit characteristic (Class 10A)</p> 	<p>Characteristic (Class 10A)</p> 	<p>Standard inverse time limit characteristic (Class 10A)</p> 	<p>Standard inverse time limit characteristic (Class 20)</p> 
Features	<p>Reset method : Basic reset type is manual.(user can change to automatic reset.) Auxiliary contact point : 1a1b Operation power : Not need Installation : It is possible to connect direct to magnetic contactor and be installed separately too.</p>			

J

Motor Protection and Selection of Thermal Overload Relay

2. Selection of Thermal Overload Relay

2.3 Understanding of Trip Characteristic Curves

Understanding of characteristic curves

The horizontal axis is a multiple of rated current and the vertical axis is the tripping time. If you look at tripping time on the graph when two times of setting current flows on the load, you can find out it is tripped at around 30 sec~1.5 min. The reason why there are two different characteristic curves is to show the error free range; the lower curve shows minimum value and the upper curve shows maximum value. So tripping time is between the minimum and the maximum value.

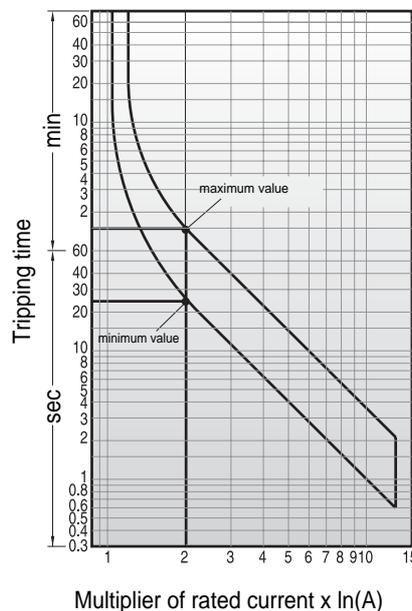

Fig. 60. Characteristic curve

The tripping characteristic of a thermal overload relay basically has an inverse time characteristic. The characteristic curve is categorized by a cold start curve and hot start curve in figure 60, the electro-magnetic motor protection relay also has same characteristic considering starting current when starting. Operating characteristic should be selected without superposition with starting characteristic curve, because normally 6~8 times of rated current is generated when starting the motor. As mentioned above, a lagged type overload relay should be used in case of load over a long operating time (blower, fan and centrifugal separator etc). The tripping characteristic of the TOR after a certain number of hours driving changes into a hot characteristic curve. Therefore, trips such as electric motor's generated overload during driving uses hot characteristic curve as standard. As is sometimes happening in the field, even though there is no trip after the first startup, if you start up again right after turning off during motor operation, there are some cases of tripping at the contactor. In this case the TOR still has the hot characteristic. This phenomenon is solved by starting after approximately 20 minutes, because the Bi-metal inside the TOR will have had time to cool off, and return to a cold start characteristic.

2.4 Tripping Characteristic Curve (MT)

The thermal overload relay(MT) can be installed and used in series with a magnetic switch or individually. There are two elements type(2H) which have a heater only on R and T phase, three elements type(3H) which have heaters on R, S and T phases, open phase type(3K) which is operated by differential amplification machinery(ADL) at open phase moment, and automatic type(3D).

Class10A, 18AF

- MT-12/2H
- MT-12/3H
- MT-12/3K

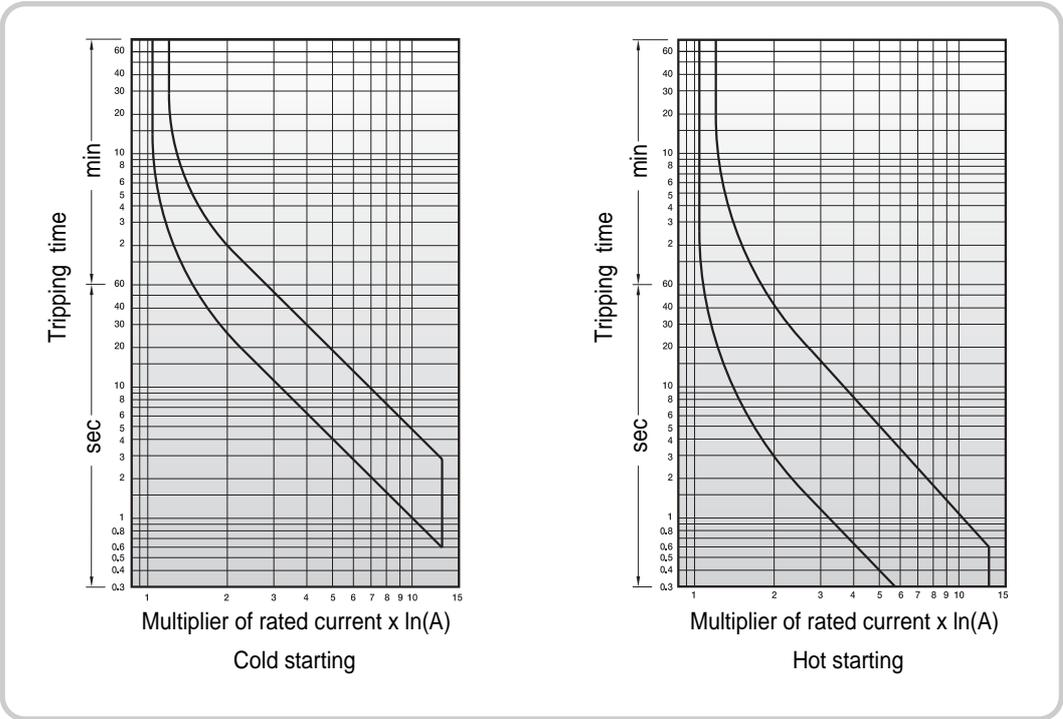

Class20, 18AF

- MT-12/3D

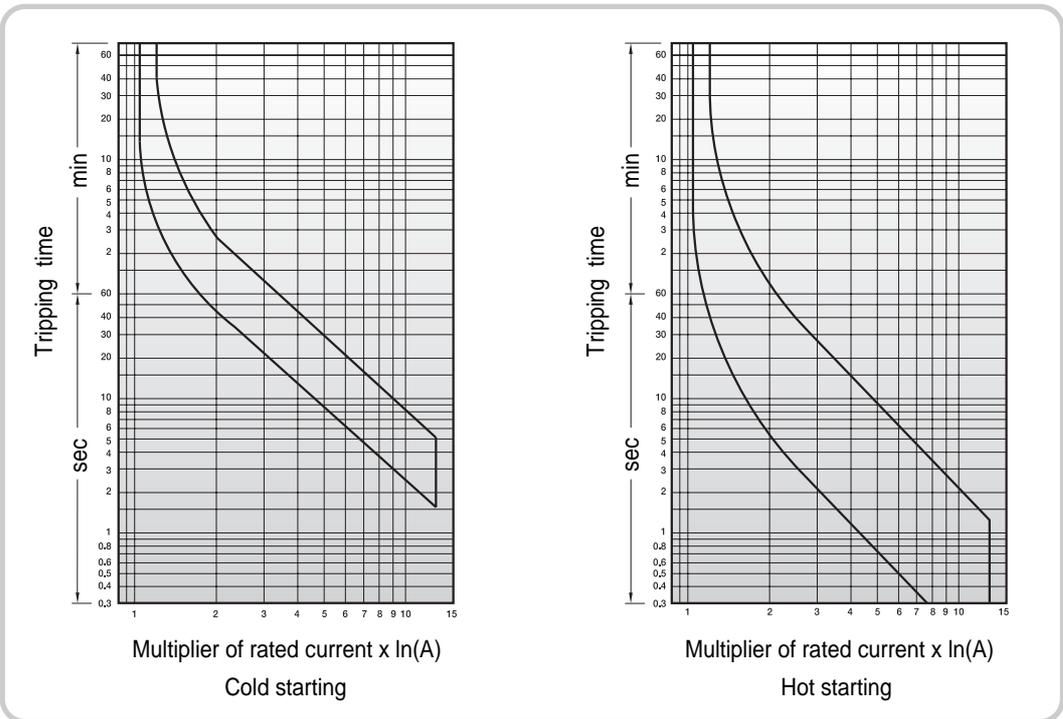

Motor Protection and Selection of Thermal Overload Relay

2. Selection of Thermal Overload Relay

2.4 Tripping Characteristic Curve (MT)

**Class10A,
40AF**

- MT-32/2H
- MT-32/3H
- MT-32/3K

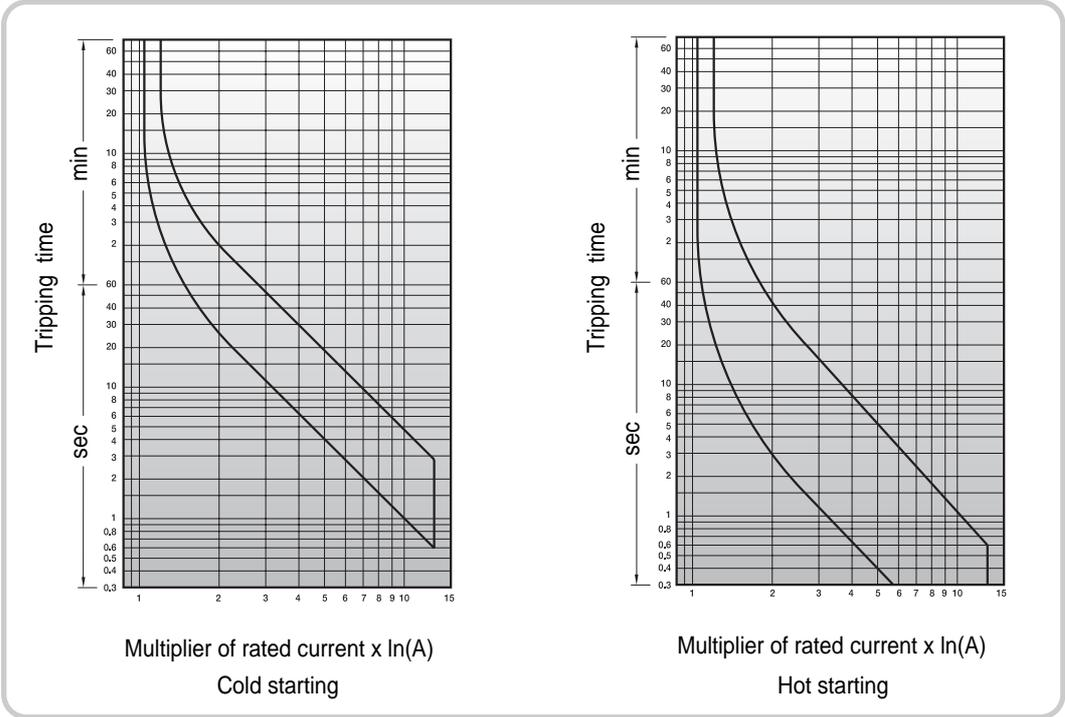

**Class20,
40AF**

- MT-32/3D

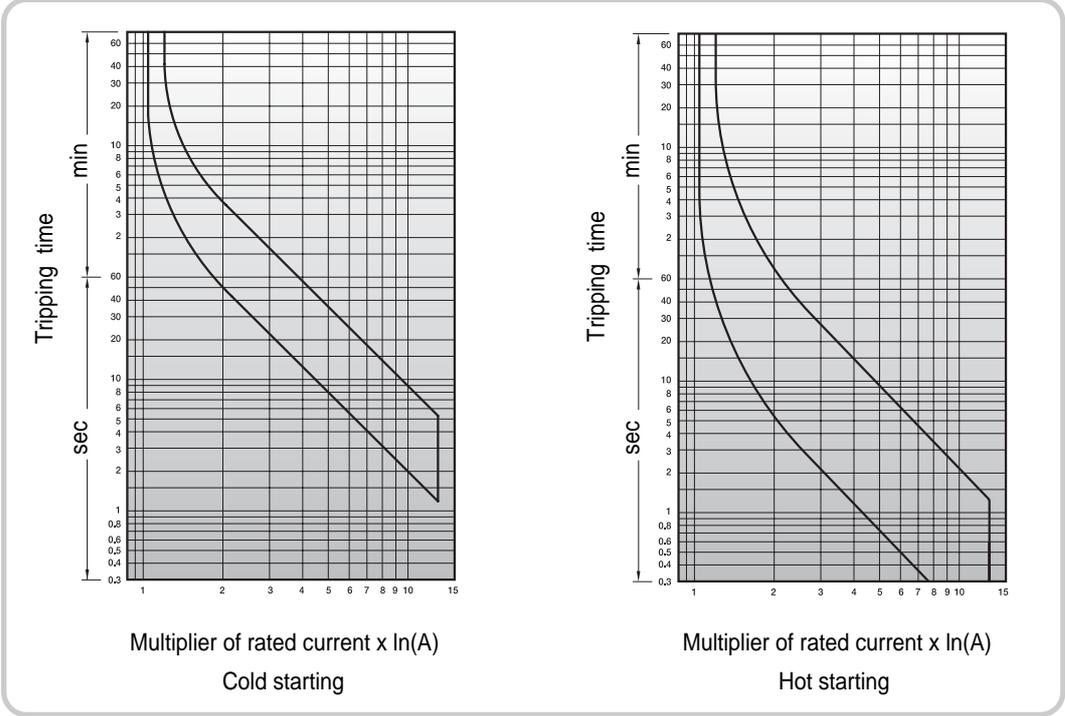

**Class10A,
65AF**

- MT-63/2H
- MT-63/3H
- MT-63/3K

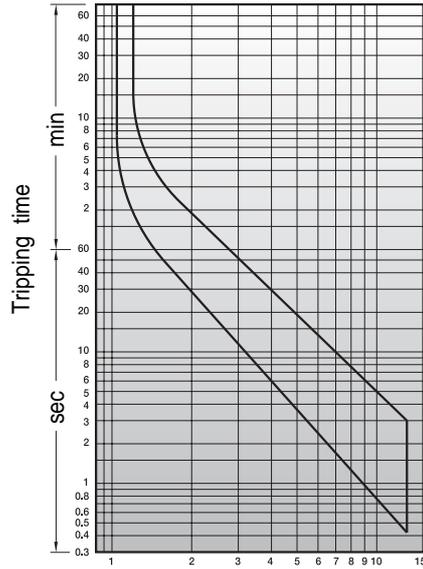

Multiplier of rated current x $I_n(A)$
Cold starting

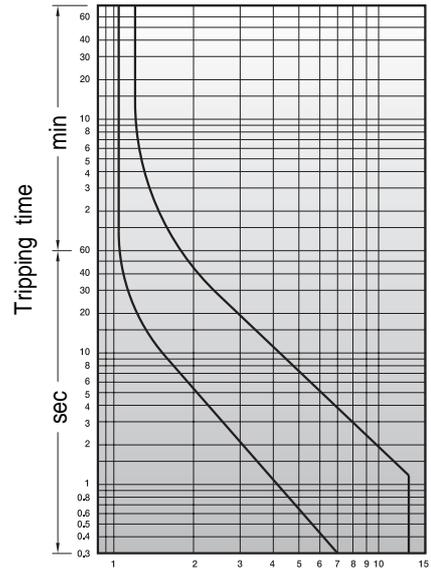

Multiplier of rated current x $I_n(A)$
Hot starting

**Class20,
65AF**

- MT-63/3D

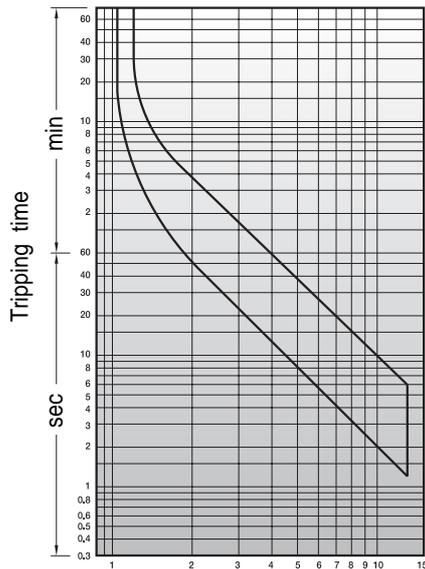

Multiplier of rated current x $I_n(A)$
Cold starting

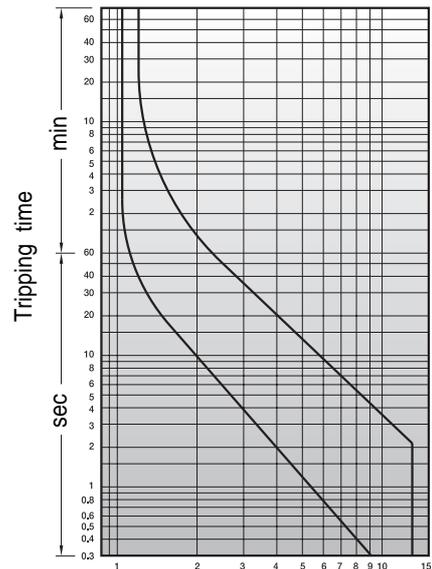

Multiplier of rated current x $I_n(A)$
Hot starting

Motor Protection and Selection of Thermal Overload Relay

2. Selection of Thermal Overload Relay

2.4 Tripping Characteristic Curve (MT)

Class 10A, 100AF

MT-95/2H

MT-95/3H

MT-95/3K

Cold starting

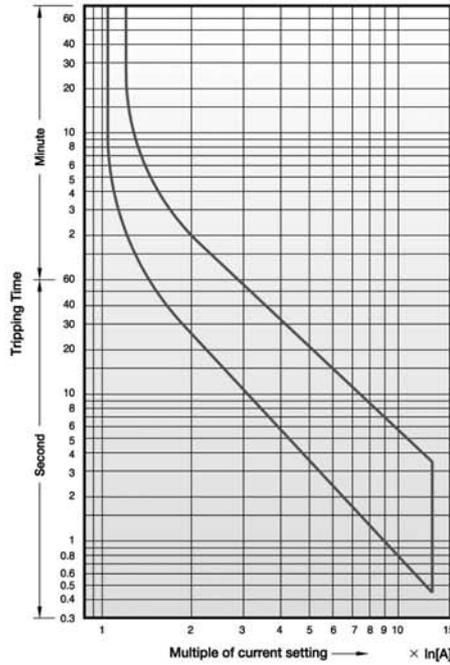

Hot starting

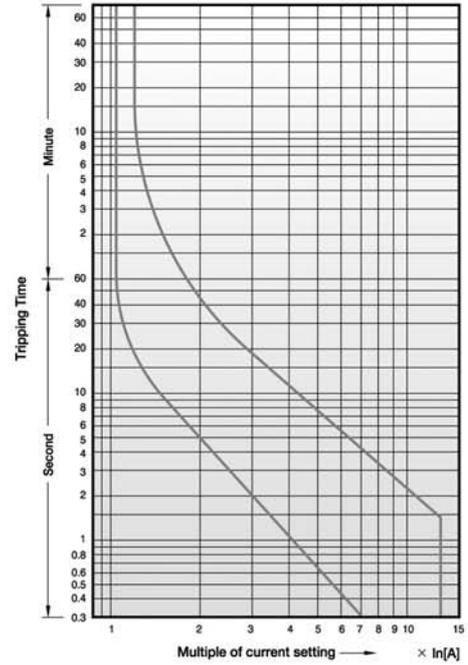

Class 20, 100AF

MT-95/3D

Cold starting

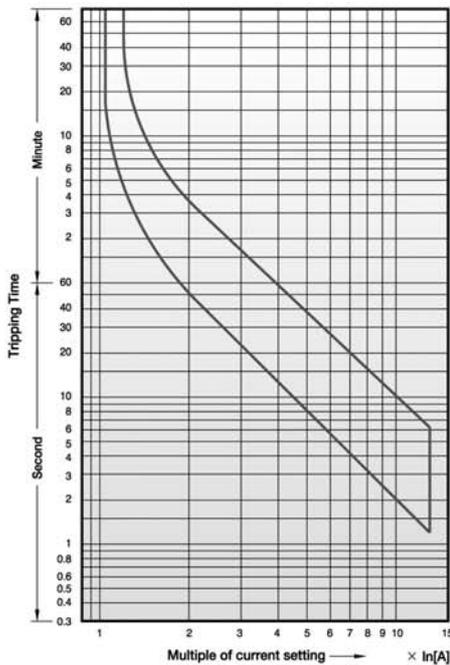

Hot starting

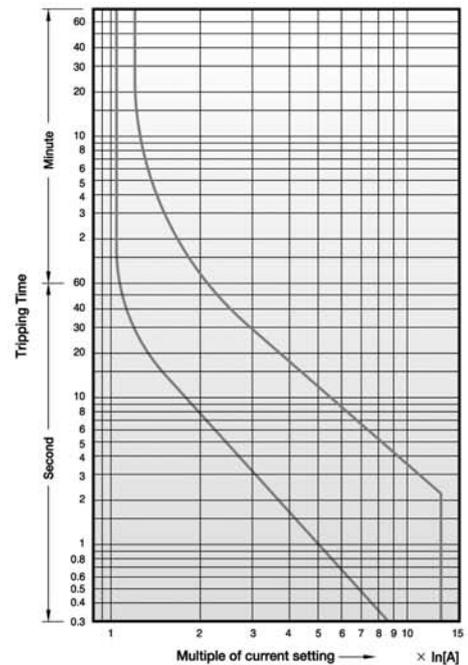

Class 10A, 150AF

- MT-150/2H
- MT-150/3H
- MT-150/3K

Cold starting

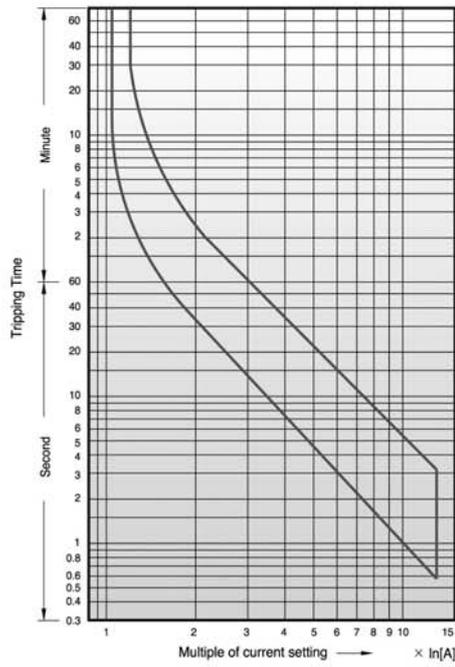

Hot starting

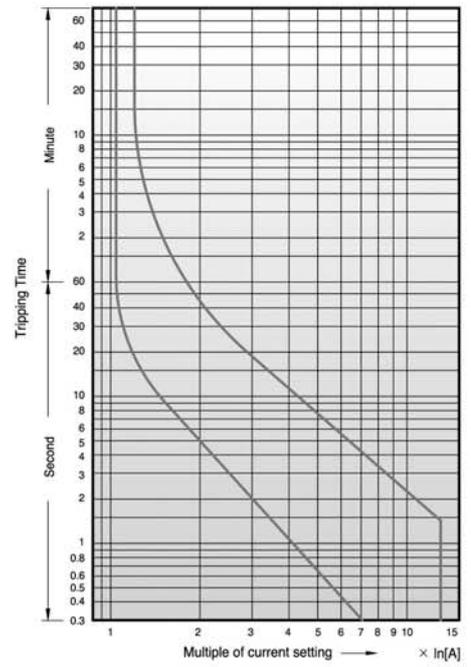

Class 20, 150AF

- MT-150/3D

Cold starting

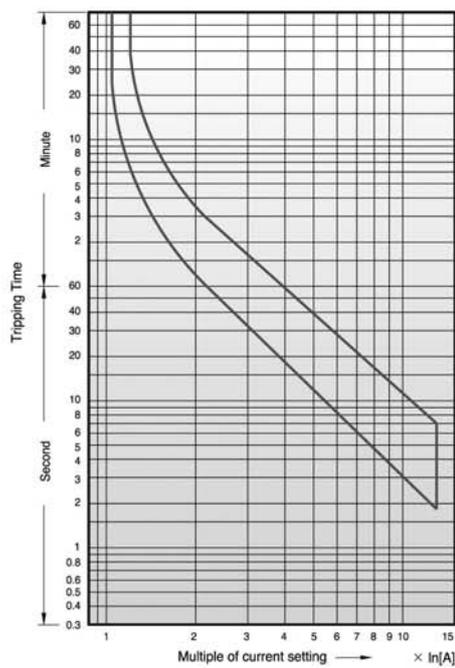

Hot starting

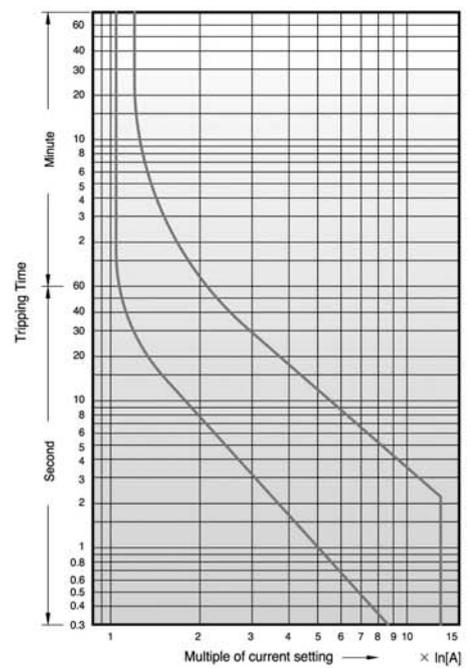

Motor Protection and Selection of Thermal Overload Relay

2. Selection of Thermal Overload Relay

2.4 Tripping Characteristic Curve (MT)

Class 10A, 225AF

- MT-225/2H
- MT-225/3H
- MT-225/3K

Cold starting

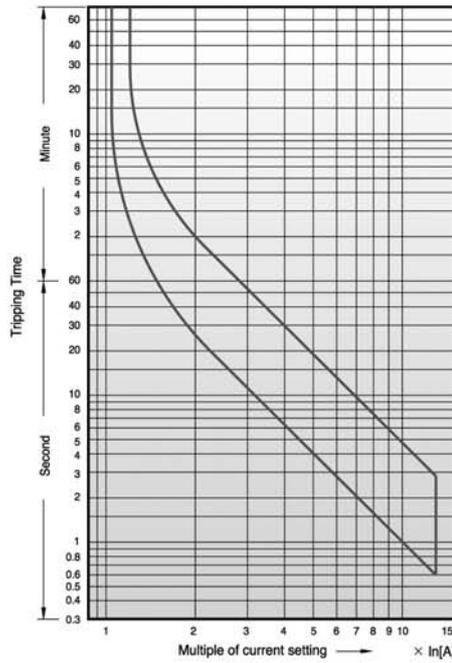

Hot starting

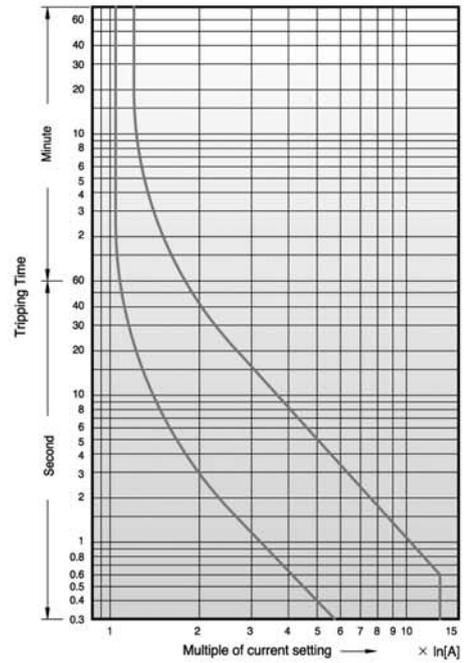

Class 20, 225AF

- MT-225/3D

Cold starting

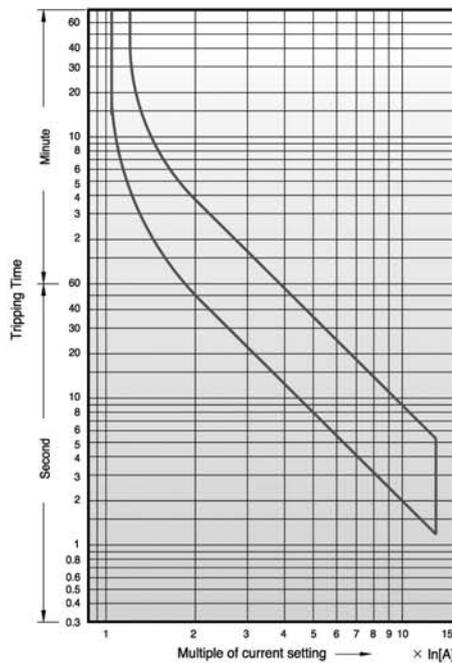

Hot starting

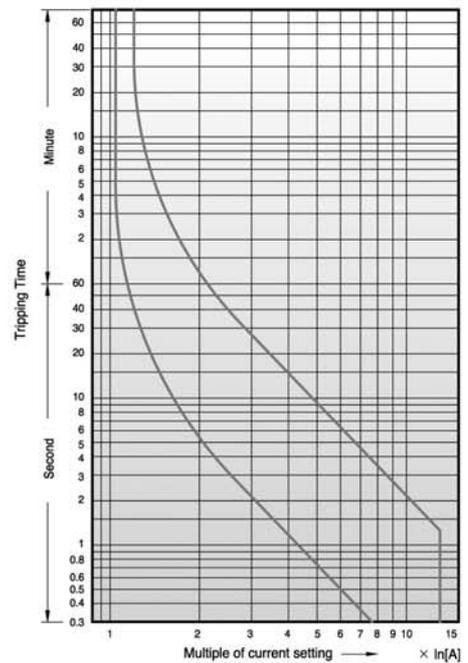

Class 10A, 400AF

- MT-400/2H
- MT-400/3H
- MT-400/3K

Cold starting

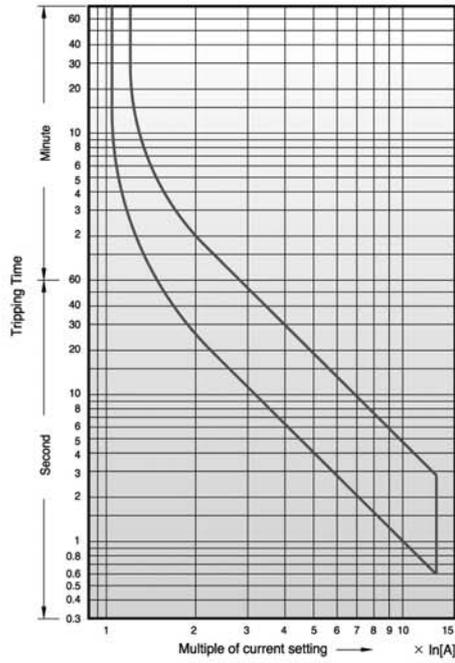

Hot starting

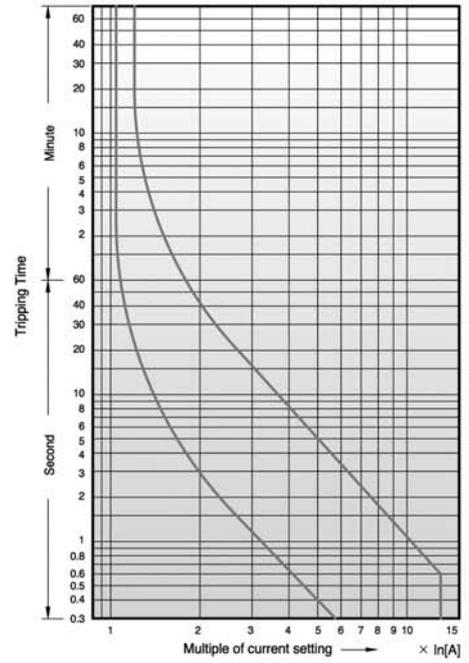

Class 20, 400AF

- MT-400/3D

Cold starting

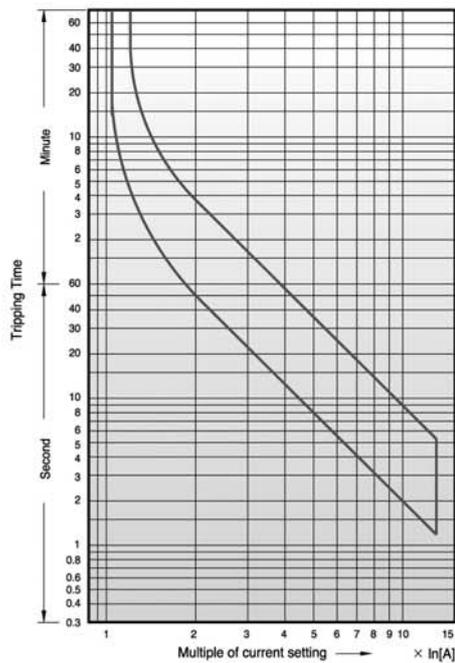

Hot starting

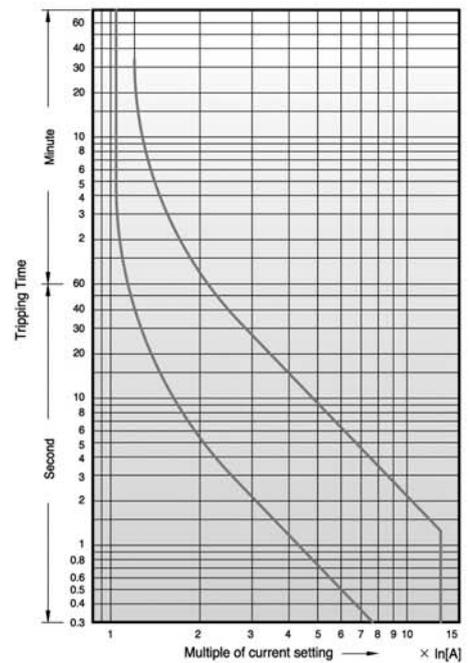

Motor Protection and Selection of Thermal Overload Relay

2. Selection of Thermal Overload Relay

2.4 Tripping Characteristic Curve (MT)

Class 10A, 800AF

- MT-800/2H
- MT-800/3H
- MT-800/3K

Cold starting

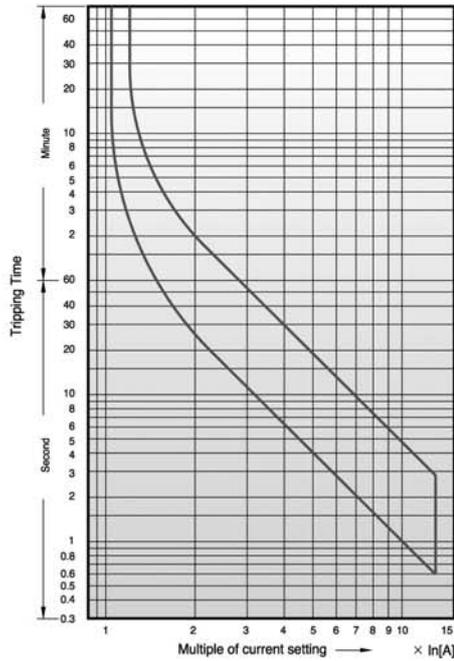

Hot starting

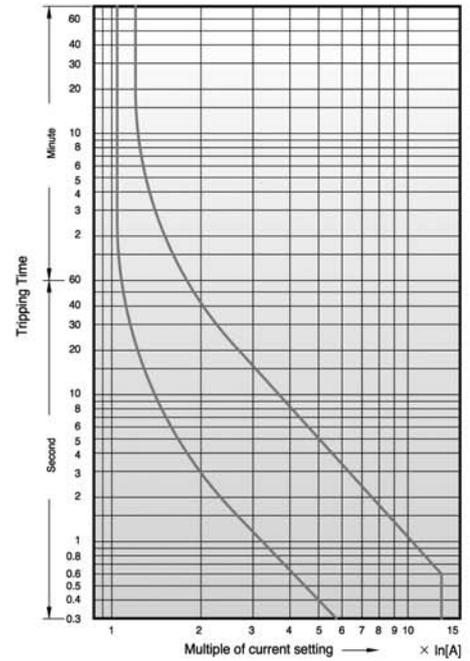

Class 20, 800AF

- MT-800/3D

Cold starting

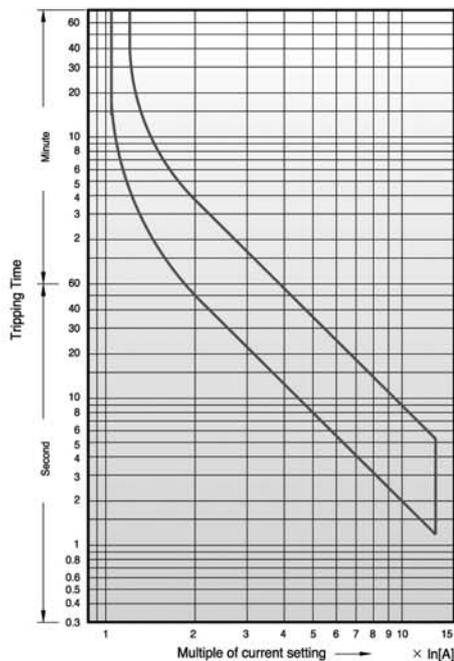

Hot starting

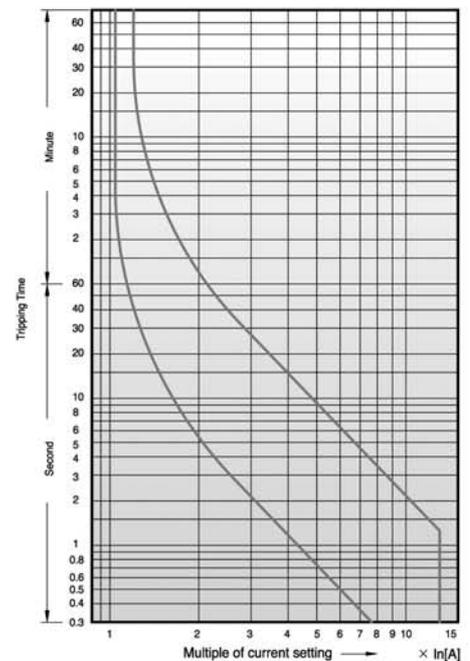

K. Coordination

1. Coordination	228
2. Machinery Selection	
Table for Type II Coordination	239

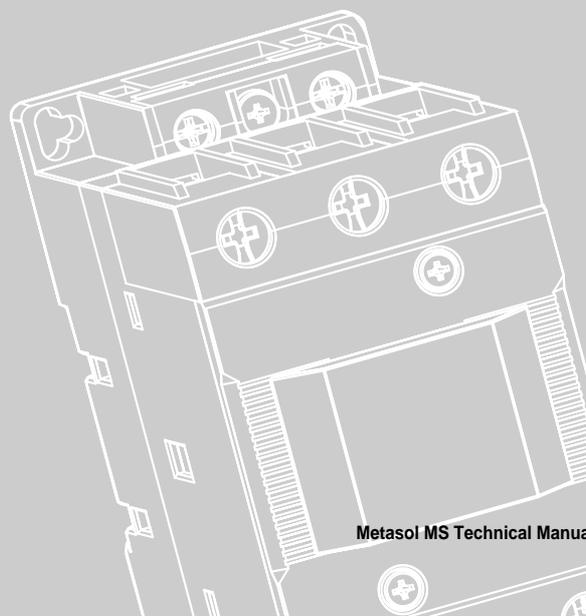

Coordination

1. Coordination

1.1 Protection Range of Magnetic Switch

Magnetic switch is mainly used for remote control of motor's starting, stopping, etc. and protecting from motor burnout by overload, binding, etc. Also its operational current range is relatively small so during short circuit, it is not capable of opening and closing large current. General magnetic switch on the market mostly has AC3 or AC4 level switching efficiency(8~10 times of rated operational current) which is designated by KSC IEC 60947-4-1 and even with extra about 10~15 times. If there is current over certain amount on TOR, except special case, there is a danger of heater fusion before it operates. To prevent heater fusion, KSC and IEC standards designate overload current flow test as resisting 13 times of current and electric installation technology and wiring regulations also test with 13 times of rated operational current. Our company's MT type satisfies above designated value(over 13 times) of the standards. So more than 13 times of rated operational current is out of magnetic switch's protection range and to protect from short circuit, you need to use short circuit protection breaker such as MCCB and ELCB, or short circuit protection fuse.

1.2 Protection Functions

1. Disconnection functions & short-circuit prot

- Breaking function Breaking motor's circuit before maintenance work
- Short circuit protection Wire and load devices protection from over current ($I > 10I_n$)

2. Control

- On and off operation Motor's starting and stopping

3. Heat and overload protection

- Overload protection Load devices protection from over current($I < 10I_n$)
- Additional characteristic protection
 1. Restrictive protection of accident (during motor operating)
 2. Preventive protection of accident (motor insulation test during motor stopping)

4. Protection range

- Overload($I < 10I_n$) Overload is occurred under following cases.
 1. Electric problem on main power(phase burnout, voltage difference between phases)
 2. Long start with excessive torque by system or motor damage (during bearing vibrating)
- Impedance short circuit($10 < I < 50I_n$) Main reason of motor insulation burnout
 - Short circuit ($I > 50I_n$)

The accident of this case barely occurs but the reason could be short circuit fault between phases during maintenance.

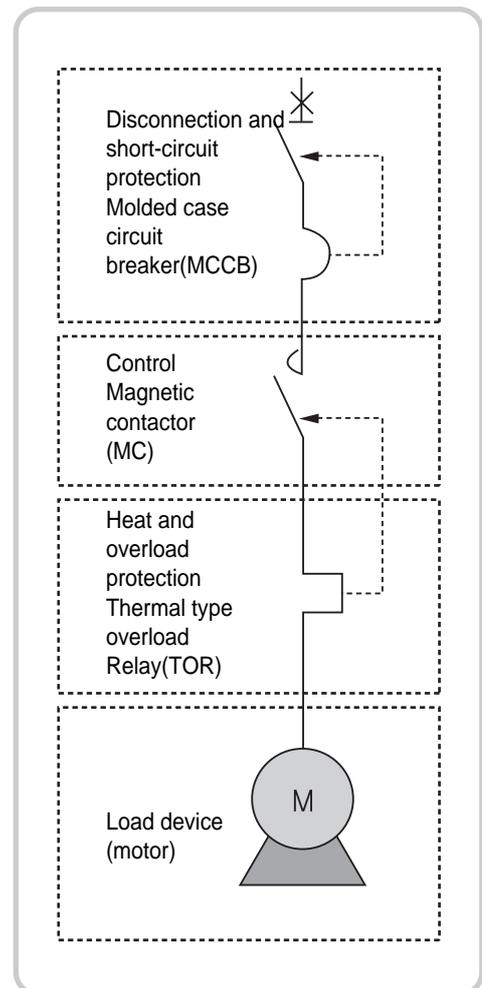

Fig. 61. Protection system

1.3 Application Standards

Motor circuit should be applied by designated general rules of KSC IEC 60947-4-1 and related contents with motor protection are as follow.

- Protection cooperation of motor circuit accessories, etc.
- Thermal type over current relay Trip Class
- Magnetic contactor application range
- Insulation cooperation

■ Different test currents

The standard for propriety of Type-2 coordination requires 3 different faulty current tests to check normal operation of magnetic switch and control devices under overload and short circuit condition.

1. "Ic" current (overload $I < 10 I_n$)

TOR provides protection against Ic value (Im or Isd function) indicated by manufacturer and this type of fault. And KSC 60947-4-1 designates two different tests which have to be operated to ensure protection cooperation between TOR and short circuit protection device.

- Apply to TOR in 0.75Ic.
- Apply to short circuit protection device in 1.25Ic.

TOR's tripping characteristic shouldn't be changed from 0.75 and 1.25Ic tests, and Type2 cooperation enhances service continuance. After getting rid of fault, magnetic contactor can be closed automatically.

2. "r" current (impedance short circuit $10 < I < 50 I_n$)

The main cause of this type of fault is insulation destruction. KSC IEC 60947-4-1 describes instant short circuit current "r". This test current is used to check if the protection device provides protection against impedance short circuit. After this test, there shouldn't be any changes on basic characteristics of the magnetic contactor or TOR. The breaker should trip within 10ms against a faulty current of over 15In.

Table1. Estimated test current value by rated operating current

Motor operational current I_e (AC3) (A)	Estimated current "r" (kA)
$I_e \leq 16$	1
$16 < I_e \leq 63$	3
$63 < I_e \leq 125$	5
$125 < I_e \leq 315$	10
$315 < I_e \leq 630$	18

Coordination

1. Coordination

1.3 Application Standards

■ Different test currents

3. "Iq" current (short circuit $I > 50I_n$)

This type of fault is relatively rare. The possible cause of this could be connection fault during maintenance. Short circuit protection is provided by rapid breaking device. KSC IEC 60947-4-1 states "Iq" current as usually over 50kA. "Iq" current is used to check protection cooperation of magnetic switch and control device which is installed to motor supply circuit. After this test under extreme conditions, all assembled magnetic switch and control device should be operated continuously.

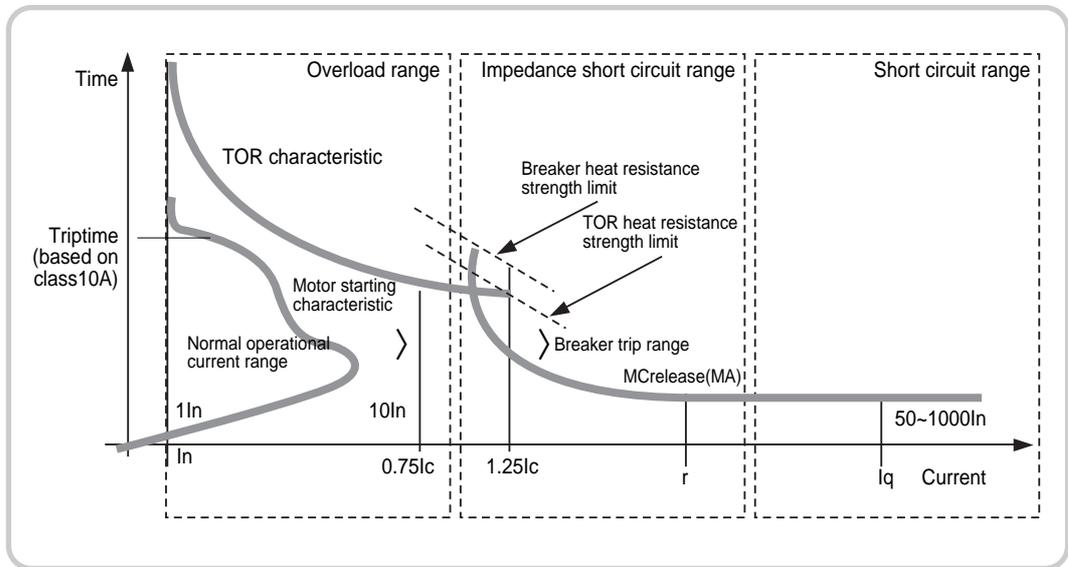

Fig. 62. Time-current characteristic curve

■ TOR Trip Class

Four trip classes of TOR are 10A, 10, 20 and 30(max. tripping time in $7.2I_r$). Generally class 10 and 10A are used the most. Class 20 and 30 are needed for motors with long starting time. You can use fig 62 and table 2 to select right TOR for motor starting time.

Table 2. Operating range by trip class

Class	1.05 I _r	1.2 I _r	1.5 I _r	7.2 I _r
10A	$t > 2h$	$t < 2h$	$t < 2 \text{ min.}$	$2 \leq t \leq 10s$
10	$t > 2h$	$t < 2h$	$t < 4 \text{ min.}$	$4 \leq t \leq 10s$
20	$t > 2h$	$t < 2h$	$t < 8 \text{ min.}$	$6 \leq t \leq 20s$
30	$t > 2h$	$t < 2h$	$t < 12 \text{ min.}$	$9 \leq t \leq 30s$

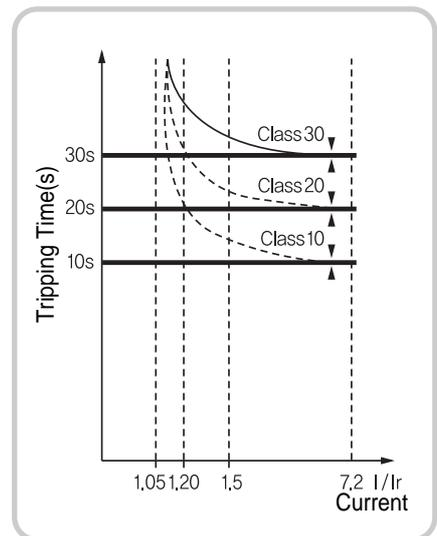

Fig. 63. Characteristic curve by trip class

1.4 General Consideration of Magnetic Switch and MCCB Coordination

■ Coordination conditions

When you determine protection cooperation for branch circuit with MCCB and magnetic switch which have motor as load, the following details should be considered.

1. Magnetic switch should certainly be able to break the maximum current which could occur under motor's normal condition.
2. TOR should definitely have an operation characteristic to protect during motor's overload and binding.
3. MCCB should have the capacity to adequately break a short circuit current which could flow on each short circuit point.(including cascade breaking)
4. The thickness of the branch circuit wire should be the size which is not to be burnt out by 12t that passes through within MCCB breaking time, if there is a short circuit current.
5. Branch circuit wire should be protected from over current by TOR or MCCB.
6. MCCB should not operate faultily from motor's starting current or rush current.(Especially, be cautious of rush current of semi-cycle during closing.)
7. Operation characteristics of TOR and MCCB have an intersecting point and extended over the full current power, the protection operating characteristic should not have a gap. Also, for current power below the intersecting point, the TOR's characteristic should be on the lower side.
8. The intersecting point of the operation characteristic should be a current value which is less than the magnetic switch's breaking capacity.
9. If there is short circuit current on the magnetic switch, it should not be damaged until the MCCB breaks.

If the above conditions are satisfied, the protection cooperation of branch circuit is able to be completed but completing economic side and all conditions are not always the most advantageous plan. The protection cooperation degree of a branch circuit can be interpreted as the reliability of a branch circuit system but regarding reliability necessity and economical efficiency, several details need to be added. So from above details, 1~6 are required but depending on economic circumstances, 7~9 can be considered by their degrees of necessity.

■ The relation between MCCB and magnetic switch operation characteristics

To protect the motor and to prevent faulty operation, a magnetic switch should be installed with an E type motor and it's TOR's operation characteristic should satisfy the following conditions.

1. Inactive operation with 105% of motor's rated current, operating with 120%.
2. Operating within 3~30sec with motor's starting(binding) current

Fig. 64 indicates the TOR's operation characteristic, the motor's heat characteristic and the motor's starting current but if each curve is same as fig. 64(A), the condition can be satisfied. This condition can be satisfied if in a modern (RC scale) TOR's selection the motor rated current is roughly the same as the heater set current.

Coordination

1. Coordination

1.4 General Consideration of Magnetic Switch and MCCB Coordination

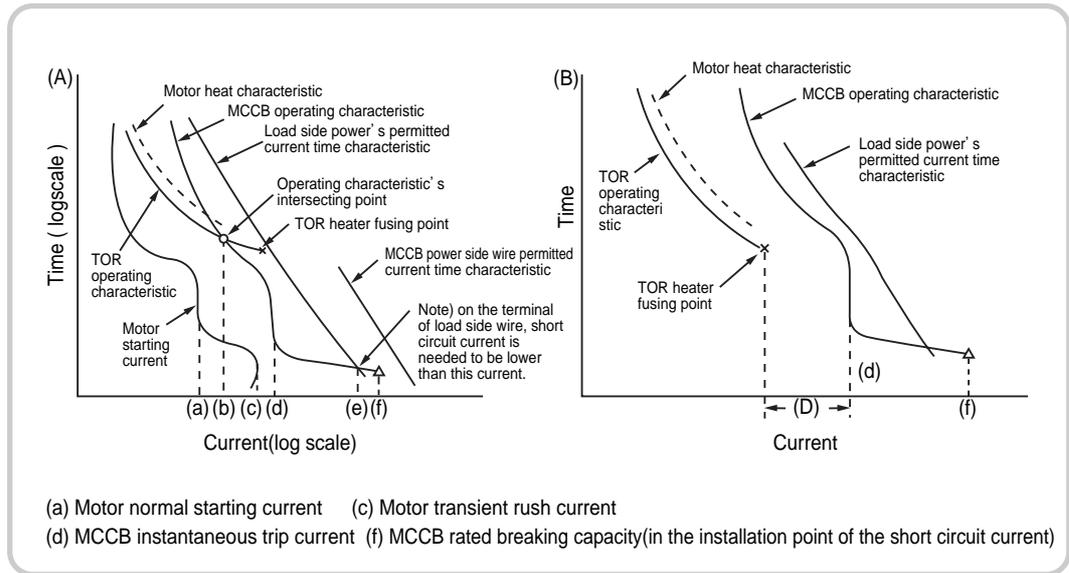

Fig. 64. Each characteristic's relation of protection cooperation

There is a possibility of faulty operation by rush current during motor's starting. For a squirrel-cage motor, approximately 5~7 times the normal starting current flows during starting but because direct current overlaps during early starting (especially very beginning of semi cycle), an even bigger transient rush current flows and the amplification changes by a power factor as in fig. 66. When motor's starting power factor is 0.4 delay, it becomes about 1.3 times of normal starting current. Moreover if there is instant restarting (after power is off, restarting before motor stops spinning), at worst it reaches two times, in other words, 2.6 times of normal starting current from effect of residual current of motor. Fig. 67 shows actual measurement results from a real motor. Instantaneous trip time of MCCB is operated around a semi cycle so it is necessary to be cautious not to be operated with selected rush current. To prevent faulty operation from this rush current, check actual measurement result and set breaker's instantaneous trip current as 14 times of rated current. After deciding operation characteristic of magnetic switch and MCCB like this, it is a problem to make each characteristic's intersecting point. Fig. 64(A) indicates when the 7th item (p231) of protection cooperation condition is satisfied and fig. 64(B) indicates when it's not satisfied. In the case of fig. 64(B), because there is gap of protection cooperation, if the current of this range flows, the TOR's heater will be fused. TOR operating characteristic MCCB operating characteristic MCCB faulty operation

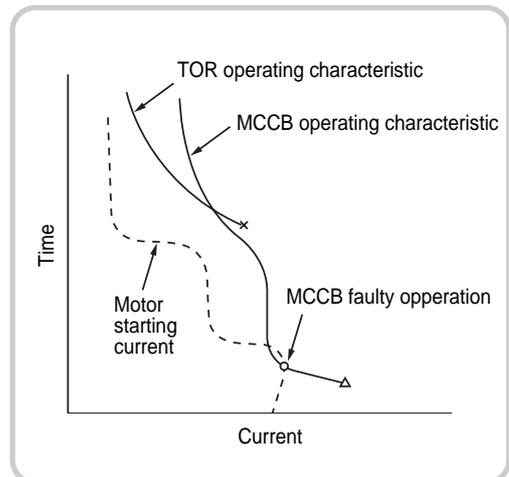

Fig. 65. Example of faulty operation by motor rush current of MCCB

Also on fig64(A), when the intersecting point of the operation characteristic exceeds the magnetic switch's breaking capacity, even if TOR is operated, the magnetic switch becomes incapable of breaking and is damaged. So in the case of having an intersecting point of operation characteristic for protection cooperation, the 8th item(p231) of protection cooperation condition needs to be satisfied. It is desirable to satisfy the condition stated in this paragraph for protection cooperation but because this kind of current range is relatively narrow and the possibility of flowing is also very rare(the current of this range is mostly from motor winding ground and layer.), it can be neglected.

■ **Magnetic switch when short circuit current flows**

If current flows on a magnetic switch, an electron repulsive power occurs between contact points. By this electron repulsive power, the magnetic switch will have contact points' loosening(separation) from 20~40 times current of usual rated operational current. So if more than that amount of short circuit current flows, an arc can occur by contact points' loosening, and there are possibilities of contact points' melting and short circuit between poles. If there is short circuit fault, it can be broken by MCCB but maximum value of the current and I^2t which flows at that point are a function of agreed short circuit current and it tends to increase together with short circuit current increase. So if over certain limit of short circuit current flows, preventing damage of magnetic switch by MCCB prevents to have arc between these contact points(do not let them rise up.) and it is difficult if it's not suppressed with extremely small amount. But when short circuit current is small with short circuit point being load side's front and end, it is possible to avoid magnetic switch's damage as stated on short circuit fault consideration (p237).

■ **Protection cooperation degree**

Now MCCB which satisfies various function and characteristics are being manufactured and also for protection cooperation, small changes can be added to magnetic switch. About the details which are considered with relation between MCCB and magnetic switch operation characteristic(p233) and magnetic switch with short circuit current flowing (p231), each step can become feasible by protection cooperation degree. Certain requirements on top of this protection cooperation degree can be decided by its necessity and economical point of view which was mentioned before. In relation to this fact, KSC and IEC standard [electric machine type contactor and motor starter] indicates following coordination types by the level of magnetic switch's damage during short circuit. Type "1" is that contactor or starter should not be the main cause of harming human or facilities under short circuit condition and it doesn't have to be suitable to use continuously without repairing or exchanging accessories. Type "2" is that contactor or starter should not be the main cause of harming human or facilities under short circuit condition and it should be used continuously. When manufacturer is instructing steps to take for device repair, it is okay for contact point to be melted and fused. And as stated example of handling method with other various standards, UL standard (American Safety Standard) No. 508 and CSA standard(Canadian Safety Standard) C22-2 No. 14 designate that when 5000A short circuit current which is combined by 3~4 times of rated operational current's rated fuse or breaker, flows on magnetic switch, magnetic switch would not have any abnormality(just, contact point's melting and fusion permitted).

Coordination

1. Coordination

1.4 General Consideration of Magnetic Switch and MCCB Coordination

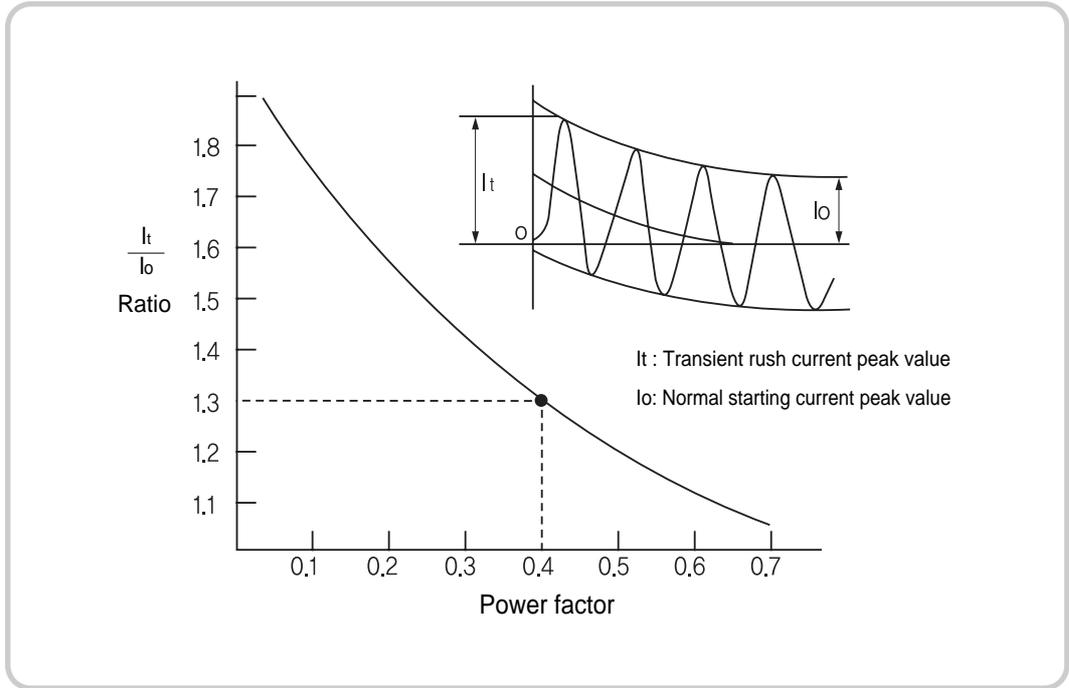

Fig. 66. Inrush current during motor's starting

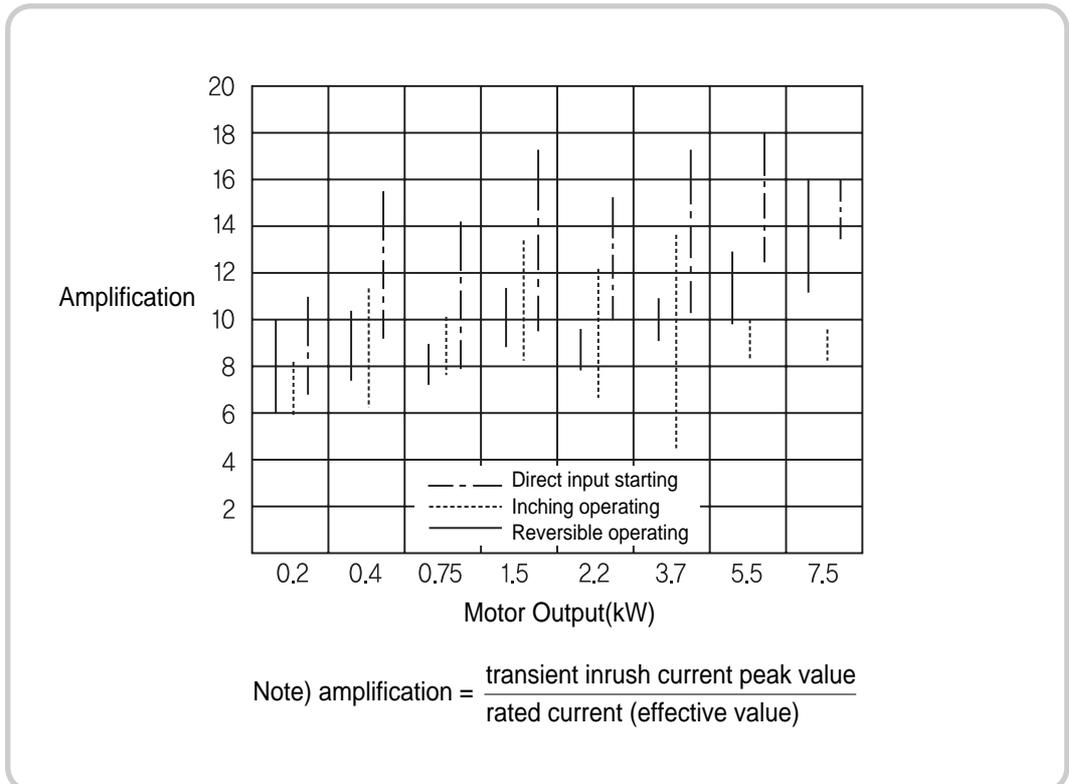

Fig. 67. Amplification of motor's rated current and transient inrush current

1.5 Coordination of Metasol Series Magnetic Switch and Metasol MCCB

■ Breaking capacity of Metasol series magnetic contactor

The intersecting point of the MCCB and the TOR's operation characteristics are not just on the breaker's inverse limit time characteristic range shown as fig. 64(A) but also on instantaneous trip range shown as fig. 68. In this case, if the magnetic contactor does not have any extra breaking capacity, it's possible for the intersecting point to exceed the magnetic contactor's breaking capacity. With consideration of this point, the Metasol series magnetic contactor has been made to have enough extra breaking capacity, and as shown on table 3, it is over 13 times of rated operational current below 440V. So even when operation characteristic's intersecting point is the same as fig. 68, maximum rated capacity can be selected for the motor so in the case of selecting protection cooperation, it is economically advantageous.

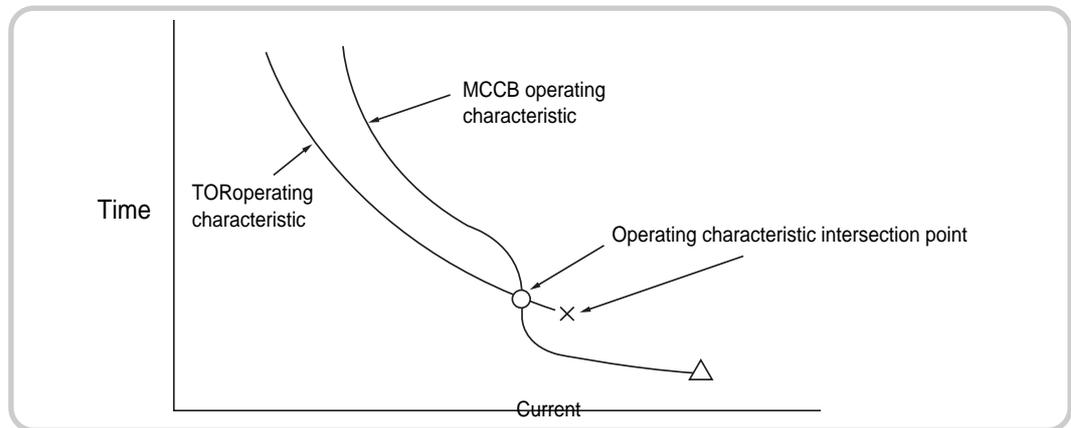

Fig. 68. Intersecting point of breaker and thermal relay

Table 3. Breaking limit of Metasol series magnetic switch

Type	Type Rated operational current(A) AC-3 level440V	Breaking possible current (kA) 440V	
18AF	MS-6a	6	100
	MS-9a	9	100
	MS-12a	12	150
	MS-18a	18	200
22AF	MS-9b	9	100
	MS-12b	12	150
	MS-18b	18	200
	MS-22b	22	208
40AF	MS-32a	32	500
	MS-40a	40	600
65AF	MS-50a	50	700
	MS-65a	65	950
100AF	MS-75a	75	950
	MS-85a	85	1200
	MS-100a	95	1200
150AF	130a	110	1800
	150a	150	2300
225AF	185a	185	2700
	225a	225	3600
400AF	265a	265	4200
	330a	330	5200
	400a	400	7200
800AF	500a	500	6400
	630a	600	6400
	800a	800	8200

Coordination

1. Coordination

1.5 Coordination of Metasol Series Magnetic Switch and Metasol MCCB

■ **MT type TOR over current resistance quantity**

The MT type TOR used in the Metasol series magnetic switch is designed either to have a slightly longer operating time to possibly bring the operation characteristic's intersecting point from breaker's inverse limit time characteristic range or to have a large heater over current resistant quantity, etc. with operation characteristic cooperation with MCCB. Particularly, the fusing point at which the heater melts before TOR operates is shown on fig. 69 but because it becomes 13 times the maximum heater current, it is considered to have a certain cooperation with the MCCB. Also, the TOR heater fusing during a short circuit fault is decided by the value of passing I^2t but heater fusing I^2t value of MT type is relatively big so it is easy to get good protection cooperation. Approximate value of MT type TOR's permitted fusing I^2t and heater fusing I^2t are stated on table 4.

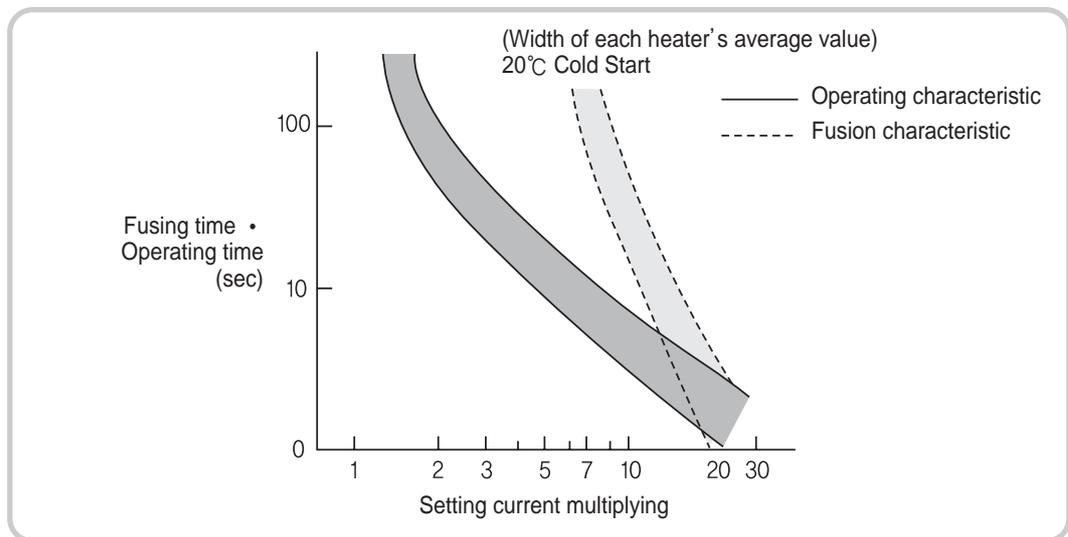

Fig. 69. Example of MT type TOR's heater fusion characteristic

Table 4. MT type TOR's permitted 12t when short circuit current passes

Type	Reusable permission I^2t (A ² s)	Heater fusion I^2t (A ² s)
MT-32	150 ~ 500 I^2	250 ~ 1000 I^2
MT-63	250 ~ 600 I^2	400 ~ 1000 I^2
MT-95	3000 ~ 700 I^2	500 ~ 1000 I^2

■ **Operation characteristic's coordination**

To prevent faulty operation, the instantaneous trip current of MCCB is set with a slightly higher value. So the rated current of a Metasol series MCCB which is to be selected for proper protection cooperation with Metasol series magnetic switch is better to be relatively small and it is almost 1.5 times of TOR heater set current. A combination example of a Metasol series MCCB and magnetic switch which are selected in regards to operation characteristic cooperation is stated on machinery selection for Type 2 protection cooperation(p239~242). The one problem regarding operation characteristic cooperation is related with short circuit capacity when it is necessary to select a breaker with a bigger frame compared to an MT type TOR's heater size. In this case, the breaker's lowest value of rated current is limited so protection cooperation can be difficult. The solution to this is applying an automatic type TOR.

■ Short circuit fault investigation

In an MCCB which has a motor with a load and branch circuit with a magnetic switch, short circuit points related with this breaker are the six spots A through F in fig. 70 and since all other points have almost no possibility of a short circuit fault, they are not considered. Therefore short circuit faults on each point are investigated as below. At first, KSC and IEC standards' protection cooperation type as protection cooperation degree (p233) was introduced but if there is short circuit fault on C or D point of fig. 70, the short circuit current is big and permitted over current of Metasol series magnetic contactor is as shown on table 5. So generally protection cooperation type will be Type"1" and it is difficult to set it as Type"2". But when the short circuit point is on E or F of fig. 70, current decrease by wiring's impedance is quite big and the calculated result (higher impedance from D point is 0.) for wire length, 50m and 100m between D and E of fig. 70 is value shown on table 6. In fact, higher impedance is also added from D point so if there is short circuit to E point, the current which flows to magnetic switch gets smaller than the value on table 5. In this case, there is big possibility of having Type "2" as the cooperation type. If there is fault on F point, current gets smaller so the condition is better than E point.

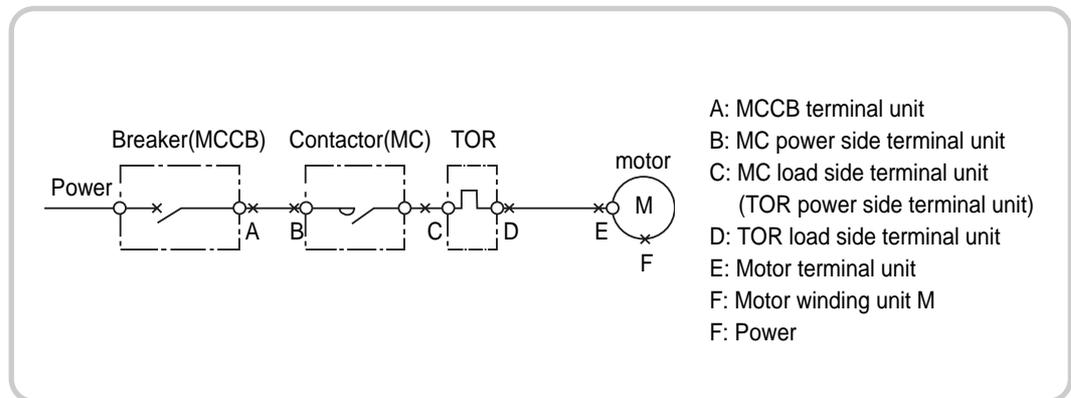

Fig. 70. Branchcircuit's short circuit points

Table 5. Metasol series Magnetic switch permitted overcurrent

Type	Current flow 10ms permitted overcurrent(A)	Wire length that short circuit current is less than permitted overcurrent from left column(m)			
		Wire size (mm ²)	Circuit voltage		
			220V	440V	550V
MS-6a, 9a, 9b, 12a, 12b	800	2	50	100	125
MS-18a, 18b, 22b	1000	3.5	16	33	41
MS-32a, 40a	1600	8	35	69	87
MS-50a, 65a	2200	14	45	86	111
MS-75a, 85a	3000	22	53	106	133
MS-100a	3000	30	69	137	172
MS-130a, 150a	3600	38	72	144	179
MS-185a, 225a	6500	60	62	124	155
MS-265a, 330a, 400a	10000	200	95	190	238
MS-500a, 630a, 800a	15000	325	114	228	285

Coordination

1. Coordination

1.5 Coordination of Metasol Series Magnetic Switch and Metasol MCCB

Short circuit fault investigation

Based on Metasol series magnetic contactor's permitted over current (the value in the case of no current limit of short circuit current with MCCB breaking time as 10ms), the calculated result of wire length which is needed to make protection cooperation Type "2" possible, is stated on table 5. This value is also calculated with higher impedance from D point as 0, so actual wire length will become a little shorter than this. Even when the length of wire is short, it is relatively easy to make possible up to certain length by methods as (1) enlarge magnetic contactor's size, (2) use MCCB with current limit effect, etc. over current resistant quantity is stated on table 4 but except small quantity rated heater, generally coordination Type "2" is relatively easily satisfied. In the case of a short circuit fault on A or B point of fig. 70, if the MCCB's breaking capacity is sufficient, there is no problem.

Table 6. Conventional short circuit current in the case of short circuit at end of wiring (symmetrical value)

Wire thickness mm ²	Short circuit current(A)			
	When wire length is 50m		When wire length is 100m	
	220V	440V	220V	440V
Ø1.6	300	600	150	300
Ø2	460	920	230	460
5.5 mm ²	800	1600	400	800
8 mm ²	1100	2200	550	1100
14 mm ²	2300	4600	1150	2300
22 mm ²	3100	6200	1550	3100
30 mm ²	4100	8200	2050	4100
38 mm ²	5200	10400	2600	5200
50 mm ²	6700	13400	3350	6700
60 mm ²	8000	16000	4000	8000
80 mm ²	10500	21000	5200	10500
100 mm ²	13000	26000	6500	13000
125 mm ²	15000	30000	7500	15000
150 mm ²	17000	34000	8500	17000
200 mm ²	19000	38000	9500	19000

Coordination of Metasol series MCCB and Metasol series magnetic switch

As investigated above, if each selection is correct, coordination of Metasol series MCCB and magnetic switch is relatively easily satisfies 1~8 details of coordination conditions (p195). But during the event of a disconnection fault, it becomes about type "2" of KSC and IEC standards coordination for short circuit on E or F point of Fig. 70 or type "1" for short circuit on C or D point. Depending on short circuit protection device, it is possible to have type "2" of coordination type even with short circuit fault of point C or D. But point C or D's short circuit occurs in magnetic contactor or TOR's terminal unit so it is impossible to avoid insulation deterioration between terminals and terminal's burnout. Eventually a magnetic switch needs to be exchanged so even with type "2" of coordination type, it should be regarded as having fewer advantages. So for coordination type during short circuit, type "2" is proper in the case of short circuit on E or F point and type "1" for short circuit on C or D point. If you interpret that 9th detail of coordination conditions (p195) is applied to the short circuit case on E or F point, as stated above, it can be said that combination of Metasol series MCCB and Metasol magnetic switch can be satisfied at certain level.

2 . Machinery Selection Table for Type II Coordination

2.1 Relation of Breaking Coordination between Contactor(Switch) and Breaker(MCCB for Protecting Motor)

When a breaker and a switch or an MMS and a switch are combined and used, the breaker breaks to protect line if there is any fault but part of short circuit current will be transmitted to lower contactor and overload relay too. So lower contactor and overload relay should be structured to resist certain amount of short circuit current.

KSC and IEC standards are regulating about this with Type II coordination item and overseas advanced companies have this type of test as a basic item, then list test contents in catalogue and technical data. According to this, LS Industrial Systems also completed the test as KSC and IEC standards at electric power test center (PT&T) and provided selecting table.

Coordination of motor circuit

Machinery selection table for Type2 coordination
MCCB+MC, MMS+MC(220/240Vstandard)

MCCB	N	H	L
TD100	85kA	100kA	200kA
MMS	S		HI, H
MMS-32	50kA		100kA

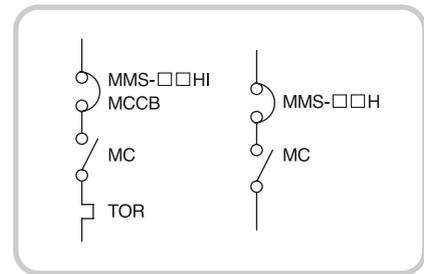

Motor rated power				MCCB, MMS		Con tactor	Thermal Overload Relay		Short circuit breaking capacity	
kW	Rated current (A)			Type	Rating (A)	Type	Type	Setting current (A)	Ir (kA)	Iq (kA)
	380V	400V	415V							
0.06	0.21	0.20	0.19	MMS-32HI	0.25	MC-6a	MT-12	0.16~0.25	1	50
0.09	0.32	0.30	0.29	MMS-32HI	0.4	MC-6a	MT-12	0.25~0.4	1	50
0.12	0.46	0.44	0.42	MMS-32HI	0.63	MC-6a	MT-12	0.4~0.63	1	50
0.18	0.63	0.60	0.58	MMS-32HI	0.63	MC-6a	MT-12	0.4~0.63	1	50
0.25	0.89	0.85	0.82	MMS-32HI	1	MC-6a	MT-12	0.63~1	1	50
0.37	1.16	1.10	1.06	MMS-32HI	1.6	MC-12a,12b	MT-12	1~1.6	1	50
0.55	1.6	1.5	1.4	MMS-32HI	1.6	MC-12a,12b	MT-12	1~1.6	1	50
0.75	2.0	1.9	1.8	MMS-32HI	2.5	MC-12a,12b	MT-12	1.6~2.5	1	50
1.1	2.8	2.7	2.6	MMS-32HI	4	MC-22b	MT-32	2.5~4	1	50
1.5	3.8	3.6	3.5	MMS-32HI	4	MC-22b	MT-32	2.5~4	1	50
2.2	5.2	4.9	4.7	MMS-32HI	6	MC-22b	MT-32	4~6	1	50
3.0	6.8	6.5	6.3	MMS-32HI	8	MC-40a	MT-32	5~8	1	50
4.0	8.9	8.5	8.2	MMS-32HI	10	MC-40a	MT-32	6~9	1	50
5.5	12.1	11.5	11.1	MMS-32HI	13	MC-40a	MT-32	9~13	3	50
7.5	16.3	15.5	14.9	MMS-32HI	17	MC-40a	MT-32	12~18	3	50
11.0	23.2	22.0	21.2	TD100	25	MC-50a	MT-63	18~25	3	70
15.0	31	29	28	TD100	32	MC-50a	MT-63	24~36	3	70
18.5	37	35	34	TD100	40	MC-50a	MT-63	28~40	3	70
22	43	41	40	TD100	50	MC-50a	MT-63	34~50	3	70
30	58	55	53	TD100	63	MC-65a	MT-63	45~65	3	70
37	69	66	64	TD100	80	MC-75a	MT-95	54~75	5	70
45	84	80	77	TD100	100	MC-85a	MT-95	63~85	5	70
55	-	-	93	TD100	100	MC-100a	MT-95	70~95	5	70

K

Coordination

2 . Machinery Selection Table for Type II Coordination

2.1 Relation of Breaking Coordination between Contactor(Switch) and Breaker(MCCB for Protecting Motor)

Motor circuit's coordination

Machinery selection table for Type 2 coordination
MCCB+MC, MMS+MC(380/415Vstandard)

MCCB	N	H	L
TD100	50kA	85kA	150kA

MMS	S	HI, H
MMS-32	50kA	50kA

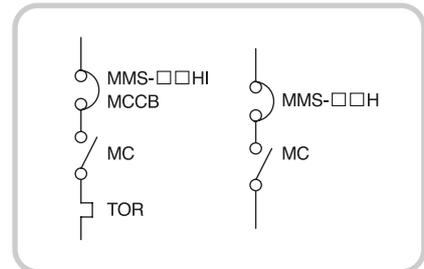

Motor rated power				MCCB, MMS		Con tactor	Thermal Overload Relay		Short circuit breaking capacity	
kW	Rated current (A)			Type ⁽¹⁾	Rating (A)	Type	Type ⁽¹⁾	Setting current (A)	Ir (kA)	Iq (kA)
	380V	400V	415V							
0.06	0.21	0.20	0.19	MMS-32HI	0.25	MC-9a(b)	MT-12	0.16~0.25	1	30
0.09	0.32	0.30	0.29	MMS-32HI	0.4	MC-9a(b)	MT-12	0.25~0.4	1	30
0.12	0.46	0.44	0.42	MMS-32HI	0.63	MC-9a(b)	MT-12	0.4~0.63	1	30
0.18	0.63	0.60	0.58	MMS-32HI	0.63	MC-9a(b)	MT-12	0.4~0.63	1	30
0.37	1.16	1.10	1.06	MMS-32HI	1.6	MC-9a(b)	MT-12	1~1.6	1	30
0.55	1.6	1.5	1.4	MMS-32HI	1.6	MC-9a(b)	MT-12	1~1.6	1	30
0.75	2.0	1.9	1.8	MMS-32HI	2.5	MC-9a(b)	MT-12	1.6~2.5	1	30
1.1	2.8	2.7	2.6	MMS-32HI	4	MC-18a(b)	MT-12	2.5~4	1	30
1.5	3.8	3.6	3.5	MMS-32HI	4	MC-18a(b)	MT-12	2.5~4	1	30
2.2	5.2	4.9	4.7	MMS-32HI	6	MC-18a(b)	MT-12	4~6	1	30
3.0	6.8	6.5	6.3	MMS-32HI	8	MC-32a	MT-32	5~8	1	50
4.0	8.9	8.5	8.2	MMS-32HI	10	MC-32a	MT-32	6~9	1	50
5.5	12.1	11.5	11.1	MMS-32HI	13	MC-32a	MT-32	9~13	3	50
7.5	16.3	15.5	14.9	MMS-32HI	17	MC-32a	MT-32	12~18	3	50
11.0	23.2	22.0	21.2	MMS-32HI	25	MC-40a	MT-32	18~25	3	50
15.0	31	29	28	MMS-32HI	32	MC-40a	MT-32	24~36	3	50
18.5	37	35	34	MMS-32HI	40	MC-40a	MT-32	28~40	3	50
22	43	41	40	TD100	50	MC-50a	MT-63	34~50	3	70
30	58	55	53	TD100	63	MC-65a	MT-63	45~65	3	70
37	69	66	64	TD100	80	MC-75a	MT-95	54~75	5	70
45	84	80	77	TD100	100	MC-85a	MT-95	63~85	5	70
55	-	-	93	TD100	100	MC-95a	MT-95	70~95	5	70

(1) If "H" model is used instead of "HI" model for MMS, use without thermal relay.

■ Motor circuit's coordination

Machinery selection table for Type 2 coordination
MCCB+MC, MMS+MC(440Vstandard)

MCCB	N	H	L
TD100	42kA	72kA	130kA
MMS	S		HI, H
MMS-32	38kA		50kA

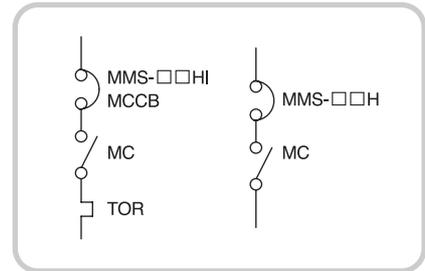

Motor rated power		MCCB, MMS		Con tactor	Thermal Overload Relay		Short circuit breaking capacity	
kW	Rated current(A)	Type ⁽¹⁾	Rating (A)	Type	Type ⁽¹⁾	Setting current (A)	Ir(kA)	Iq(kA)
	440V							
0.06	0.18	MMS-32HI	0.25	MC-9a(b)	MT-12	0.16~0.25	1	30
0.09	0.27	MMS-32HI	0.4	MC-9a	MT-12	0.25~0.4	1	30
0.12	0.40	MMS-32HI	0.63	MC-9a(b)	MT-12	0.4~0.63	1	30
0.18	0.55	MMS-32HI	0.63	MC-9a(b)	MT-12	0.4~0.63	1	30
0.37	1.00	MMS-32HI	1.6	MC-9a(b)	MT-12	1~1.6	1	30
0.55	1.4	MMS-32HI	1.6	MC-9a(b)	MT-12	1~1.6	1	30
0.75	1.7	MMS-32HI	2.5	MC-9a(b)	MT-12	1.6~2.5	1	30
1.1	2.5	MMS-32HI	4	MC-9a(b)	MT-12	2.5~4	1	30
1.5	3.3	MMS-32HI	4	MC-18a(b)	MT-12	2.5~4	1	30
2.2	4.5	MMS-32HI	6	MC-18a(b)	MT-12	4~6	1	30
3.0	5.9	MMS-32HI	8	MC-18a(b)	MT-12	5~8	1	30
4.0	7.7	MMS-32HI	10	MC-32a	MT-32	6~9	1	50
5.5	10.5	MMS-32HI	13	MC-32a	MT-32	9~13	1	50
7.5	14.1	MMS-32HI	17	MC-32a	MT-32	12~18	3	20
11.0	20.0	MMS-32HI	20	MC-40a	MT-32	18~25	3	20
15.0	26	MMS-32HI	32	MC-40a	MT-32	24~36	3	20
18.5	32	TD100	32	MC-50a	MT-63	24~36	3	50
22	37	TD100	40	MC-50a	MT-63	28~40	3	50
30	50	TD100	50	MC-65a	MT-63	45~65	3	50
37	60	TD100	63	MC-65a	MT-63	45~65	3	50
45	73	TD100	80	MC-85a	MT-95	54~75	5	50
55	88	TD100	100	MC-95a	MT-95	70~95	5	50

(1) If "H" model is used instead of "HI" model for MMS, use without thermal relay.

Coordination

2 . Machinery Selection Table for Type II Coordination

2.1 Relation of Breaking Coordination between Contactor(Switch) and Breaker(MCCB for Protecting Motor)

Motor circuit's coordination

Type2 coordination machinery selection table
MCCB+MC, MMS+MC(480/500Vstandard)

MCCB	N	H	L
TD100	30kA	50kA	65kA
MMS	S	HI, H	
MMS-32	38kA	50kA	
MMS-63	10kA	35kA	

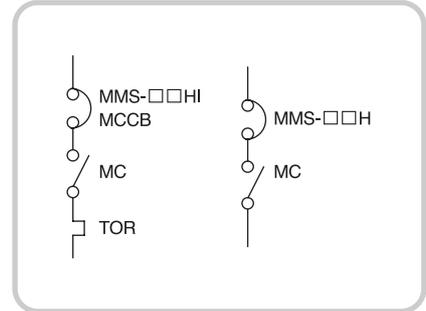

Motor rated power		MCCB, MMS		Con tactor	Thermal Overload Relay		Short circuit breaking capacity	
kW	Rated current(A)	Type (1)	Rating (A)	Type	Type (1)	Setting current (A)	Ir(kA)	Iq(kA)
	500V							
0.06	0.16	MMS-32HI	0.25	MC-9a(b)	MT-12	0.16~0.25	1	30
0.09	0.24	MMS-32HI	0.25	MC-9a(b)	MT-12	0.16~0.25	1	30
0.12	0.32	MMS-32HI	0.4	MC-9a(b)	MT-12	0.25~0.4	1	30
0.18	0.48	MMS-32HI	0.63	MC-9a(b)	MT-12	0.4~0.63	1	30
0.37	0.88	MMS-32HI	1	MC-9a(b)	MT-12	0.63~1	1	30
0.55	1.2	MMS-32HI	1.6	MC-9a(b)	MT-12	1~1.6	1	30
0.75	1.5	MMS-32HI	1.6	MC-9a(b)	MT-12	1~1.6	1	30
1.1	2.2	MMS-32HI	2.5	MC-9a(b)	MT-12	1.6~2.5	1	30
1.5	2.9	MMS-32HI	4	MC-18a(b)	MT-12	2.5~4	1	30
2.2	3.9	MMS-32HI	4	MC-18a(b)	MT-12	2.5~4	1	30
3.0	5.2	MMS-32HI	6	MC-18a(b)	MT-12	4~6	1	30
4.0	6.8	MMS-32HI	8	MC-32a	MT-32	5~8	1	30
5.5	9.2	MMS-32HI	10	MC-32a	MT-32	7~10	1	30
7.5	12.4	MMS-32HI	13	MC-32a	MT-32	9~13	3	30
11.0	17.6	MMS-32HI	22	MC-40a	MT-32	12~18	3	20
15.0	23	MMS-32HI	26	MC-40a	MT-32	18~25	3	20
18.5	28	MMS-32HI	32	MC-40a	MT-32	24~36	3	20
22	33	MMS-63HI	40	MC-50a	MT-63	24~36	3	10
30	44	MMS-63HI	50	MC-50a	MT-63	34~50	3	10
37	53	TD100	63	MC-65a	MT-63	45~65	3	10
45	64	TD100	80	MC-65a	MT-63	45~65	5	10
55	78	TD100	100	MC-85a	MT-95	63~85	5	30

(1) If "H" model is used instead of "HI" model for MMS, use without thermal relay.

L. Standards

1. Verification Organizations and Standards	244
2. Product Standards and Approvals	247
3. KSC IEC60947-4-1 Standard Description	253
4. Acquisition Standard Table	263

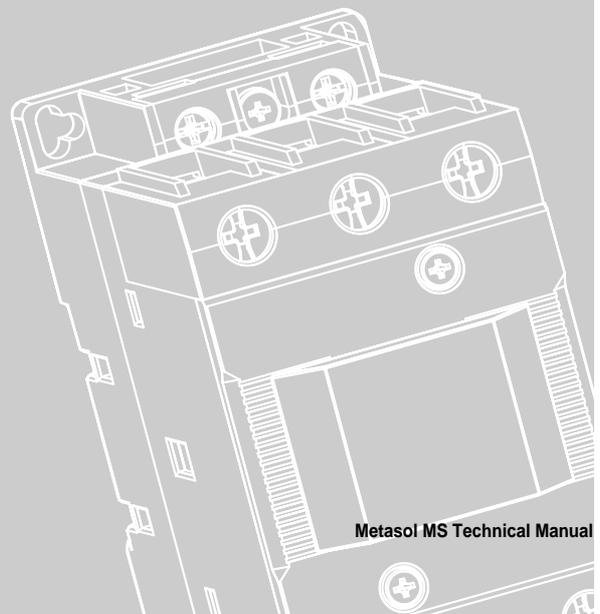

1. Verification Organizations and Standards

1.1 Power Testing & Technology Institute (PT&T)



PT & T was established by LSIS, a Korean heavy electric machinery manufacturer. We have built the first short circuit test facility, high voltage test facility, reliability facility and revision/correction facility of 1600MVA capacity. We have a target of technology development for product performance and reliability improvement, technical specialties in tests and evaluation tasks and fair management. These goals are especially important as an international public test organization and correction organization recognized by KOLAS, we contribute to technological development in the heavy electric machine industry and strive for competitiveness improvement through evaluation of international levels and correction service.

■ Standard certification

KS Korea (Industry) Standard
IEC International Electrotechnical Commission
ES, PS Korea Electric Power Corporation Standards
KEMC Korea Electrical Manufactures's Cooperative Standards
ANSI American National Standards Institute
Etc.

■ Test organization certification

The Power Testing & Technology Institute is recognized as test organization according to the 23rd National standard fundamental law same law enforcement directive and international standard. We are officially recognized national test center which shares test results with other organizations such as UL(American Safety Standards) and CE(European Community Assurance Mark) standard test and also cooperating with overseas test organization such as KEMA of Netherlands , CESI of Italy.
Test cooperative organization : KEMA(Netherlands), CESI(Italy), UL(America) etc

1.2 Standards

International standards

IEC 60947-1	low voltage switch gear and control gear • Part1 : general regulations (NFC63-001)
IEC 60947-4-1	low voltage switch gear and control gear • Part4 : contactor and motor starter • Section1 : electric machinery contactor and motor starter (NFC63-001)
IEC 60947-5-1	low voltage switch gear and control gear • Part5 : control circuit device and switching element • Section1 : electric machinery control circuit device (NFC63-146)
IEC 60947-6-1	low voltage switch gear and control gear • Part6 : multi-function device • Section1 : Automatic transfer switching device (NFC63-160)
IEC 60204-1	Electrical devices of industrial equipment • Part1 : general requirements (NFC79-130)
IEC 60204-2	Electrical devices of industrial equipment • Part2: Item design, drawing, diagram, table and operating example (Publication 204-1' Appendices D and E)

European standards

EN 50 001	industrial low voltage switch gear and control gear • range : General Requirements (NFC63-090)
EN 50 002	industrial low voltage switch gear and control gear • range : Dimensions and Installation of contactor relay Hole (NFC63-091)
EN 50 003	industrial low voltage switch gear and control gear • range : Dimensions and installation of motor contactor Hole (NFC63-092)
EN 50 005	industrial low voltage switch gear and control gear • distinguishing number with element mark: general regulations (NFC63-030)
EN 50 011	industrial low voltage switch gear and control gear • element mark for specified contactor relay, distinguishing number, distinguishing character (NFC 63-031)
EN 50 012	industrial low voltage switch gear and control gear • element mark and distinguishing number for specified contactor's sub contact point (NFC 63-032)
EN 50 022	industrial low voltage switch gear and control gear • installation rail • 35mm width top hat rail of snap-on installation equipment (NFC63-015)
EN 50 023	industrial low voltage switch gear and control gear • 75mm width top hat rail of snap-on installation equipment (NFC63-016)
EN 60 947-1	industrial low voltage switch gear and control gear • Part1 : general regulations (NFC63-001) + revisionA11
EN 60947-4-1	industrial low voltage switch gear and control gear • Part4 : contactor and motor starter • Section1 : electric machinery contactor and motor starter (NFC63-110)
EN 60947-5-1	low voltage switch gear and control gear • Part5 : control circuit device and switching element • Section1 : electric machinery control circuit device (NFC63-146)

1. Verification Organizations and Standards

1.2 Standards

■ National standards

1. Germany : DIN VDE 0660

Part 100	Industrial low-voltage switch gear and control gear <ul style="list-style-type: none"> • general regulations (EN60 947-1) • Part100/A11. revisionA11
Part 102	Electric machinery contactor and motor starter (EN60 947-4-1)
Part 200	Control circuit device and switching element; electric machinery control circuit device (EN60 947-5-1)

2. France

UTE NFC 63-001	Voltage switch gear and control gear <ul style="list-style-type: none"> • : general regulations+ revisionA11 (EN60 947-1 + A11)
UTE NFC 63-110	Voltage switch gear and control gear <ul style="list-style-type: none"> • Part4 : contactor and motor starter • Section1 : electric machines contactor and motor starter (EN60 947-4-1)
UTE NFC 63-140	For control/sub circuit including control switch contactor relays low voltage switching device <ul style="list-style-type: none"> • Part1 - Section1 : general requirements
UTE NFC 63-146	Low voltage switch gear and control gear <ul style="list-style-type: none"> • Part5 : control circuit device and switching element • Section1 : electric machinery control circuit device (EN60 947-5-1)

3. Switzerland: SEV Version

N° 1025	Safety and regulations for contactors
TP 17 B/2A-d	Motor protection and overload protection switch test' s requirements and conditions
TP 17 B/4A-d	Requirements and conditions of motor protection and overload protection switch test' s

4. England

BS 5424 (Part 1)	1000V a.c. and up to 1200V d.c.'s voltage control gear specifications
BS 4794	Including contactor about control circuit 1000V a.c. and up to 1200V d.c switching device (Similar to IEC 337 Publication)
BS 4941	Motor starter about voltage of 1000V a.c. and up to 1200V d.c (Similar to IEC 292 Publication)

5. Sweden

SS 428 0600	Switching device for maximum 1kV, standards investigation <ul style="list-style-type: none"> • International Standards • Switzerland Standards' s effectiveness SS428 0600
--------------------	---

2. Product Standards and Approvals

2.1 Product Standards

■ Standards' suitability

The majority of products of LSIS adhere to international standards (England's BS, France's NF, Germany's DIN) and European standards (CENELEC) or, International Standards (IEC). Product performance designed by this standard is defined in detail (KSC IEC 60947 about low voltage device). Assembling facility, machinery system or installation adhere to product standard is possible, when it is used according to technology rules or regulation with manufacturer's intentions. (for example : IEC 204 related with electric devices which are used in industrial equipment). LSIS can prove the suitability of manufacture to selected standards by quality assurance system, and provide the following depending on requirements.

- Suitability declaration
- Suitability verification (KEMA, DEMCO, TÜV)
- Approval verification and agreement with particular specifications and process

Standard	Standard Name		Country
	Full name	Abbreviation	
ANSI	American National Standards Institute	ANSI	USA
BS	British Standards Institution	BSI	Great Britain
CEI	Comitato Elettrotecnico Italiano	CEI	Italy
DIN/VDE	Verband Deutscher Elektrotechniker	VDE	Germany
EN	Comite Europeen de Normalisation Electrotechnique	CENELEC	Europe
GOST	Gosudarstvennyy komitet Standartov	GOST	Russia
IEC	International Electrotechnical Commission	IEC JISC	Worldwide
JIS	Japanese Industrial Standard	IBN	Japan
NBN	Institut Belge de Normalisation	NNI	Belgium
NEN	Nederlands Normalisatie Instituut	JISC	Netherlands
NFC	Union Technique de l' Electricite	UTE	France
SAA	Standards Association of Australia	SAA	Australia
UNE	Instituto Nacional de Racionalizacion y Normalizacion	IRANOR	Spain

2. Product Standards and Approvals

2.1 Product Standards

■ European EN standards

This is the certification of a related committee inside CENELEC membership countries (EEC and EFTA), the technical specification group is decided there and commonly agreed European standards are established by majority vote. When they conflict with national standards the chosen standards are abolished but otherwise they are combined with national standards. European standards are currently combined with French standards and they have initials such as NF, EN. According to the "Technical Union of Electricity" the French version of European standards which adhere to (UTE) have two marks such as the following. European reference (NF EN ...) and classification (C ...). They can also conform effectively to the French version of standards NF EN 60947-4-1 and European standard EN60947-4-1 related with electric motor and magnetic contactor, magnetic switch and, it takes UTE classification C 63-110. These standards are the same as BS(British Standards) EN 60947-4-1, or German standards DIN VDE 0660 Teil 102. In a rational case, European standards reflect International standards(IEC) all the time. LSIS fulfils the requirements of the French NF standard for essential aspects as well as other industrial countries requirements of automatic system products and line installation devices.

2.2 Regulations

■ European directives

The product introduction into the European market means complying with regulations in each membership country of the European Community. The purpose of European Directives are removing obstacles which disturb the free circulation of products in the European Community, membership countries should enact each directive with their national regulations and abolish violating regulations at the same time. Here the directives related to specified technical contents are decided with the only purpose, they are called "essential requirements". Manufacturers have the responsibility to guarantee that every method which can be applied to specified directive regulation has been applied to the product. The manufacturer verifies with general regulation the suitability about the directive's essential requirements of the product by attaching the CE Mark. LSIS will keep attaching CE Mark continuously throughout the transition period as indicated in French and European regulations.

■ The importance of the CE Mark

The magnetic switch is suitable for export to Europe which is governed according to IEC standards and is suitable for the Low Voltage Directive. The Low Voltage Directive which is one of the European directives became compulsory in January 1997. The CE Mark is attached to products to prove they adhere to European directives for the manufacturer, this ensures the product follows several European directives before it is circulated freely in the European community.

- Low Voltage Directive
 - 73/23/EEC(original text)
 - 93/68/EEC(revised text)
- Type of products to which it can be applied

Operating products with 50~1000VAC/75~1500VDC, CE marking is necessary because it is the target of the low-voltage directive when it is individually exported to Europe.

1. Low voltage directive countermeasure

- 1) CE Mark is necessary for circulation in EU regions with magnetic switch when it is countermeasured to EC directive, in case of magnetic switch is used as a component, but the magnetic switch as a part of an assembled product doesn't require the mark when the CE Mark is marked to machine tool, control device. operational of the third-party recognized product (recognized by KEMA) is recommended in 2), when CEMark is affixed to a control device.
- 2) Magnetic switch's countermeasure as an individual export
Magnetic switch becomes the subject of the low voltage directive in case of individual export inside of EU regions, the low-voltage directive is implimented with module A and suitability certification is basically done by self-declaration.

Applicable product standards are as follows:

EN60947-1	Control device general standards
EN60947-4-1	Magnetic switch standards
EN60947-5-1	Sub-relay standards

The magnetic switch's basic type is a standard, it is suitable for low-voltage directive.

- 3) Third-party recognition (KEMA recognition) aquisition type
When CEMarking to machine tools, control device, operational of magnetic switch of third-party recognized product(KEMA recognition) is recommended as a component for assembly. Magnetic switch aquires KEMA recognition.

2. Other

Machine directives' countermeasure of magnetic switch

Magnetic switch is a part used with machine tools, control devices, it is an exeception for machine directives. operational of magnetic switch of the third-party (KEMA recognition) is recommended in case of affixing the CEMark to machine tools control device. Magnetic switch has aquired KEMA recognition.

2. Product Standards and Approvals

2.2 Regulations

■ KEMA certification

The domestic committee, Netherlands Electrotechnical Committee (NEC) of IEC and CENELEC in The Netherlands is working in the electronic technical field in cooperation with Netherlands Normalisatie Instituut (NNI) through KEMA(KEURING VAN ELECTROTECHNISCHE MATERIALEN : Netherlands electricity test center) in the Netherlands. KEMA is a private corporation which was established to take responsibility for power supply in 1927, for the purpose of investigation of power supply, and testing and checking of electric products in the center of the supply community. KMA currently has two R&D centers, is investigating/pursuing R&D of testing for electric power devices, safety testing of electric heaters, close examination chemical service of electrical standards and all other electricity related fields.

2.3 Approvals

Some countries demand approval of specified electric devices by law, a certificate of approval is issued by a public test organization in this case. Each product should have a related quality label as required.

Standard	Full Name	Country
ASE	Association Suisse des Electriciens	Switzerland
CSA	Canadian Standards Association	Canada
DEMKO	Danmarks Elektriske Materielkontrol	Denmark
FI	Sankotarkastuskeskus Elinspektions Centralen(SETI)	Finland
Underwriters	Norges Elektriske Materielkontrol	Norway
UL	Underwriters Laboratories	USA

UL

The magnetic switch is well suited for export to North America because it has acquired certification from American UL Standard(UL508). We need to be careful with the issued approval from UL(Underwriters Laboratories), because there are two levels of approval. UL is an American organization enacting UL safety standards, testing for safety recognition according to the standard, and issuing certificates and approving labels to the qualifying products. The UL recognized label is applied nationwide in America, UL recognition is required in some major cities, so UL approval is necessary when exporting machinery, control units, and other equipment to America. The magnetic switch has acquired UL part recognition or UL product listing corresponding to control unit UL standard(UL508), so it can be used in control unit equipment exported to America. About UL : UL is a non-profit committee established by the American Insurance Company in 1894. Currently, it's purpose is for protection of property and human life from accidents such as fire, robbery, electrocution, etc. They do this through:

1. Enactment of standards for safety.
2. Individual product tests based on standards.
3. As it is the oldest, largest authority for safety testing in the world it handles the publishing of test results for insurance dealers, government agencies, related communities and general consumers etc. It publishes devices, products, and materials which have UL approval in an annually issued Product Directory, and permits applying the approval mark to approved products of manufacturers.

■ **UL approval mark**

UL approval types	Publication method		Scheme
	Product mark	Publication by UL	
Listing	Listed Mark 	Electrical Construction Materials (electric construction common name : UL Green Book)	<ul style="list-style-type: none"> • It is called recognition, given to product as grouped product which is available to sell to user and use. • white card is issued to manufacturer.
Recognition	Recognition Mark 	Recognized Component (recognized product common name : UL Yellow Book)	<ul style="list-style-type: none"> • It is called condition recognition, can be given to combined and assembled product with other devices. • yellow card is issued to manufacturer.

■ **UL/CUL approval mark**

UL/CUL approval type	Product mark	Scheme
Listing	Listed Mark 	<ul style="list-style-type: none"> • Listing for both America, Canada • UL standard recognition by test organization UL
Recognition	Recognition Mark 	<ul style="list-style-type: none"> • Recognition for both America and Canada • UL, CUL standard recognition by test organization UL • CUL standard product recognition

L

Standards

2. Product Standards and Approvals

2.3 Approvals

■ Marine classification authorities

In case of operational in electric devices intended for a marine environment, pre-approval is generally required from specified marine classification authorities:

Standard abbreviation Mark	Standard name	Scheme
LR	Lloyds register of shipping (english Lloyds Marine classification Association)	<ul style="list-style-type: none"> It is a standard of Lloyds Marine Classification Association with headquarters in London, it has a tradition as classification for marine. Regarding automatic devices used for UMS(Unmanned ship), it has recognition system in the center of environmental test, recognized product is added in the annual recognized list from Lloyds Association.
BV	Bureau veritas (french bureau veritas marine classification association)	<ul style="list-style-type: none"> French marine standard control devices need to be BV recognition acquired products used by AUT with taking approval system for control devices added to the recognition system of circuit breakers like LR standard.
GL	Germanischer Lloyd (german lloyd marine classification association)	<ul style="list-style-type: none"> It is a standard of marine classification association with headquarters in Hamburg Germany, it has nothing to do with English Lloyd's. There are two methods of recognition, the mark below the left hand side in case of unconditional passing, mark is recognized above the left hand side in the case of conditional passing.
NKK	Japanese marine classification association	<ul style="list-style-type: none"> It is stipulated to recognize by a type test about fuse, breaker, explosion-proof machine, magnetic contactor and cables under 600V. It takes recognition test when it is admitted to be suitable by investigating real conditions of entire process's quality management including material, manufacturing method, and investigation standards of company. We can mark the recognized number with the same kinds and shape of product as a recognized product, if it passed the test. Expiration period is four years, recognition system in the center of the environmental test about control devices used for automation of engine room is taken in the near future.

Standard	Full name	Country
BV	Bureau Veritas	France
DNV	Det Norske Veritas	Norway
GL	Germanischer Lloyd	Germany
LR	Lloyd' s Register of Shipping	Great Britain
NKK	Nippon Kaiji Kyokai	Japan
RINA	Registro Italiano navale	Italy
RRS	Register of Shipping	Russia

3. KSC IEC60947-4-1 Standard Description

Item	Standard description contents														
Application range	Device with main contact of which rated voltage doesn't exceed AC1000V, DC 1500V.														
Unbroken distance	Minimum unbroken distance interval														
	Rated insulated voltage of equipment or operational voltage AC RMS value or DC (V) Note4	Unbroken distance interval of equipment depends on long-term stress													
		Degree of contamination			Degree of contamination			Degree of contamination			Degree of contamination				
		1	2	1	2			3			4				
		Material Class			Material Class			Material Class			Material Class				
	Note2	Note3	Note2	Note1	II	IIIa	IIIb	I	II	IIIa	IIIb	I	II	IIIa	IIIb
	10	0.025	0.04	0.08	0.4	0.4	0.4	1	1	1	1.6	1.6	1.6	Note4	
	12.5	0.025	0.04	0.09	0.42	0.42	0.42	1.05	1.05	1.05	1.6	1.6	1.6		
	16	0.025	0.04	0.1	0.45	0.45	0.45	1.1	1.1	1.1	1.63	1.6	1.6		
	20	0.025	0.04	0.11	0.48	0.48	0.48	0.2	1.2	1.2	1.6	1.6	1.6		
	25	0.025	0.04	0.125	0.5	0.5	0.5	0.25	1.25	1.25	1.4	1.7	1.7		
	32	0.025	0.04	0.14	0.53	0.53	0.53	0.3	1.3	1.3	1.8	1.8	1.8		
	40	0.025	0.04	0.16	0.56	0.8	1.1	0.4	1.6	1.8	1.9	2.4	3		
	50	0.025	0.04	0.18	0.6	0.85	1.2	0.5	1.7	1.9	2	2.5	3.2		
	63	0.04	0.063	0.2	0.63	0.9	1.25	0.6	1.8	2	2.1	2.6	3.4		
80	0.063	0.01	0.22	0.67	0.95	1.3	0.7	1.9	2.1	2.2	2.8	3.6			
100	0.1	0.16	0.25	0.71	1	1.4	0.8	2	2.2	2.4	3.0	3.8			
125	0.16	0.25	0.28	0.75	1.05	1.5	0.9	2.1	2.4	2.5	3.25	4			
160	0.25	0.4	0.32	0.8	1.1	1.6	2	2.2	2.5	3.2	4	5			
200	0.4	0.63	0.42	1	1.4	2	2.5	2.8	3.2	4	5	6.3			
250	0.56	1	0.56	1.25	1.8	2.5	3.2	3.6	4	5	6.3	8			
320	0.75	1.6	0.75	1.6	2.2	3.2	4	4.5	5	6.3	8	10			
400	1	2	1	2	2.8	4	5	5.6	6.3	8	10	12.5			
500	0.3	2.5	1.3	2.5	3.6	5	6.3	7.1	8.0	10	12.5	16			
630	0.8	3.2	1.8	3.2	4.5	6.3	8	9	10	12.5	16	20			
800	2.4	4	2.4	4	5.6	8	10	11	12.5	Note4	16	20	25		
1000	3.2	5	3.2	5	7.1	10	12.5	14	16		20	25	32		
1250			4.2	6.3	9	12.5	16	18	20		25	32	40		
1600			5.6	8	11	16	20	22	25		32	40	50		
2000			7.5	10	14	20	25	28	32		40	50	63		
2500			10	12.5	18	25	32	36	40		50	63	80		
3200			12.5	16	22	32	40	45	50		63	80	100		
4000			16	20	28	40	50	56	63		80	100	125		
5000			20	25	36	50	63	71	80		100	125	160		
6300			25	32	45	63	80	90	100		125	160	200		
8000			32	40	56	80	100	110	125		160	200	250		
10000			40	50	71	100	125	140	160		200	250	320		
(Note 1) Class 1, 2, 3a, 3b which are likely to pursuit are reduced by the condition of 10.8 of IEC 60664A. (Note 2) Material class I, II, IIIa, IIIb (Note 3) Material class I, II, IIIa (Note 4) Unbroken distance is not set up in this region. Material class 3b is not generally recommended to apply to degree of contamination 3 and 4 under 630V. (Note 5) Exceptionally, the unbroken distance compatible to the lower value, 125, 400, 630, 800V can be used in case of rated insulation voltage 127, 208, 415, 440, 660/190 and 630V. (Note 6) This given value is applied to the unbroken distance of printed wiring materials from these two columns. Reference1) Tracking or Decay are not expected to occur in the insulation belonging to the working voltage under 32V. But electrolytic decay possibility should be considered, so the minimum unbroken distance is stated for this reason. Reference2) The voltage value is selected with the serial R10															

Standards

3. KSC IEC 60947-4-1 Standard Description

Item	Standard description contents								
Separation distances	Minimum separation distance in the air								
	Rated impulse withstanding voltage uimp(kV)	Minimum separation distance (mm)							
		A type nonhomogeneous electrical field conditions				B type homogeneous electrical field conditions			
		Degree of contamination				Degree of contamination			
		1	2	3	4	1	2	3	4
	0.33	0.01	0.2	0.8	1.6	0.01	0.2	0.8	1.6
	0.5	0.04				0.04			
	0.8	0.1				0.1			
	1.5	0.5	0.5			0.3	0.3		
	2.5	1.5	1.5	1.5		0.6	0.6	1.2	2
4	3	3	3		1.2	1.2	2	3	
6	3.5	5.5	3.5	3	2	2	3	4.5	
8	8	8	8	5.5	3	3	4.5		
12	14	14	14	14	4.5	4.5			
	Reference) The minimum separation distance in the air is based on impulse voltage, 1.2/50ms barometric pressure of 80kpa such as normal air pressure at 2000m above sea level.								
Rated impulse withstanding voltage and switching overload voltage	<p>Manufacturer can declare rated impulse withstanding voltage (Uimp). Recommended value (kV) : 0.33, 0.5, 0.8, 1.5, 2.5, 4, 6, 8, 12</p> <p>Insulation distance is the first attached tag 13, 15 incase of declaration, and the device shouldn't generate switching overload voltage higher than rated impulse withstanding voltage. Or impulse withstanding voltage test of transfer test implies the duty.</p>								
Rated operational current or rated operational power	Rated operational current is indicated including protection type by rated operational voltage, open current, closed thermal current, rated current of overload relay, rated frequency, rated duty, rated load type and enclosure. The manufacturer should necessarily prepare the relation indication of current and power in case of switching of each electrical motor.								
Open thermal current	The open thermal current in an eight hour duty should be at least the same as the maximum value of the rated operational current of the open-type device.								
Closed thermal current and insulation distance	A closed-type thermal current in an eight hour duty shouldn't be less than the maximum value of the rated operational current of closed-type equipment.								

Item	Standard description contents										
Rated continuous current	Current flow for more than eight hours without breaking, and under the condition without current flow										
Operational load type	<table border="0"> <tr> <td style="vertical-align: top;"> AC-1 Non-inductive or low conductive load resistance furnace. AC-2 Wound rotor type motor: start, stop AC-3 Squirrel-cage motor: during starting, driving AC-4 Squirrel-cage motor:driving, plugging, inching AC-5b Incandescent lamp switching AC-6a Transformer switching AC-6b Condenser bank switching AC-7a Low-inductive load in home appliances or other similar cases AC-7b Electrical motor load for home appliances AC-8a Hand-reset type overload sealed type Freezing compressor motor control AC-8b Automatic reset type overload sealed type Freezing compressor motor control </td> <td style="vertical-align: top; border-left: 1px dotted black;"> DC-1 Non-conductive or low-resistance furnace. conductive load resistance furnace DC-3 Shunt motor: start, plugging, inching, stop, dynamic suspension DC-5 Series motor: start, plugging, driving inching, dynamic suspension DC-6 Incandescent lamp switching </td> </tr> </table>	AC-1 Non-inductive or low conductive load resistance furnace. AC-2 Wound rotor type motor: start, stop AC-3 Squirrel-cage motor: during starting, driving AC-4 Squirrel-cage motor:driving, plugging, inching AC-5b Incandescent lamp switching AC-6a Transformer switching AC-6b Condenser bank switching AC-7a Low-inductive load in home appliances or other similar cases AC-7b Electrical motor load for home appliances AC-8a Hand-reset type overload sealed type Freezing compressor motor control AC-8b Automatic reset type overload sealed type Freezing compressor motor control	DC-1 Non-conductive or low-resistance furnace. conductive load resistance furnace DC-3 Shunt motor: start, plugging, inching, stop, dynamic suspension DC-5 Series motor: start, plugging, driving inching, dynamic suspension DC-6 Incandescent lamp switching								
AC-1 Non-inductive or low conductive load resistance furnace. AC-2 Wound rotor type motor: start, stop AC-3 Squirrel-cage motor: during starting, driving AC-4 Squirrel-cage motor:driving, plugging, inching AC-5b Incandescent lamp switching AC-6a Transformer switching AC-6b Condenser bank switching AC-7a Low-inductive load in home appliances or other similar cases AC-7b Electrical motor load for home appliances AC-8a Hand-reset type overload sealed type Freezing compressor motor control AC-8b Automatic reset type overload sealed type Freezing compressor motor control	DC-1 Non-conductive or low-resistance furnace. conductive load resistance furnace DC-3 Shunt motor: start, plugging, inching, stop, dynamic suspension DC-5 Series motor: start, plugging, driving inching, dynamic suspension DC-6 Incandescent lamp switching										
Switching frequency (intermittant duty)	Driver: 1, 3, 6, 12, 30, 120, 300, 1200(times / hour) Contactor: 1, 3, 12, 30(times / hour)										
Sub circuit	The characteristic of the sub-contact or sub-switch follows the requirements IEC60947- 5 (please refer to part 1).										
Thermal overload relay	<table border="1" style="width: 100%; border-collapse: collapse;"> <thead> <tr> <th style="width: 30%;">Trip Class</th> <th style="width: 70%;">Driving time at 720% current of set current Tp(s)</th> </tr> </thead> <tbody> <tr> <td style="text-align: center;">10A</td> <td style="text-align: center;">$2 < T_p \leq 10$</td> </tr> <tr> <td style="text-align: center;">10</td> <td style="text-align: center;">$4 < T_p \leq 10$</td> </tr> <tr> <td style="text-align: center;">20</td> <td style="text-align: center;">$6 < T_p \leq 20$</td> </tr> <tr> <td style="text-align: center;">30</td> <td style="text-align: center;">$9 < T_p \leq 30$</td> </tr> </tbody> </table>	Trip Class	Driving time at 720% current of set current Tp(s)	10A	$2 < T_p \leq 10$	10	$4 < T_p \leq 10$	20	$6 < T_p \leq 20$	30	$9 < T_p \leq 30$
Trip Class	Driving time at 720% current of set current Tp(s)										
10A	$2 < T_p \leq 10$										
10	$4 < T_p \leq 10$										
20	$6 < T_p \leq 20$										
30	$9 < T_p \leq 30$										
Cooperation with short circuit protection device (SCPD)	Confirmation of protection cooperation is required depending on short-circuit test at the part indicated type, rating, characteristic of SCPD										



Standards

3. KSC IEC 60947-4-1 Standard Description

Item	Standard description contents				
Temperature Increase	<p>Main circuit of contactor or starter at ON position are implemented with combination overcurrent trip device. Every sub-circuit flowing common current, load at maximum rated operational current, applied control circuit are excited to rated voltage. It should not be over temperature increase as in the following table, should flow the following current. In case of continuous duty : open thermal current or closed current In case of continuous duty intermittent temporary duty : related rated operational current</p>				
	Types			Temperature increase (K)	
				Thermometer method	Resistance method
	Terminal	copper		60	-
		copper alloy		65	-
		tinning copper, copper alloy		65	-
		silver plating, nickel plating copper, or copper alloy		70	-
		other		(65)	70
	Coil	aerial	A	-	85
			E	-	100
			B	-	110
			F	-	135
H			-	160	
hydraulic		A E B	-	60	
Possible part for connection	manual control part (holding part)	Metal	15	-	
		Non-metal	25	-	
	contact but no hold	Metal	30	-	
		Non-metal	40	-	
commonly used in location without human contact	Metal	40	-		
	Non-metal	50	-		
Other	insulation material		Insulation temperature rating follows the reference IEC 6008		
Operation	<p>Starter shouldn't be tripped by the shock during rapid three-time operation from normal switching order, after starter using the contactor reaches thermal equilibrium by flowing rated entire load current about maximum and minimum, both directions of thermal relay when it can be controlled about standard surrounding temperature +20°C. The contactor should be opened by tripping device operation as the closed circuit of contactor in case of thermal overload relay equipped with stop and trip device.</p>				
Operation Limit of Contactor	<p>1. Closed Circuit After temperature saturation with continuous application of 100% Us to coil at surrounding temperature 40°C, precisely possible for closed circuit at 86%~100% of Us(rated control power voltage).</p> <p>2. Open Circuit It is opened entirely at 75~20% of Us in AC, 75~10% in DC at the surrounding temperature of -5°C(normally it can be verified by calculation based on the value from surrounding temperature) and opened entirely.</p>				

Item	Standard Description Contents						
Overload thermal relay operating limit	1. The range of current flow to every pole						
		Condition	Surrounding temperature compensation			Evaluation	
			none	exists	Trip class	Operation time	
	multiple of setting current	A. Cold start	1.0	1.05		no operation for 2 hrs	
		B. Continuous from A	1.2	1.2		operation within 2 hrs	
		C. Hot Start	1.5	1.5	10A 10 20 30	operation less than 2 min operation less than 4 min operation less than 8 min operation less than 12 min	
		D. Cold Start	7.2	7.2	5 10A 10 20 30	Tp ≤ 5s 2 ≤ Tp ≤ 10s 4 ≤ Tp ≤ 10s 6 ≤ Tp ≤ 20s 9 ≤ Tp ≤ 30s	
	standard surrounding temperature		+40°C	+20°C			
	2. 2 Three-pole TOR operation characteristic range with two-pole current flow						
		condition				Evaluation	
		Surrounding temperature compensation	attach.	none	attach.	Trip class	Operation time class
	Open phase detection	none	none	attach.			
	Multiple of setting current	A. Cold Start	3 pole 1.0	3 pole 1.0	2 pole 1.0 1 pole 0.9	all	no operation for 2 hours
		B. A continuous	2 pole 1.32 1 pole 0	2 pole 1.25 1 pole 0	2 pole 1.15 1 pole 0	all	operation within 2 hours
	Standard surrounding temperature		+20°C	+40°C	+20°C		
Note) Connected wire size is chosen from the following test current trip class 10A: 100% of setting current trip class 10,20,30 : 125% of setting current							
Withstanding voltage	Test voltage is sine wave 45~65Hz, apply the following value in the table for one minute.						
	Rated insulation voltage Ui(V)			Withstanding voltage test voltage(rmsV)			
	Ui ≤ 60			1000			
	60 < Ui ≤ 300			2000			
	300 < Ui ≤ 690			2500			
	690 < Ui ≤ 800			3000			
	800 < Ui ≤ 1000			3500			
1000 < Ui ≤ 1500 (DC only)			3500				
Note) It is an exception when the manufacturer declares rated impulse with standard voltage value.							

3. KSC IEC 60947-4-1 Standard Description

Item	Standard description contents																																																																																																	
Insulation resistance	No regulation																																																																																																	
Rated closed circuit and breaking capacity	<p>Rated closed-circuit breaking capacity condition depends on operational load type.</p> <table border="1"> <thead> <tr> <th rowspan="2">Type of operational load</th> <th colspan="6">Closed circuit and breaking condition</th> </tr> <tr> <th>I_c/I_e</th> <th>U_r/U_e</th> <th>cos ∅ or L/R</th> <th>ON time(s)</th> <th>OFF time(s)</th> <th>Operating Cycle(times)</th> </tr> </thead> <tbody> <tr> <td>AC-1</td> <td>1.5</td> <td>1.05</td> <td>0.8</td> <td>0.05</td> <td>(Note1)</td> <td>50</td> </tr> <tr> <td>AC-3</td> <td>8</td> <td>1.05</td> <td>(Note2)</td> <td>0.05</td> <td>(Note1)</td> <td>50</td> </tr> <tr> <td>AC-4</td> <td>10</td> <td>1.05</td> <td>(Note2)</td> <td>0.05</td> <td>(Note1)</td> <td>50</td> </tr> <tr> <td>DC-1</td> <td>1.5</td> <td>1.05</td> <td>1.0ms</td> <td>0.05</td> <td>(Note1)</td> <td>(Note3)</td> </tr> <tr> <td>DC-5</td> <td>4</td> <td>1.05</td> <td>15.0ms</td> <td>0.05</td> <td>(Note1)</td> <td>(Note3)</td> </tr> </tbody> </table> <table border="1"> <thead> <tr> <th rowspan="2">Type of operational load</th> <th colspan="6">Closed circuit condition</th> </tr> <tr> <th>I_c/I_e</th> <th>U/U_e</th> <th>cos ∅</th> <th>ON time(s)</th> <th>OFF time(s)</th> <th>Operating Cycle(times)</th> </tr> </thead> <tbody> <tr> <td>AC-3</td> <td>10</td> <td>1.05</td> <td>(Note2)</td> <td>0.05</td> <td>10</td> <td>50(Note4)</td> </tr> <tr> <td>AC-4</td> <td>12</td> <td>1.05</td> <td>(Note2)</td> <td>0.05</td> <td>10</td> <td>50(Note4)</td> </tr> </tbody> </table> <p>I : closed circuit, I_c : closed circuit breaking current, I_e : rated operational current, U : applied voltage, U_r : Commercial frequency or DC reset voltage, U_e : Rated operational voltage Note 1) Relation between breaking current and off time</p> <table border="1"> <thead> <tr> <th>Breaking current I_c (A)</th> <th>OFF time (sec)</th> </tr> </thead> <tbody> <tr> <td>I_c ≤ 100</td> <td>10</td> </tr> <tr> <td>100 < I_c ≤ 200</td> <td>20</td> </tr> <tr> <td>200 < I_c ≤ 300</td> <td>30</td> </tr> <tr> <td>300 < I_c ≤ 400</td> <td>40</td> </tr> <tr> <td>400 < I_c ≤ 600</td> <td>60</td> </tr> <tr> <td>600 < I_c ≤ 800</td> <td>80</td> </tr> <tr> <td>800 < I_c ≤ 1000</td> <td>100</td> </tr> <tr> <td>1000 < I_c ≤ 1300</td> <td>140</td> </tr> <tr> <td>1300 < I_c ≤ 1600</td> <td>180</td> </tr> <tr> <td>1600 < I_c</td> <td>240</td> </tr> </tbody> </table> <p>Note 2) I_e ≤ 100A: 0.45 I_e > 100A : 0.35 Note 3) One-sided polarity : 25 times, counter-polarity : 25 times Note 4) 1.1U_s: 25 times, 0.85U_s : 25 times</p>	Type of operational load	Closed circuit and breaking condition						I _c /I _e	U _r /U _e	cos ∅ or L/R	ON time(s)	OFF time(s)	Operating Cycle(times)	AC-1	1.5	1.05	0.8	0.05	(Note1)	50	AC-3	8	1.05	(Note2)	0.05	(Note1)	50	AC-4	10	1.05	(Note2)	0.05	(Note1)	50	DC-1	1.5	1.05	1.0ms	0.05	(Note1)	(Note3)	DC-5	4	1.05	15.0ms	0.05	(Note1)	(Note3)	Type of operational load	Closed circuit condition						I _c /I _e	U/U _e	cos ∅	ON time(s)	OFF time(s)	Operating Cycle(times)	AC-3	10	1.05	(Note2)	0.05	10	50(Note4)	AC-4	12	1.05	(Note2)	0.05	10	50(Note4)	Breaking current I _c (A)	OFF time (sec)	I _c ≤ 100	10	100 < I _c ≤ 200	20	200 < I _c ≤ 300	30	300 < I _c ≤ 400	40	400 < I _c ≤ 600	60	600 < I _c ≤ 800	80	800 < I _c ≤ 1000	100	1000 < I _c ≤ 1300	140	1300 < I _c ≤ 1600	180	1600 < I _c	240
	Type of operational load		Closed circuit and breaking condition																																																																																															
		I _c /I _e	U _r /U _e	cos ∅ or L/R	ON time(s)	OFF time(s)	Operating Cycle(times)																																																																																											
	AC-1	1.5	1.05	0.8	0.05	(Note1)	50																																																																																											
	AC-3	8	1.05	(Note2)	0.05	(Note1)	50																																																																																											
	AC-4	10	1.05	(Note2)	0.05	(Note1)	50																																																																																											
	DC-1	1.5	1.05	1.0ms	0.05	(Note1)	(Note3)																																																																																											
	DC-5	4	1.05	15.0ms	0.05	(Note1)	(Note3)																																																																																											
	Type of operational load	Closed circuit condition																																																																																																
		I _c /I _e	U/U _e	cos ∅	ON time(s)	OFF time(s)	Operating Cycle(times)																																																																																											
AC-3	10	1.05	(Note2)	0.05	10	50(Note4)																																																																																												
AC-4	12	1.05	(Note2)	0.05	10	50(Note4)																																																																																												
Breaking current I _c (A)	OFF time (sec)																																																																																																	
I _c ≤ 100	10																																																																																																	
100 < I _c ≤ 200	20																																																																																																	
200 < I _c ≤ 300	30																																																																																																	
300 < I _c ≤ 400	40																																																																																																	
400 < I _c ≤ 600	60																																																																																																	
600 < I _c ≤ 800	80																																																																																																	
800 < I _c ≤ 1000	100																																																																																																	
1000 < I _c ≤ 1300	140																																																																																																	
1300 < I _c ≤ 1600	180																																																																																																	
1600 < I _c	240																																																																																																	
Operation characteristics	<p>Regulated operation characteristic of closed circuit, breaking conditions about operational load type.</p> <table border="1"> <thead> <tr> <th rowspan="2">Operational load type</th> <th colspan="6">Test condition of closed circuit and Breaking</th> </tr> <tr> <th>I_c/I_e</th> <th>U_r/U_e</th> <th>cos ∅ or L/R</th> <th>ON time(s)</th> <th>OFF time(s)</th> <th>Operating cycle(times)</th> </tr> </thead> <tbody> <tr> <td>AC-1</td> <td>1</td> <td>1.05</td> <td>0.8</td> <td>0.05</td> <td>(Note1)</td> <td>6000</td> </tr> <tr> <td>AC-3</td> <td>2</td> <td>1.05</td> <td>(Note2)</td> <td>0.05</td> <td>(Note1)</td> <td>6000</td> </tr> <tr> <td>AC-4</td> <td>6</td> <td>1.05</td> <td>(Note2)</td> <td>0.05</td> <td>(Note1)</td> <td>6000</td> </tr> <tr> <td>DC-1</td> <td>1</td> <td>1.05</td> <td>1.0ms</td> <td>0.05</td> <td>(Note1)</td> <td>50(Note3)</td> </tr> <tr> <td>DC-5</td> <td>2.5</td> <td>1.05</td> <td>7.5ms</td> <td>0.05</td> <td>(Note1)</td> <td>50(Note3)</td> </tr> </tbody> </table> <p>Note1) Note 2) Same as closed circuit, closed circuit capacity table Note 3) One-sided polarity : 3000 times, Counter-polarity 3000 times</p>	Operational load type	Test condition of closed circuit and Breaking						I _c /I _e	U _r /U _e	cos ∅ or L/R	ON time(s)	OFF time(s)	Operating cycle(times)	AC-1	1	1.05	0.8	0.05	(Note1)	6000	AC-3	2	1.05	(Note2)	0.05	(Note1)	6000	AC-4	6	1.05	(Note2)	0.05	(Note1)	6000	DC-1	1	1.05	1.0ms	0.05	(Note1)	50(Note3)	DC-5	2.5	1.05	7.5ms	0.05	(Note1)	50(Note3)																																																	
	Operational load type		Test condition of closed circuit and Breaking																																																																																															
		I _c /I _e	U _r /U _e	cos ∅ or L/R	ON time(s)	OFF time(s)	Operating cycle(times)																																																																																											
	AC-1	1	1.05	0.8	0.05	(Note1)	6000																																																																																											
	AC-3	2	1.05	(Note2)	0.05	(Note1)	6000																																																																																											
	AC-4	6	1.05	(Note2)	0.05	(Note1)	6000																																																																																											
	DC-1	1	1.05	1.0ms	0.05	(Note1)	50(Note3)																																																																																											
DC-5	2.5	1.05	7.5ms	0.05	(Note1)	50(Note3)																																																																																												

Item	Standard description contents																																																																																		
Durability	<p>1. Mechanical Durability Verified with special test Condition : 1) Unloaded switching 2) Applying rated voltage, frequency at control coil 3) Switching frequency is countermeasured type 4) No part replacement</p> <p>Result : Contactor, thermal overload relay satisfies performance limit test. at room temperature, no wire loosening. Statistically one out of the following two tests is implemented</p> <ul style="list-style-type: none"> • Single 8 test : 8 product test, passing when there are less than two product failures • Double 3 test : 3 product test, failure if there are more than two product failures <p>If additional 3 products are passed, in case of 1 failure, it passes The recommended value of operation times(1,000,000 times)</p> <ul style="list-style-type: none"> • 0001, 0.003, 0.01, 0.03, 0.1, 0.3, 1, 3, 10 <p>2. Electrical Durability Verified with special test. Attaching countermeasured condition depends on operational load type mechanical durability condition is 2) 3) 4) except for operational load type test condition are as follows</p> <table border="1" data-bbox="628 1137 1420 1397"> <thead> <tr> <th rowspan="2">Operational load type</th> <th rowspan="2">Rated Operational current</th> <th colspan="3">Closed circuit</th> <th colspan="3">Breaking</th> </tr> <tr> <th>I/Ie</th> <th>U/Ue</th> <th>Power factor</th> <th>Ic/Ie</th> <th>Ur/Ue</th> <th>Power factor</th> </tr> </thead> <tbody> <tr> <td>AC-1</td> <td>Total</td> <td>1</td> <td>1</td> <td>0.95</td> <td>1</td> <td>1</td> <td>0.95</td> </tr> <tr> <td rowspan="2">AC-3</td> <td>$I_e \leq 17$</td> <td>6</td> <td>1</td> <td>0.65</td> <td>1</td> <td>0.17</td> <td>0.65</td> </tr> <tr> <td>$17 < I_e$</td> <td>6</td> <td>1</td> <td>0.35</td> <td>1</td> <td>0.17</td> <td>0.35</td> </tr> <tr> <td rowspan="2">AC-4</td> <td>$I_e \leq 17$</td> <td>6</td> <td>1</td> <td>0.65</td> <td>6</td> <td>1</td> <td>0.65</td> </tr> <tr> <td>$17 < I_e$</td> <td>6</td> <td>1</td> <td>0.35</td> <td>6</td> <td>1</td> <td>0.35</td> </tr> </tbody> </table> <table border="1" data-bbox="628 1402 1420 1550"> <thead> <tr> <th rowspan="2">Operational load type</th> <th rowspan="2">Rated Operational current</th> <th colspan="3">Closed circuit</th> <th colspan="3">Breaking</th> </tr> <tr> <th>I/Ie</th> <th>U/Ue</th> <th>time constant</th> <th>Ic/Ie</th> <th>Ur/Ue</th> <th>time constant</th> </tr> </thead> <tbody> <tr> <td>DC-1</td> <td>entirely</td> <td>1</td> <td>1</td> <td>1ms</td> <td>1</td> <td>1</td> <td>1ms</td> </tr> <tr> <td>DC-5</td> <td>entirely</td> <td>2.5</td> <td>1</td> <td>7.5ms</td> <td>2.5</td> <td>1</td> <td>7.5ms</td> </tr> </tbody> </table> <p>Result Contactor or starter after test should endure within the voltage twice that of rated operational voltage Ue satisfying operation limit test (minimum 900V).</p>	Operational load type	Rated Operational current	Closed circuit			Breaking			I/Ie	U/Ue	Power factor	Ic/Ie	Ur/Ue	Power factor	AC-1	Total	1	1	0.95	1	1	0.95	AC-3	$I_e \leq 17$	6	1	0.65	1	0.17	0.65	$17 < I_e$	6	1	0.35	1	0.17	0.35	AC-4	$I_e \leq 17$	6	1	0.65	6	1	0.65	$17 < I_e$	6	1	0.35	6	1	0.35	Operational load type	Rated Operational current	Closed circuit			Breaking			I/Ie	U/Ue	time constant	Ic/Ie	Ur/Ue	time constant	DC-1	entirely	1	1	1ms	1	1	1ms	DC-5	entirely	2.5	1	7.5ms	2.5	1	7.5ms
Operational load type	Rated Operational current			Closed circuit			Breaking																																																																												
		I/Ie	U/Ue	Power factor	Ic/Ie	Ur/Ue	Power factor																																																																												
AC-1	Total	1	1	0.95	1	1	0.95																																																																												
AC-3	$I_e \leq 17$	6	1	0.65	1	0.17	0.65																																																																												
	$17 < I_e$	6	1	0.35	1	0.17	0.35																																																																												
AC-4	$I_e \leq 17$	6	1	0.65	6	1	0.65																																																																												
	$17 < I_e$	6	1	0.35	6	1	0.35																																																																												
Operational load type	Rated Operational current	Closed circuit			Breaking																																																																														
		I/Ie	U/Ue	time constant	Ic/Ie	Ur/Ue	time constant																																																																												
DC-1	entirely	1	1	1ms	1	1	1ms																																																																												
DC-5	entirely	2.5	1	7.5ms	2.5	1	7.5ms																																																																												
Overload current limit quantity of contactor	<p>AC-3 or AC-4 contactors should endure the given overload current from the following. Test implements with arbitrary voltage, contactor starts the test at room temperature. Verify that the contactor after test is in the same condition as before the test with a naked eye investigation.</p> <table border="1" data-bbox="628 1861 1420 1973"> <thead> <tr> <th>Rated operational current</th> <th>Test current "r"</th> <th>Test time</th> </tr> </thead> <tbody> <tr> <td>$I_e \leq 630A$</td> <td>$8 \times I_e \text{ max / AC-3}$</td> <td>10 s</td> </tr> <tr> <td>$630A < I_e$</td> <td>$6 \times I_e \text{ max / AC-3}^*)$</td> <td>10 s</td> </tr> </tbody> </table> <p>* Minimum value is 5040A</p>	Rated operational current	Test current "r"	Test time	$I_e \leq 630A$	$8 \times I_e \text{ max / AC-3}$	10 s	$630A < I_e$	$6 \times I_e \text{ max / AC-3}^*)$	10 s																																																																									
Rated operational current	Test current "r"	Test time																																																																																	
$I_e \leq 630A$	$8 \times I_e \text{ max / AC-3}$	10 s																																																																																	
$630A < I_e$	$6 \times I_e \text{ max / AC-3}^*)$	10 s																																																																																	

3. KSC IEC 60947-4-1 Standard Description

Item	Standard description contents																																													
<p style="text-align: center;">Cooperation with short circuit protection device(SCPD)</p> <p>1) Short circuit condition part</p>	<p>A contactor with a backup to a short circuit protection device and short circuit current at the regular condition part of starter should be verified by short circuit test.</p> <p>Estimated current "r" of rated operational current</p> <table border="1" data-bbox="632 584 1418 808"> <thead> <tr> <th data-bbox="632 584 826 658">C</th> <th data-bbox="826 584 1023 658">Estimated current "r" kA</th> <th data-bbox="1023 584 1219 658">Estimated current "r" kA</th> <th data-bbox="1219 584 1418 658">Estimated current "r" kA</th> </tr> </thead> <tbody> <tr> <td data-bbox="632 658 826 696">0 < I_e ≤ 16</td> <td data-bbox="826 658 1023 696">1</td> <td data-bbox="1023 658 1219 696">315 < I_e ≤ 630</td> <td data-bbox="1219 658 1418 696">18</td> </tr> <tr> <td data-bbox="632 696 826 734">16 < I_e ≤ 63</td> <td data-bbox="826 696 1023 734">3</td> <td data-bbox="1023 696 1219 734">630 < I_e ≤ 1000</td> <td data-bbox="1219 696 1418 734">30</td> </tr> <tr> <td data-bbox="632 734 826 772">63 < I_e ≤ 125</td> <td data-bbox="826 734 1023 772">5</td> <td data-bbox="1023 734 1219 772">1000 < I_e ≤ 1600</td> <td data-bbox="1219 734 1418 772">42</td> </tr> <tr> <td data-bbox="632 772 826 808">125 < I_e ≤ 315</td> <td data-bbox="826 772 1023 808">10</td> <td data-bbox="1023 772 1219 808">1600 < I_e</td> <td data-bbox="1219 772 1418 808">* *</td> </tr> </tbody> </table> <p>* If no AC-3 designation, rated operational current at maximum</p> <p>** According to agreement between manufacturer and user. Coordination is distinguished type 1 or type 2 short circuit test is implemented with estimated current "r" or short circuit current "iq" higher than "r" at rated condition part designated by manufacturer.</p> <table border="1" data-bbox="632 1003 1418 1697"> <thead> <tr> <th data-bbox="632 1003 775 1041"></th> <th data-bbox="775 1003 1098 1041">Type 1</th> <th data-bbox="1098 1003 1418 1041">Type 2</th> </tr> </thead> <tbody> <tr> <td data-bbox="632 1041 775 1220">Performance</td> <td data-bbox="775 1041 1098 1220"> <ul style="list-style-type: none"> It isn't harmful to humans or the facility. Part replacement and repair is possible. </td> <td data-bbox="1098 1041 1418 1220"> <ul style="list-style-type: none"> It isn't harmful to humans or the facility. Continuous operational is possible (contact melting and fusion is allowed) </td> </tr> <tr> <td data-bbox="632 1220 775 1294" rowspan="2">Test conditions</td> <td data-bbox="775 1220 1098 1294">O^{Note1)} CO^{Note2)}</td> <td data-bbox="1098 1220 1418 1294">O-CO</td> </tr> <tr> <td data-bbox="775 1294 1098 1332">test with each new product</td> <td data-bbox="1098 1294 1418 1332">test with one new product</td> </tr> <tr> <td data-bbox="632 1332 775 1697" rowspan="4">Evaluation</td> <td colspan="2" data-bbox="775 1332 1418 1348">A. Arc detection fuse, no connection conductor heater fusing.</td> </tr> <tr> <td colspan="2" data-bbox="775 1348 1418 1400">C. No damage to conductor, terminal and conductor should not be excluded from the terminal.</td> </tr> <tr> <td colspan="2" data-bbox="775 1400 1418 1438">D. No crack at insulating stand</td> </tr> <tr> <td data-bbox="775 1438 1098 1541">H. Damage of main body is possible carry-out of part is impossible</td> <td data-bbox="1098 1438 1418 1541">J. Main body damage is impossible Contact melting and fusion is possible</td> </tr> <tr> <td data-bbox="632 1541 775 1697" rowspan="2"></td> <td data-bbox="775 1541 1098 1630">I. It satisfies withstanding voltage 2x U_e for one minute (min1000V)</td> <td data-bbox="1098 1541 1418 1630">K. TOR's characteristic satisfies characteristic curve</td> </tr> <tr> <td data-bbox="775 1630 1098 1697"></td> <td data-bbox="1098 1630 1418 1697">It satisfies withstanding voltage 2x U_e for one minute</td> </tr> </tbody> </table> <p>Note 1) Breaking by flowing current with protection device after circuit closing the main body contact. Note 2) Breaking by flowing current with protection device after circuit closing the short circuit current at main body contact.</p>	C	Estimated current "r" kA	Estimated current "r" kA	Estimated current "r" kA	0 < I _e ≤ 16	1	315 < I _e ≤ 630	18	16 < I _e ≤ 63	3	630 < I _e ≤ 1000	30	63 < I _e ≤ 125	5	1000 < I _e ≤ 1600	42	125 < I _e ≤ 315	10	1600 < I _e	* *		Type 1	Type 2	Performance	<ul style="list-style-type: none"> It isn't harmful to humans or the facility. Part replacement and repair is possible. 	<ul style="list-style-type: none"> It isn't harmful to humans or the facility. Continuous operational is possible (contact melting and fusion is allowed) 	Test conditions	O ^{Note1)} CO ^{Note2)}	O-CO	test with each new product	test with one new product	Evaluation	A. Arc detection fuse, no connection conductor heater fusing.		C. No damage to conductor, terminal and conductor should not be excluded from the terminal.		D. No crack at insulating stand		H. Damage of main body is possible carry-out of part is impossible	J. Main body damage is impossible Contact melting and fusion is possible		I. It satisfies withstanding voltage 2x U _e for one minute (min1000V)	K. TOR's characteristic satisfies characteristic curve		It satisfies withstanding voltage 2x U _e for one minute
	C	Estimated current "r" kA	Estimated current "r" kA	Estimated current "r" kA																																										
0 < I _e ≤ 16	1	315 < I _e ≤ 630	18																																											
16 < I _e ≤ 63	3	630 < I _e ≤ 1000	30																																											
63 < I _e ≤ 125	5	1000 < I _e ≤ 1600	42																																											
125 < I _e ≤ 315	10	1600 < I _e	* *																																											
	Type 1	Type 2																																												
Performance	<ul style="list-style-type: none"> It isn't harmful to humans or the facility. Part replacement and repair is possible. 	<ul style="list-style-type: none"> It isn't harmful to humans or the facility. Continuous operational is possible (contact melting and fusion is allowed) 																																												
Test conditions	O ^{Note1)} CO ^{Note2)}	O-CO																																												
	test with each new product	test with one new product																																												
Evaluation	A. Arc detection fuse, no connection conductor heater fusing.																																													
	C. No damage to conductor, terminal and conductor should not be excluded from the terminal.																																													
	D. No crack at insulating stand																																													
	H. Damage of main body is possible carry-out of part is impossible	J. Main body damage is impossible Contact melting and fusion is possible																																												
	I. It satisfies withstanding voltage 2x U _e for one minute (min1000V)	K. TOR's characteristic satisfies characteristic curve																																												
		It satisfies withstanding voltage 2x U _e for one minute																																												
<p style="text-align: center;">Degree of contamination</p>	<p>Contactor and starter are used under the environment of degree of contamination 3 without designation by manufacturer. But, other degrees of contamination may be applied depending on clean environmental conditions.</p> <p>Contamination Level 3 : There is contamination with conductive characteristics. Or it becomes conductive because of circuit disconnection, but normally dry non-conductive contamination happens.</p>																																													

Item	Standard description contents																																																																					
<p>Test sequence</p>	<p>Test Sequence I (1) Temperature (2) Operation and operation limit (3) Insulation characteristic (withstanding voltage)</p>																																																																					
	<p>Test Sequence II (1) Cosed circuit (2)closed circuit and breaking (3) Performance characteristic [(1) is omitted when AC-1]</p>																																																																					
	<p>Test Sequence III (1) Short Circuit Test Starter which doesn't appear overcurrent operation cooperation between starter and short-circuit protection device by type of SCPD, rating and characteristic can be replaced with overload limit quantity test.</p>																																																																					
	<p>Test Sequence IV (1) Overload current limit quantity</p>																																																																					
<p>Terminal structure</p>	<p>Mechanical terminal strength test, terminal curvature test, tensile test, ring shaped conductor insertion test are necessary.</p>																																																																					
<p>Connection capacity</p>	<p>The manufacturer indicates that the maximum and minimum sectional area of conductive part which is supplied to type(hard solid or flexible) and the number of conductors which is possible to connect to the terminal at one time.</p>																																																																					
	<table border="1"> <thead> <tr> <th colspan="3" data-bbox="628 1137 1417 1173">< ISO/AWG ></th> </tr> <tr> <th data-bbox="628 1173 890 1249">Test current A</th> <th data-bbox="890 1173 1155 1249">ISO mm²</th> <th data-bbox="1155 1173 1417 1249">AWG MCM</th> </tr> </thead> <tbody> <tr><td data-bbox="628 1249 890 1285">0 < I ≤ 8</td><td data-bbox="890 1249 1155 1285">1.0</td><td data-bbox="1155 1249 1417 1285">18</td></tr> <tr><td data-bbox="628 1285 890 1321">8 < I ≤ 12</td><td data-bbox="890 1285 1155 1321">1.5</td><td data-bbox="1155 1285 1417 1321">16</td></tr> <tr><td data-bbox="628 1321 890 1357">12 < I ≤ 15</td><td data-bbox="890 1321 1155 1357">2.5</td><td data-bbox="1155 1321 1417 1357">14</td></tr> <tr><td data-bbox="628 1357 890 1393">15 < I ≤ 20</td><td data-bbox="890 1357 1155 1393">2.5</td><td data-bbox="1155 1357 1417 1393">12</td></tr> <tr><td data-bbox="628 1393 890 1429">20 < I ≤ 25</td><td data-bbox="890 1393 1155 1429">4.0</td><td data-bbox="1155 1393 1417 1429">10</td></tr> <tr><td data-bbox="628 1429 890 1464">25 < I ≤ 32</td><td data-bbox="890 1429 1155 1464">6.0</td><td data-bbox="1155 1429 1417 1464">10</td></tr> <tr><td data-bbox="628 1464 890 1500">32 < I ≤ 50</td><td data-bbox="890 1464 1155 1500">10</td><td data-bbox="1155 1464 1417 1500">8</td></tr> <tr><td data-bbox="628 1500 890 1536">50 < I ≤ 65</td><td data-bbox="890 1500 1155 1536">16</td><td data-bbox="1155 1500 1417 1536">6</td></tr> <tr><td data-bbox="628 1536 890 1572">65 < I ≤ 80</td><td data-bbox="890 1536 1155 1572">25</td><td data-bbox="1155 1536 1417 1572">4</td></tr> <tr><td data-bbox="628 1572 890 1608">80 < I ≤ 100</td><td data-bbox="890 1572 1155 1608">35</td><td data-bbox="1155 1572 1417 1608">3</td></tr> <tr><td data-bbox="628 1608 890 1644">100 < I ≤ 115</td><td data-bbox="890 1608 1155 1644">35</td><td data-bbox="1155 1608 1417 1644">2</td></tr> <tr><td data-bbox="628 1644 890 1680">115 < I ≤ 130</td><td data-bbox="890 1644 1155 1680">50</td><td data-bbox="1155 1644 1417 1680">1</td></tr> <tr><td data-bbox="628 1680 890 1715">130 < I ≤ 150</td><td data-bbox="890 1680 1155 1715">50</td><td data-bbox="1155 1680 1417 1715">0</td></tr> <tr><td data-bbox="628 1715 890 1751">150 < I ≤ 175</td><td data-bbox="890 1715 1155 1751">70</td><td data-bbox="1155 1715 1417 1751">00</td></tr> <tr><td data-bbox="628 1751 890 1787">175 < I ≤ 200</td><td data-bbox="890 1751 1155 1787">95</td><td data-bbox="1155 1751 1417 1787">000</td></tr> <tr><td data-bbox="628 1787 890 1823">200 < I ≤ 225</td><td data-bbox="890 1787 1155 1823">95</td><td data-bbox="1155 1787 1417 1823">0000</td></tr> <tr><td data-bbox="628 1823 890 1859">225 < I ≤ 250</td><td data-bbox="890 1823 1155 1859">120</td><td data-bbox="1155 1823 1417 1859">250</td></tr> <tr><td data-bbox="628 1859 890 1895">250 < I ≤ 275</td><td data-bbox="890 1859 1155 1895">150</td><td data-bbox="1155 1859 1417 1895">300</td></tr> <tr><td data-bbox="628 1895 890 1930">275 < I ≤ 300</td><td data-bbox="890 1895 1155 1930">185</td><td data-bbox="1155 1895 1417 1930">350</td></tr> <tr><td data-bbox="628 1930 890 1966">300 < I ≤ 350</td><td data-bbox="890 1930 1155 1966">185</td><td data-bbox="1155 1930 1417 1966">400</td></tr> <tr><td data-bbox="628 1966 890 2002">350 < I ≤ 400</td><td data-bbox="890 1966 1155 2002">240</td><td data-bbox="1155 1966 1417 2002">500</td></tr> </tbody> </table>	< ISO/AWG >			Test current A	ISO mm ²	AWG MCM	0 < I ≤ 8	1.0	18	8 < I ≤ 12	1.5	16	12 < I ≤ 15	2.5	14	15 < I ≤ 20	2.5	12	20 < I ≤ 25	4.0	10	25 < I ≤ 32	6.0	10	32 < I ≤ 50	10	8	50 < I ≤ 65	16	6	65 < I ≤ 80	25	4	80 < I ≤ 100	35	3	100 < I ≤ 115	35	2	115 < I ≤ 130	50	1	130 < I ≤ 150	50	0	150 < I ≤ 175	70	00	175 < I ≤ 200	95	000	200 < I ≤ 225	95	0000	225 < I ≤ 250	120	250	250 < I ≤ 275	150	300	275 < I ≤ 300	185	350	300 < I ≤ 350	185	400	350 < I ≤ 400	240	500
	< ISO/AWG >																																																																					
	Test current A	ISO mm ²	AWG MCM																																																																			
	0 < I ≤ 8	1.0	18																																																																			
	8 < I ≤ 12	1.5	16																																																																			
	12 < I ≤ 15	2.5	14																																																																			
	15 < I ≤ 20	2.5	12																																																																			
	20 < I ≤ 25	4.0	10																																																																			
	25 < I ≤ 32	6.0	10																																																																			
	32 < I ≤ 50	10	8																																																																			
	50 < I ≤ 65	16	6																																																																			
	65 < I ≤ 80	25	4																																																																			
	80 < I ≤ 100	35	3																																																																			
	100 < I ≤ 115	35	2																																																																			
	115 < I ≤ 130	50	1																																																																			
	130 < I ≤ 150	50	0																																																																			
	150 < I ≤ 175	70	00																																																																			
	175 < I ≤ 200	95	000																																																																			
	200 < I ≤ 225	95	0000																																																																			
225 < I ≤ 250	120	250																																																																				
250 < I ≤ 275	150	300																																																																				
275 < I ≤ 300	185	350																																																																				
300 < I ≤ 350	185	400																																																																				
350 < I ≤ 400	240	500																																																																				

Standards

3. KSC IEC 60947-4-1 Standard Description

Item	Standard description contents		
Connection capacity	<p>Similar relation with ISO of conductor sectional area and ISO sectional area except for the size written above is applied on both tables refer to the following.</p> <p>Standard sectional area of ring-shaped conductor</p>		
	ISO Section (mm²)	AWG / MCM	
		Size	Related section (mm²)
	0.2	24	0.205
	-	22	0.324
	0.5	20	0.519
	0.75	18	0.82
	1	-	-
	1.5	16	1.3
	2.5	14	2.1
	4	12	3.3
	6	10	5.3
	10	8	8.4
	16	6	13.3
	25	4	21.2
	35	2	33.6
	50	0	53.5
	70	00	67.4
	95	000	85
	-	0000	107.2
120	250 MCM	127	
150	300 MCM	152	
185	350 MCM	177	
240	500 MCM	253	
300	600 MCM	304	
<p>Reference) (-) from the table is calculated with the size considering connection capacity.</p>			

4. Acquisition Standard Table

January 2009 standard

Type	Device type	Approval					Verification	Certification of marine classification association					
	Abbreviation	IEC	UL & CSA		Safety cert	GB	IEC	KR	LR	BV	NK	ABS	DNV
	Mark												
	Region	Europe	America	Canada	Korea	China	Netherlds	Korea	England	France	Japan	America	Norwa
MC	MC-6a	●	●	●	●		●	○	○	○		○	○
	MC-9a	●	●	●	●		●	○	○	○		○	○
	MC-12a	●	●	●	●		●	○	○	○		○	○
	MC-18a	●	●	●	●		●	○	○	○		○	○
	MC-22b	●	●		○		●	○	○	○		○	○
	MC-32a	●	●	●	○		●	○	○	○		○	○
	MC-40a	●	●	●	●		●	○	○	○		○	○
	MC-50a	●	●	●	○		●	○	○	○		○	○
	MC-65a	●	●	●	●		●	○	○	○		○	○
	MC-75a	●	●	●	○		●	○	○	○		○	○
	MC-85a	●	●	●	○		●	○	○	○		○	○
MC-100a	●	●	●	●		●	○	○	○		○	○	
MT	MT-12	●	●	○	●		●	○	○	○		○	○
	MT-32	●	●	●	●	●	●	●	●	○		●	○
	MT-63	●	●	●	●	●	●	●	●	○		●	○
	MT-95	●	●	●	●	●	●	●	●	○		●	○

● Approved ○ Estimated Approva

Memo

Memo

Memo



**Name of Document : Metasol Magnetic Switch
Technical Manual
(Installation and Handling)**

Number of Document : Technology MS 695-009

**Issued by : Technology Management Team
Production & Technology Group
LSIS Co., Ltd.**

Total number of document printed : 200

Issued date : 2011. 06

The contents of this manual are subject to change without notice.
It is clearly prohibited from copying and development without permission.
If it's violated compensation will be required. This document is
covered by copyrights and device patents rights.

Green Innovators of Innovation



Safety Instructions

- For your safety, please read user's manual thoroughly before operating.
- Contact the nearest authorized service facility for examination, repair, or adjustment.
- Please contact a qualified service technician when you need maintenance. Do not disassemble or repair by yourself!
- Any maintenance and inspection shall be performed by the personnel having expertise concerned.

LSIS Co., Ltd.

© 2009.12 LSIS Co.,Ltd. All rights reserved.

www.lsis.biz

■ HEAD OFFICE

LS Tower 1026-6, Hoggye-dong, Dongan-gu,
Anyang-si, Gyeonggi-do 431-848, Korea

Tel. (82-2)2034-4887, 4873, 4148

Fax. (82-2)2034-4648

■ CHEONG-JU PLANT

Cheong-Ju Plant #1, Song Jung Dong, Hung Duk Ku,
Cheong Ju, 361-720, Korea

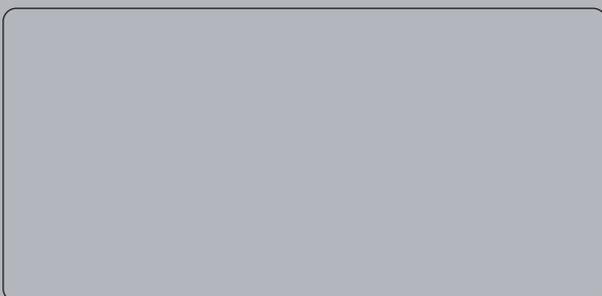

Specifications in this catalog are subject to change without notice due to continuous product development and improvement.

■ Global Network

• LSIS (Middle East) FZE >> Dubai, U.A.E.

Address: LOB 19 JAFZA VIEW TOWER Room 205, Jebel Ali Freezone P.O. Box 114216, Dubai, United Arab Emirates
Tel: 971-4-886 5360 Fax: 971-4-886-5361 e-mail: hwyim@lsis.biz

• Dalian LSIS Co., Ltd. >> Dalian, China

Address: No.15, Liaohexi 3-Road, Economic and Technical Development zone, Dalian 116600, China
Tel: 86-411-8273-7777 Fax: 86-411-8730-7560 e-mail: lixk@lsis.com.cn

• LSIS (Wuxi) Co., Ltd. >> Wuxi, China

Address: 102-A, National High & New Tech Industrial Development Area, Wuxi, Jiangsu, 214028, P.R.China
Tel: 86-510-8534-6666 Fax: 86-510-522-4078 e-mail: xuhg@lsis.com.cn

• LS-VINA IS Co., Ltd. >> Hanoi, Vietnam

Address: Nguyen Khe - Dong Anh - Ha Noi - Viet Nam
Tel: 84-4-882-0222 Fax: 84-4-882-0220 e-mail: srjo@lsisvina.com

• LS-VINA IS Co., Ltd. >> Hochiminh, Vietnam

Address: 41 Nguyen Thi Minh Khai Str. Yoco Bldg 4th Floor, Hochiminh City, Vietnam
Tel: 84-8-3822-7941 Fax: 84-8-3822-7942 e-mail: sbpark@lsisvina.com

• LSIS Tokyo Office >> Tokyo, Japan

Address: 16FL, Higashi-Kan, Akasaka Twin Tower 17-22, 2-chome, Akasaka, Minato-ku Tokyo 107-8470, Japan
Tel: 81-3-3582-9128 Fax: 81-3-3582-2667 e-mail: jschuna@lsis.biz

• LSIS Shanghai Office >> Shanghai, China

Address: Room E-G, 12th Floor Huamin Empire Plaza, No.726, West Yan'an Road Shanghai 200050, P.R. China
Tel: 86-21-5237-9977 (609) Fax: 89-21-5237-7191 e-mail: jinhk@lsis.com.cn

• LSIS Beijing Office >> Beijing, China

Address: B-Tower 17FL, Beijing Global Trade Center B/D. No.36, BeiSanHuanDong-Lu, DongCheng-District, Beijing 100013, P.R. China
Tel: 86-10-5825-6025.7 Fax: 86-10-5825-6026 e-mail: cuixiaorong@lsis.com.cn

• LSIS Guangzhou Office >> Guangzhou, China

Address: Room 1403,14F,New Poly Tower,2 Zhongshan Liu Road,Guangzhou, P.R. China
Tel: 86-20-8326-6764 Fax: 86-20-8326-6287 e-mail: linsz@lsis.biz

• LSIS Chengdu Office >> Chengdu, China

Address: Room 1701 17Floor, huanminhanjun international Building, No1 Fuxing Road Chengdu, 610041, P.R. China
Tel: 86-28-8670-3101 Fax: 86-28-8670-3203 e-mail: yangcf@lsis.com.cn

• LSIS Qingdao Office >> Qingdao, China

Address: 7B40,Haixin Guangchang Shenye Building B, No.9, Shandong Road Qingdao 26600, P.R. China
Tel: 86-532-8501-6568 Fax: 86-532-583-3793 e-mail: lirj@lsis.com.cn